

Australian Personal Computer

REGISTERED FOR POSTING AS A PUBLICATION — CATEGORY B
REGISTRATION No. VBP 3691. ISSN 0725-4115 NZ \$3.50 APRIL 1984

\$2.95

MSX
Basic, the
new standard?

AUSTRALIA'S TOP SELLING COMPUTER MAGAZINE

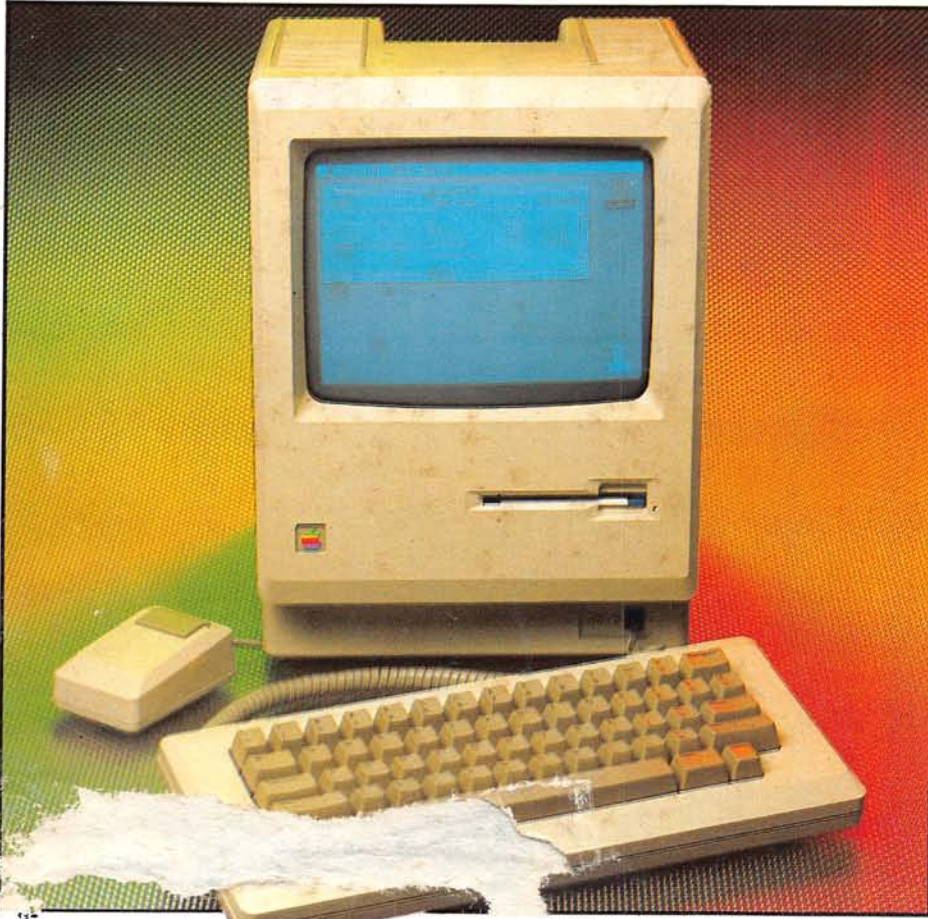

Macintosh — Apple's latest

**IBM
PORTABLE
PC**

Exclusive review!



Review: 2nd APC Show

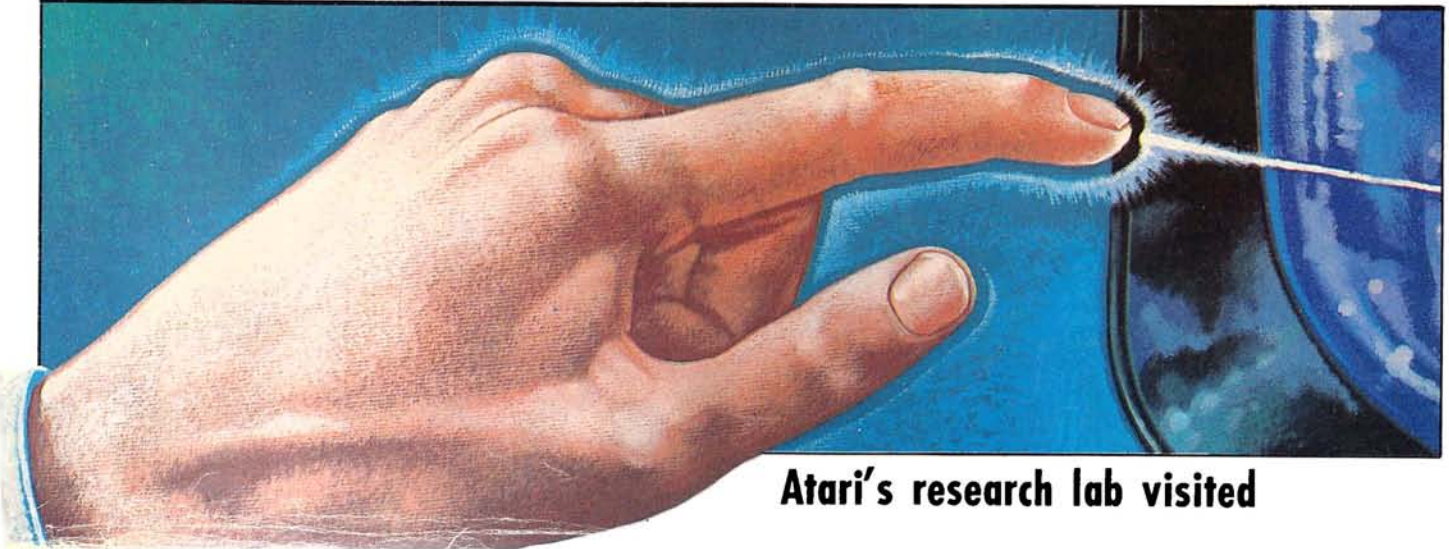

Atari's research lab visited

YES OSBORNE is Australia's Number 1

Yes! OSBORNE US has major innovations for the Executive!
 Yes! OSBORNE US has exciting new products under development!
 Yes! OSBORNE in Australia is substantially outselling its opposition!
 Yes! OSBORNE in Australia and the US will continue leading the world!



\$3198.00
TAX IS INCLUDED

**NOW 6 months warranty from
HILLS INDUSTRIES NATIONWIDE**

**Software worth
\$3600
all included in price**

Standard Hardware: • Z80A™ 4 MHz CPU with 128K RAM. • Real time clock inbuilt. • Dual floppy disk drives with 200K bytes storage each. Ability to read, write with IBM PC, DEC VT180, Xerox 821, Cromemco, and UCSD p-System Universal Disk Format. • 7" amber display CRT with reverse video, underscoring, blinking, two user-definable character sets, half intensity. • 24 lines of 80 characters each. 8x10 dot character cell matrix. • Business keyboard with numeric keypad and cursor control keys. • Video brightness and contrast controls on front panel. • 2 RS232 ports for modem and printer plus parallel printer port. • Baud rates from 50 to 19,200, software selectable. • Fully addressable IEEE488 port using a Motorola 6821 PIA. • Z80A SIO serial communications controller for synchronous and asynchronous communications. • Weather-resistant, portable housing. • Dual voltage 240/120V 50/60Hz 55W max. • Self diagnostics on power-up. • DMA (Direct Memory Access) port (internal). • Safety Certifications: IEC 380, UL, FCC, VDE, CSA.

Standard Software: • CP/M Plus (3.0) and UCSD p-System Operating Systems. • WordStar™ word processing with MailMerge™. • SuperCalc™ electronic spreadsheet. • Personal Pearl™ database system. • CBASIC™ programming language. • MBASIC™ programming language. • Extensive range of operating system utilities. INCLUDES complete and simple instructions for all hardware and software.

Yes! Full national 90 day warranty from Hills Industries in your Capital city.
 Yes! Spares, Service Contracts & full support also available. ***OSBORNE 1 — \$2,185 inc tax**

OSBORNE AUSTRALIA (02) 290 3344
 For nearest dealer and computer information see pages 88 & 89

Why wait for
IBM PC or XT . . .
call us now

**This
month's specials**

prices include sales tax

Lotus 1,2,3 **\$595.00**
Dbase II **595.00**
Quickcode **299.00**
Supercalc III **435.00**
Graphwriter **425.00**

Call for other items

IBM PC Disk drive Tandon .. **\$395.00**
Amdek MAI graphics
96K memory B/W or color **605.00**
ASD sixpack **425.00**
Hercules **595.00**
Sweet P Plotter **650.00**

- Star Gemini 10X • Brother HR15, HR25 • Olivetti typewriter/Printer Praxis
- Targa green/amber monitor • Targa color monitors.

**LOTUS 1,2,3
FREE**

with every Televideo PC and
Tele XT purchased

Completely IBM hardware and
software compatible

call

COMPLETE SOLUTIONS
(02) 331 6799

**Wanted
Computer
AUTHORS**

**For new computer
publication.
Regular contributors for
all aspects of computing
required.**

**For further details
please call
(02) 331 6792**

inside

Managing Editor Sean Howard; Consultant Editors Steve Withers, Ian Davies; Advertising Manager Gerard Kohne; Advertising Executive Philip Treyvaud; Art Director Mike Northcott; Typesetter Marcia Brown; Subscription Manager Valerie Meagher. Printed by Quadricolor Industries Pty Ltd. Subscription rates: Australia \$35.00 per annum, Overseas A\$47.00 (surface), A\$130 (airmail). Published by Sean Howard Productions, 77 Glenhurlty Rd, Elwood, Vic 3184. Telephone: Advertising (03) 531 8611, Editorial and Publishing (03) 531 8411. Telex: AA 30333 AMJ. Material contained within *Australian Personal Computer* is protected under the Commonwealth Copyright Act 1968. No material may be reproduced in part or whole without written consent from the copyright holders. Produced under licence from Computing Publications and VNU Business Publications B.V.

REGULARS

4 NEWSPRINT

The true price of the multi-user systems, Lotus announces its sequel to 1-2-3, Osborne's new micro and the FBI's fight against computer crime.

75 COMMUNICATIONS

Stimulating diatribes from trenchant readers.

97 SUBSCRIPTIONS

Apply now for a bundled-in copy of Peter Rodwell's *Personal Computer Handbook*.

101 BRAINDUMP

Let's have some innovation in the software industry.

105 DIRECT ACCESS

Includes a full and revised User Groups Index, Micro Exchange, Benchmarks and Diary Data.

112 TJ's WORKSHOP

Hints and tips from readers for your micro.

118 NEWCOMERS

Try our even friendlier introduction to what computers are all about.

129 NUMBERS COUNT

Some nostalgia on number theories.

131 BIBLIOFILE

Mr Withers once again purveys the world of micro books.

145 SUB SET

Assembler subroutines to help you get more out of your machine.

157 NETWORK NEWS

New bulletin boards and the jargon decoded.

165 LAZING AROUND

Save this one for when you're up the creek without micro.

165 PROGRAMS

Includes listings for VIC-20, Commodore 64, VZ-200, BB and MBasic.

182 BANKS' STATEMENT

Say goodbye to your familiar old telephone.

184 CHIP CHAT

Back at last! Gossip, libel, lies, half-truths and other interesting information.

184 AD INDEX

Find your way through the ads with this alphabetical list of advertisers.

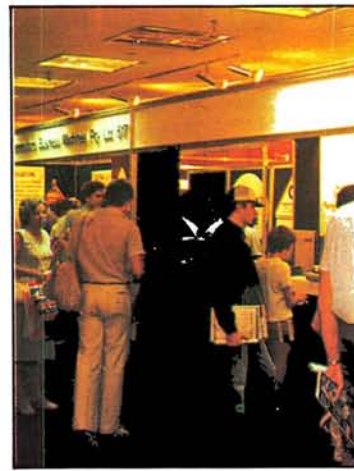

FEATURES AND SERIES

17 TEACH YOURSELF ASSEMBLER

This month looks at alternation as a building block in assembler programming.

21 BEGINNER'S GUIDE TO PROGRAM CONVERSION

Details of graphics and sound on the TRS-80, System 80 and Apple II.

31 BRING A MICRO

The machine takes on a new role in game playing. Get it to keep your score, and prompt you when you fall asleep between turns!

25 PROFILE: "THE MOST EFFICIENT SOFTWARE PRODUCER IN THE WORLD"

Bill Gates at the 2nd APC Show.

47 MICRO CHESS

Discover a fascinating new role for your micro, plus results of the 4th World Chess Championships.

150 THE AGE OF REASON

The guise of future programming? Logo and Gesture in focus. Inside Atari's research laboratory.

BENCHTESTS & REVIEWS

26 MACINTOSH

Apple's bid to revitalise the company. This portable and powerful machine is part of the Lisa 'family' and employs user-friendly icons.

41 UNIQUE UNIX

Intro to the most widely used, multi-user operating system for micros. Powerful but unfriendly.

49 2ND APC SHOW

Wow! Two years in a row as the biggest PC Show Australia's ever seen. Steve Withers was there and brings us a comprehensive report on the event.

66 IBM PORTABLE PC

APC has done it again — specially flown in to give you the first review of IBM's newest addition to its micro range, the Portable PC.

121 VISIWORD PLUS

Visicorp's repackaged word processor includes a spelling checker. Ian Davies investigates.

135 SPECTRAVIDEO

The first machine to arrive in Australia featuring the aspiring standard MSX Basic.

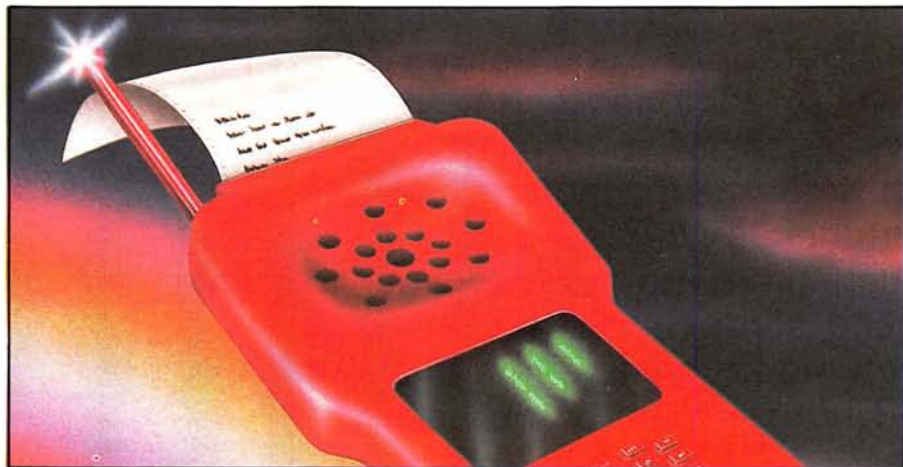

N • E • W • S • P • R • I • N • T

The very successful 2nd Australian Personal Computer Show hardly rates a mention in Newsprint this month — you'll have to see the extensive Show review elsewhere in this issue. But you can read all about the growth in the multi-user market.

Strategic move

A report categorising the IBM personal computer as 'too expensive to be used by more than a fraction of the

office workforce', suggests that multi-user microsystems are usually half the price per user.

Strategic Inc, author of the report which is based on the US market, reckons that an IBM personal computer with a local network linking it to

other IBMs in the same office works out at \$3000 to \$4000 per head — obviously including some kind of bulk-buy discount.

By contrast, multi-user machines such as those from Convergent Technologies, Burroughs (the same machine!), Molecular, NCR, Televideo, Onyx 'and a dozen or so other established suppliers', can put computing power onto a family of desks for around \$2000 per head.

For a report costing \$1500, it has missed the point by several feet.

Strategic suggests (quite sensibly) that 'potential end users of computer systems need to be reminded that IBM is not the only solution to be considered, and that other computer vendors are

viable and offer very competitive personal computing alternatives.'

The company quotes itself as a guinea-pig. 'Strategic itself has been able to save over \$40,000 by installing Televideo terminals on every employee's desk, and connecting them together via a Molecular Computer multi-user microprocessor system, as opposed to installing IBM PCs.'

But the fact that there are cheaper alternatives to the IBM can't be so much of a surprise to Strategic, that it feels obliged to part with the details only in exchange for \$1500!

And to be fair, it isn't. What the report does contain is a mass of statistics which any company manager would find useful,



We are looking for several enthusiastic games "freaks" to review the latest programs to hit the marketplace. If you own a home computer and feel you have the necessary writing skills to participate, write to the Assistant Editor, *Australian Personal Computer*, 77 Glenhuntly Road, Elwood, Victoria 3184. Please give details of your micro including amount of memory and any peripherals you own, and how much time you could devote to killing klingons on APC's behalf each month (a minimum of about 6-8 hours would be necessary).

The Editors



Pictured here withstanding an earthquake is a tiny terminal from Televideo. The Personal Terminal is aimed, according to ADE who provided us with the picture, at "the fast growing market for middle and upper management who primarily need to access data information" (as opposed to someone who does a great deal of data entry). It sells for under \$800. Details on (03) 544 3444.

ONE OF THE HIGHEST QUALITY SCREENS IN AUSTRALIA NOW HAS EVEN MORE TO OFFER



THE AMUST BMC 12ES

The BMC 12ES green phosphorus monitor from Amust. With 18 megahertz performance and 12 inch high resolution screen, the BMC 12ES

is one of the finest Japanese built monitors available in Australia. And now it has even more to offer. Because right now you can purchase an Amust BMC 12ES at an incredibly low price – but only while current stocks remain available.

For the finest quality, at a surprising

SPECIAL!

Purchase a new BMC 12ES monitor and you can also buy this adjustable monitor stand normally priced at \$49.95 for just

\$19.95

**HURRY: OFFER
LASTS ONLY WHILE
CURRENT STOCKS
ARE AVAILABLE**

low cost, contact your nearest Amust Dealer very soon.

IN A WORLD OF UNCERTAINTY, THE CORRECT DECISION IS AMUST.



Amust COMPUTER CORP.

For full details contact the Amust Distributor in your state.

VIC. METRO: Compak Computer Shop 350 South Road, Moorabbin.
Telephone: (03) 555 9844

VIC. COUNTRY: Data Parts 11 Edward Street, Shepparton.
Telephone: (058) 21 7155 (Also at Albury, Bendigo & Ballarat.)

NSW: Andy Stenberg 7 Arcadia Street, Coogee.
Telephone: (02) 260 1249

ACT: Computech Shop 7, Benjamin Way, Church Centre, Belconnen.
Telephone: (062) 51 2525

S. AUST: Amust Computers (S.A.) 73 Manton Street, Hindmarsh.
Telephone: (08) 46 9329

W. AUST: Microbase Computers 422 Newcastle Street, West Perth.
Telephone: (09) 328 9544

QLD: Amust Computer (Qld) 2/6 Harvton Street, Stafford. Telephone: (07) 352 6355

N • E • W • S • P • R • I • N • T

showing where users of micro networks have had problems, and what sort of costs are ahead. And it shows how different manufacturers differ in their solutions.

But it fails to notice that

there really is a difference between the cost of a computer, and the cost of selling it.

And the cost of selling a computer in the mini-computer bracket includes the cost of paying a salesman. And salesmen have to

be trained.

The dealers of Commodore computers can tell a tale or two about this. Customers who know what they are about tend to ask irritating questions — questions like 'Why can't I just buy a 64 and a hard disk and an

80-column adaptor and that cheap word processor program and a cheap printer? They ignore the fact that the dealer would go bust trying to pay his salesman's commission out of that sort of deal.

As long as the cost of

TANDY MODEL 4 \$2795

A Logical Solution — TRS 80 Model 4

- ★ A complete Small Business and Personal Computer
- ★ Fully tested with RS232 Interface included
- ★ Two Disk drives built-in and fast "Memdisk" feature
- ★ 80 x 24 character display "key click" features and sound
- ★ 4MHz CPU, 64K RAM expandable to 128K
- ★ Parallel printer interface and software print spooler
- ★ TRSDOS 6.0 included, CP/M compatible (available now)
- ★ Model III mode allows full use of existing software
- ★ Easy to use and configure — only a single power print

JWR Systems offers the following for the Model 4

- ★ Information Business Manager complete accounting package **\$500.00**
- ★ CPM 2.2 or CPM plus **now available**
- ★ 6.0 plus TRSDOS 6 enhancement **\$59.00**
- ★ Model 4 Lazywriter wordprocessor **\$175.00**

Please write or call for details of availability and prices.

J. W. ROSS (Systems) Pty. Ltd
P.O. Box 200, Forest Hill Centre, Vic 3131
Telephone: (03) 233 7212

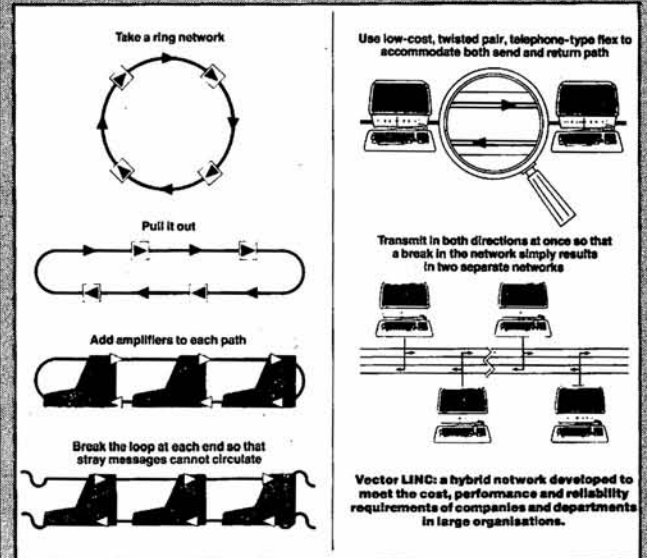

Vector once announced a local area network. Guess what: it linked micros together, not people. So if you wanted to send a message to somebody, you had to know which machine they were using.

Now 'electronic mail' has been added to LINC, Vector's network. You may wonder why that wasn't the first application for LINC, and the answer is: computer people don't think that way.

Details, for Vector owners, on (02) 27 6662.

THE INDEPENDENT MICROCOMPUTER GROUP

Supplies IBM, Apple, Nec and other makes of personal computers and peripherals for word processing, planning, record keeping, educational and personal applications, throughout Australia.

The Independent Microcomputer Group
Cnr George Street and Rawson Place
HAYMARKET NSW 2000. Phone: (02) 211 2666

The Independent Microcomputer Group
Cnr Elizabeth and McEvoy Streets
WATERLOO NSE 2017. Phone: (02) 698 7756

The Independent Microcomputer Group
Cnr Mary and Market Streets
BRISBANE QLD 4000. Phone: (07) 229 5377

The Independent Microcomputer Supply Company
21 Hindmarsh Square
ADELAIDE SA 5000. Phone: (08) 223 2505

The Independent Microcomputer Group
555 Collins Street
MELBOURNE VIC 3000. Phone: (03) 62 1339

The Independent Microcomputer Group
91 Brisbane Street
PERTH WA 6000. Phone: (09) 328 1299.

N • E • W • S • P • R • I • N • T

'training' is included in the price, single microcomputers will cost more than a terminal plus a share in a community micro.

And as long as that is true, people will buy multi-user micros for large departments.

But one day when the typical micro costs roughly the same as a typical terminal (and why shouldn't it? It's got screen, keyboard and some circuitry), people who want training will go out and buy it separately.

And, in the meantime, Strategic's consultants are quite right, and the multi-user market will grow.

I rather think however we will see the costs of stand-alone micros plus network coming down very heavily.

And we will see a boom in corporate training.

Guy Kewney

Smart writer

Single tasking micros can drive you up the wall when it's time to print out a large file. Several methods can be used to overcome this problem: buy a 16-bit micro running MS-DOS (which has a print spooling software feature); buy a printer buffer to connect between your micro and the printer (which is usually quite expensive); or buy a Daisy-writer 2000 printer which features its own 48k buffer.

This daisywheel printer's other features are pitch and line space selection, form length selection, true proportional spacing, the ability to centre and alter margins under software control and an unusual feature for a daisywheel printer, high resolution graphics (which is said to be compatible with Diablo's HYPLOT).

But its most important

feature, according to the distributors, is its ability to emulate other daisywheels including those from NEC, Qume and Diablo.

The Daisywriter has been selected as the official typewriter for the 84 Olympics.

Retail price is \$1986 plus sales tax. Further details are available on (02) 922 5322.



70Mb for IBM PC

A new 70 Mb hard disk/tape system for IBM PC, XT and compatible computers was launched at the Second Australian Personal Computer Show by Tallgrass Technologies.

Believed to be the biggest capacity hard disk/tape system available in Australia for personal computers, the new disk/tape system was unveiled in Sydney by Jim Worrell, Manager of International Marketing for Kansas-based Tallgrass Technologies Corporation.

"The newest model in our range of Winchester subsystems, the 70 Mb unit brings a new era of mass storage to the personal computer user", said Mr Worrell. "It provides a previously unavailable level of readily-accessible storage and should prove popular with businesses looking to multi-user applications."

"With so much data storage it's critical that efficient and reliable backup is available, and our integral cartridge tape backup unit

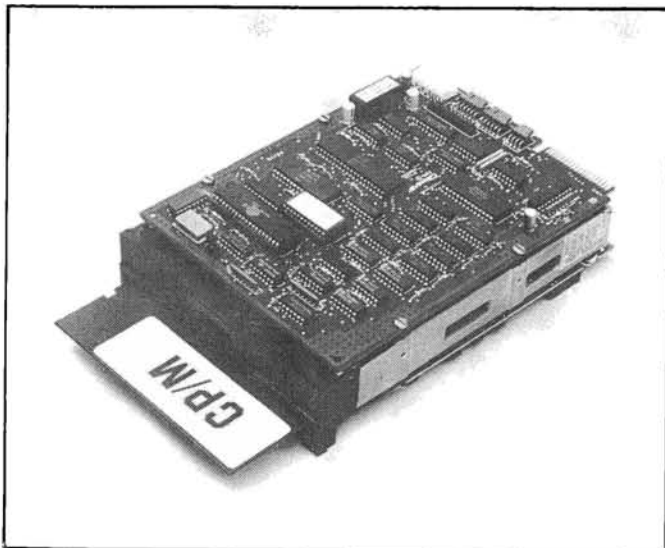

This is the \$399 Ampro Little Board CP/M computer. It's small enough to mount directly onto a 5 1/4" disk drive yet contains a Z80A CPU, 64k of RAM, 2 serial ports and one parallel port and a disk controller. The disk controller will operate 40 and 80 track drives, and single and double density and sided.

If you want to surprise your friends when your apparently isolated disk drive whirrs into action all by itself, then this is for you. It's also probably very useful if you're tight for room.

Details from ASP Microcomputers on (03) 500 0628.

TALK TO YOUR CLIENTS IN ANY LANGUAGE.



Application software is a word game. The real meaning is that if your client changes his micro software costs start all over again because most software is not portable from system to system.

The Conqueror Transcriptor is a format conversion machine which will give you that service edge your clients are looking for.

Discuss the wide range and scope the Transcriptor can give your store now, at under \$5k you owe it to yourself to get the facts.

A Transcription service is also available.



Speak your kind of language.

Commercial and Professional Microsystems.

9th Floor, 505 St. Kilda Road, Melbourne 3004. Tel. (03) 267 4755.

Brand Vic. CP 801.

BBC Microcomputer

The teaching computer

for those who have

done their homework

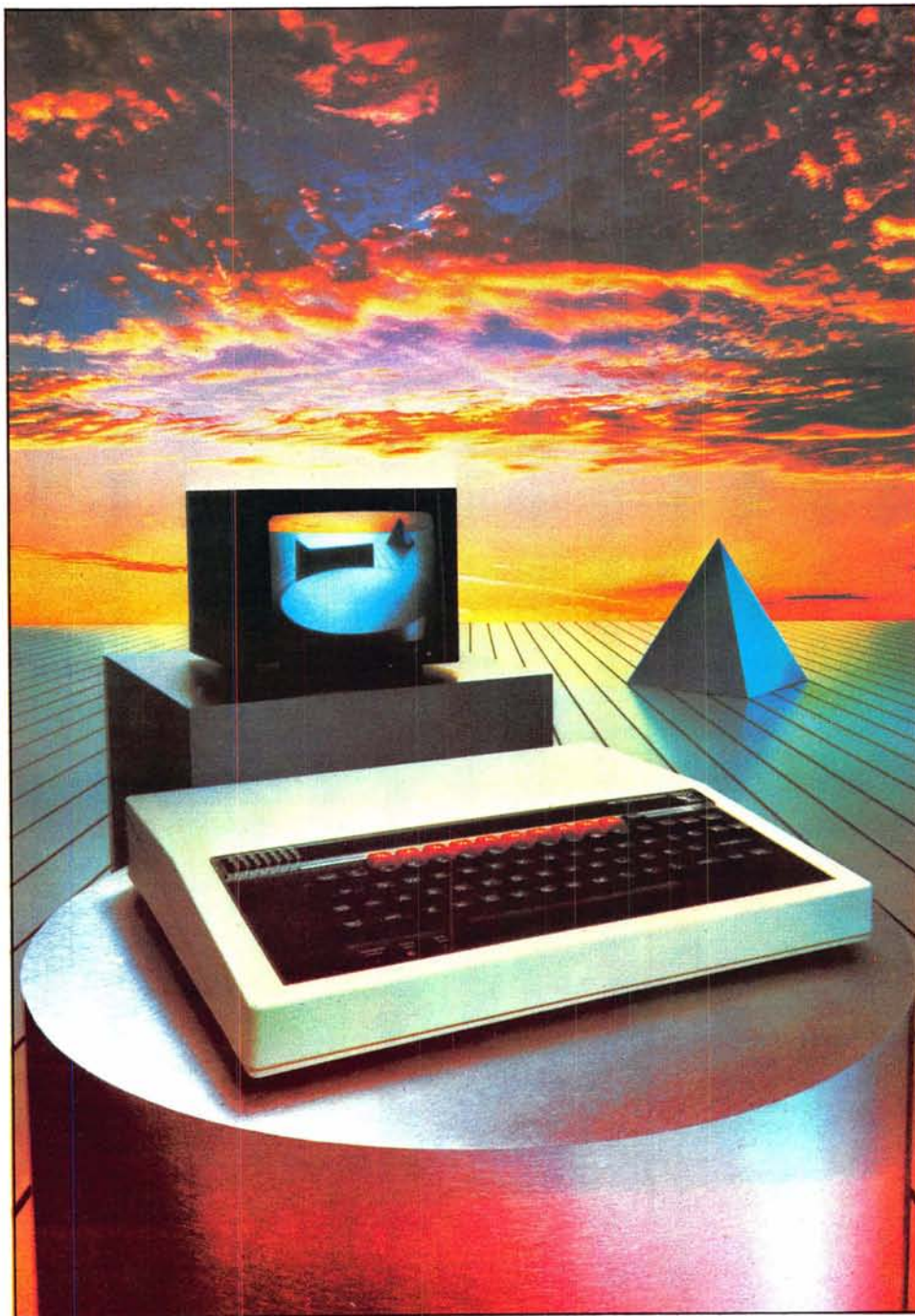

The BBC Microcomputer is the mainstay of the British educational system and will take their youth confidently into the 21st century.

The success of the BBC Computer Literacy Project is spreading rapidly across the world.

In Australia, a very large number of BBC school computer systems have already been installed in every state.

Why? Because 'The BBC' is not just an educational computer. It is one part of the British Government's project to produce the best microcomputer for education, plus the whole range of software and training aids needed to secure for youth the advantages of computer literacy in the coming computer age. Software abounds. The TV 'Computer Programme' has only begun. There is a wide variety of books and teacher aids. And the list grows constantly.

Australia is fortunate to be able to adopt the entire project without change — and to enjoy all the future developments. For the BBC Computer Literacy Project is ongoing. It will still be with us in the 21st century.

Of course, you are probably aware that Barson Computers were selected to distribute the BBC micro in Australia and New Zealand because they have the desired technical expertise, and are capable of giving BBC Microcomputer users a very high level of support indeed.

You see, the BBC did their homework, too.

BARSON
computers

To: Barson Computers Pty Ltd
335 Johnston Street, Abbotsford,
Victoria 3067

Please send me information on the
BBC Microcomputer and Software ticked
below.

Name

Telephone

Address

Postcode

- BBC Microcomputer
 Educational Software
 Games Software

1411/APC983

THE WORLD'S MOST EXCITING SCHOOL LIBRARY

When the BBC was assigned the task of producing a computer system for education, serious criteria were also established for the development of software

which would form the basis of education today, and on into the 21st century.

As a result, more quality educational software has been developed for the BBC Micro than for any other educational computer. Not for the BBC the 'structured reinforcement' (drill and practise) variety of software. Here are examples of subjects, for students of all ages, covered by the world's most exciting educational and recreational software library.

educational:

1

rawing. Painting.

ology

imal. Monohybrid/Dihybrid/Chromosome. Statistics for Biologists. Human Energy. Biology Pack. Pond Ecology. inspiration. Counter Current. Blood Sugar. Predator-Prey Models/Multifactorial Inheritance. Countercurrent Systems. mass Production. Flowering Experiment. Physiological Regulation.

Business and Business Studies

JType. VU-Calc. VU-File. Accounts 1 & 2. Business Games. Forecast. Payroll. Mailing. Cashbook. memo-Calc. Ledger.

Computer Learning

st Fleet Database. Factfile. Databas. Tree of Knowledge Graphs and Charts. Utilities 1. Lisp. Forth. The Classroom Who and You. Curriculum and the Micro. Building Ideas. eeping Learning. Home is where the chip is. Peeko Computer. The Computer Programmes 1 and 2. Acornsoft PL. Microtext. Bas. Procvar/Proc Flush/Proc Aid Computer procedures. Sort M/C. Sort Bas. Tas Logo. arch Bas.

Games and Educational Games

1 With Words. Doctor Who. Fun Games. Philosopher's Best. Monsters. Sphinx. Superlife. Adventure. Games of Strategy. Pirates. Snapper. Planetoid. Katakombs. Rocket d. Meteors. Super Invaders. Arcadians. Arcade Action. nes of Logic. Sliding Block Puzzle. Missing Signs. e Master. Chess. Time. Sailing Ships/navigation. n Campaign 1346. Disraeli 1875. Castle of Riddles. Starship n Command. Missile Base. Snooker. Draughts. Reversi.

Superlife. Battle. Cards. Hangman. Banner. Distances. Flags. Statpak. Countdown to Doom.

Graphics and Graphics Teaching

Shape Maker. Graphs and Charts. Creative Graphics. Eureka. Bar Charts. Moving Modules. Technical Drawing. Picture. Creative Graphics on the BBC Microcomputer.

General Educational Subjects

Educational I, Educational II. Results Analyst. Home Finance. Record Keeper. Desk Diary. Motorway. Farm Resources. Hill Railway. Rice Farming. Water on the Land. Prospecting. Light. Speed and Light. Urban Growth Stimulation. Urban Welfare. Census Analysis. Population Dynamics Transport/Manufacturing Location. Police. Diet. Map Skills 1 & 2. Balance Your Diet. Density and Circuit. Electrical Circuit. Symbols to Moles. Lenses. Approximation, Estimation and Standard Form. Longitudinal Waves. Climate. Compass and Bearings. Yacht Race.

French

Repondez. Comprenez.

Logical Thinking

Vennman. Vennkid. Shape. Gate. Watchperson. Spanish Main. Cat and Mouse. Logic Games. Concentration.

Language Arts

Early Learning. Word Hunt. Word Sequence. Sentence Sequence. Unscramble Spell. Pattern Recognition. Quiz. Anagram. Box/Wordshape. Dictionary Game. Vocabulary Practice. Hang the Man. Spelling Test Creation. List of Spelling Tests. Vocabulary Tester.

Mathematics

Fractions. Tables. Number Balance. Number Sequence. Maths Topics 1. Ultracalc. Algebraic. Manipulation. Trains/Arithmetic. Snap/Fractions. Ergo/Arithmetic. Morless/Number Concept. Abacus. Moving Modules. Multiplication. Speed Drills: Addition, Subtraction, Multiplication and Division. Read Speed Drills. Clear Speed Drills. Dice Addition and Subtraction. Long Multiplication. Area and Perimeter. Factor and Base Games. Equations, Pythagoras and Directed Number Games. Pythagoras Rule. Processes. Skill Counter.

Music

Music. Advanced Music.

Sciences

Evolution and Natural Selection. Particle Scattering. Genetic Mapping. Enzymic Kinetics. Homogenous Equilibrium. Gas Chromatology. Organic Synthesis. Decomposition. Sulphuric Acid. Synthesis of Ammonia. Element. Formulae. Gas Laws. Rates of Reaction. Reaction Kinetics. Compound Identification. Diet Analysis. Organic Analysis. Plant Competition, Photoelectric Effect. Mass Spectrometer. Planetary Motion. Gravitational Fields. Capacitor Discharge. Gaseous Diffusion. Radioactive Decay. Electric Impedence. Acoustics. Collisions. Momentum. Alpha/Range/Fraun/Decay. Chemical Analysis. Chemical Structures. Chemical Simulations. Atomic Structure/Equilibrium. Projectiles. Satellite Orbits. Orbits and Alpha Scattering. Exponential Growth and Decay. Alphafoil. Nuclei. Gravity. Quantum Shuffle. Random Walk. Ampere. Millikan. Malthus. Watts in Your Home. Moving Molecules. Photosynthesis. Metabolic Pathways. Wave Motion. Transverse Waves. Interference and Diffraction of Waves.

Spatial Perception

Shape Builders. Shape Shooter. What Shape. Axes of Symmetry. Crash. Perspective.

Word Processing

VIEW. Wordwise. Wordpack.

Note: The above describes existing cassette or disk software by title or content, and is a partial list only. Additional teaching aids including books, audio and video cassettes, tutors and OHP's, are all part of the BBC Computer Literacy Project. Software by Australian and International publishers and developers: Acornsoft, Advisory Unit, Cambridge Educational Software, Edward Arnold, Golem Software, Heineman, Input, Longman, Micro Primer, Passionfruit Software, Tas & WA Education Departments.

BBC / BARSON
MICROCOMPUTER / computers

Melbourne • Sydney • Auckland

N • E • W • S • P • R • I • N • T

has got this", he added.

The disk can be subdivided into up to five logical drives and can accept multiple operating systems (such as MS DOS, CP/M-86 and UCSD p-system) on separate partitions.

The new unit is network-ready, being compatible with industry available networks, such as PC Net and Ether Share.

Cost, including sales tax, is \$10,900 and the unit is available with a six month warranty.



New ideas for games

Ozisoft reckons it's got three of the best games ever released for the Commodore 64. They are Triad, a 3D

space game, Jumpin Jack, another 3D game this time in the "Frogger" style and Gridtrap, not in 3D but it sells for the same price as the first two, \$19.95, so it's presumably just as good.

Ozisoft claims each game includes "new and unique sound and graphic ideas". Details on (02) 211 1266



Disk debate as diameters diminish

By Serge Powell in Japan

Although the dust has yet to settle on the great VHS/Beta video battle it looks as though Japanese electronics giants are already mobilising

for the great storage drive contest.

With feints to the flanks from manufacturers in Hong Kong, Korea and Taiwan, the main thrust from Japan is the new format 3 or 3½in floppies, with the production of 5¼in drives simply a battle for manufacturing efficiency and economies of scale. This 5¼in business could turn out to be no more than a sideshow.

With the rewards at stake in the microfloppy arena, not to mention the profits from sourcing drives for US distributors to put to market, the players in the new format game are playing hardball.

At present the most promising talent is Sony, with a 3½in model that packs a punch of 1 Mb. IBM, Apple, Hewlett-Packard and NEC are all opting for the Sony format, and it looks like

Sony may regain some of the face it lost over Beta. But the Hitachi/Panasonic group hasn't fully unfurled its standard yet.

The Japanese scene is alive with rumours of a 3in 1 Mb drive, up from the 250k and 500k offered at present. But in the meanwhile you can watch the prices of 5¼in drives drift steadily downwards — OEM prices (for system builders) are now approaching the \$100 mark compared to \$500 last year.

If someone could just combine the capacity of the microfloppy with the pricing of the 5¼in model and couple the result to a decent RAM board we could all stop saving for a hard disk.

At the same time there are other peripherals to catch the eye. I came across one at the local Bit Inn, an NEC retail outlet that you might almost call a shop — in the way you might also call an embalmer a brewer and bottler.

It is called PO-10 and in some ways it is a hangover from a bygone era, when people believed — sensibly enough — that it might be more economical and reliable to get data into a computer through a mechanism that gave rise to the term Optical Character Recognition. In other words, you train the machine to recognise printed or typed characters and all that you do to enter data is put a sheet of paper in front of its scanner.

The PO-10 on show in the Bit Inn costs just over \$3,000, and for another \$100 you can add a utility that permits it to read documents in our language and create CP/M files. The PO-10 isn't limited to type-script: it can also handle hand printed characters — perhaps you would expect this for \$3,000, but believe me, the price is a remarkable

INFORMATION BUSINESS MANAGER



FULLY INTEGRATED ACCOUNTING

SYSTEM including:

- ★ DEBTORS
- ★ CREDITORS
- ★ STOCK CONTROL WITH INVOICING
- ★ GENERAL LEDGER



\$4160.00 (including tax)

A COMPLETE BUSINESS SYSTEM

- ★ 2.6 MEGABYTES OF DISK STORAGE (HARD DISK OPTIONAL)
- ★ CP/M 2.2
- ★ REAL TIME CLOCK
- ★ AUSTRALIAN DESIGN, LOCAL SUPPORT AND SERVICE
- ★ 280A 64K CPU EXPANDABLE TO 832K
- ★ 80 x 24 GREEN SCREEN TERMINAL WITH DETACHABLE KEYBOARD
- ★ NETWORKING UP TO 256 USERS
- ★ 12 MONTHS WARRANTY

DEALER ENQUIRIES WELCOME

A & M COMPUTER SOLUTIONS PTY. LTD (Incorporated in Victoria)
2 PROSPECT HILL ROAD, CAMBERWELL 3124. Telephone: (03) 813 3022

N • E • W • S • P • R • I • N • T

reduction on some of the units that have preceded it, mainly in the mainframe area.

It is hard to say exactly why it has taken so long for OCR techniques to percolate down to micro users in anything like a worthwhile form. The method dates back to computing's equivalent of the last Ice Age, and as you'll have noticed, where a method exists there is usually a research department or two trying to smarten it up.

OCR has frustrated many attempts to spruce it up, but the greatest drawback has probably been the price factor. Large mainframe users — the banks are good examples — find that the current techniques are adequate in certain applications, but that price restricts their use elsewhere. This is changing.

Besides, the price is bound to continue falling — unless OCR equipment starts a counter-trend by growing bigger, slower and more expensive. The type of device that is on the way is easily imagined — a reasonably priced OCR reader that will take a variety of type styles and sizes and

put the documents into files that can be edited and manipulated by word processors.

When these OCR machines are coupled up to the kind of laser disk filing system that is also just around the corner (perhaps by then OCR devices will be able to read round corners into the bargain) the prospects for office automation are considerable. In the first place, you may not need an office. I for one will welcome it.



Commodore multi-user system

The VIC-Switch is a multi-user system which can connect up to eight Commodore 64 or VIC-20 micros (or a mixture of the two types). The system was developed for educational use but, according to Commodore, has proved an outstanding success in business and club applications.

With a VIC-Switch, many micros can be connected to

a printer or disk drive simultaneously, the intention being to supply the maximum number of students with a complete computer system.

It is made in Sweden by Handic Software AB, and is sold by Commodore dealers.



BC-Basic for '64

A plug-in ROM cartridge for Commodore's 64 has been announced by Micromail. It provides 104 extra keywords (all with abbreviations) in the general areas of programming aids, hi-res

Zygotech presents

TALK ZBACK the communications package you have been waiting for

•overcomes machine to machine restrictions such as

- incompatible hardware protocols
- unknown I/O features
- incompatible disk formats

•does not have to be pre-installed on both systems

AND ALL THIS FOR ONLY \$230



For more information call 03-762-7103

or write to

Zygotech Pty Ltd.,
GPO Box 2647X
Melbourne 3001



Name

Company

Address

Phone No.

TALK ZBACK

BOOK KEEPER

BOOK KEEPER the brilliant "one stop" comprehensive Small Business System incorporating

- Accounts Receivable
- Accounts Payable
- General Ledger
- Stock Control

Available for all CP/M, MP/M, CP/M86, MP/M86 & MSDOS systems and all popular 5 and 8 inch formats

is still only \$700 for orders received by 30 April 1984



The VIC-Switch can connect up to eight Commodore or VIC-20 computers.

N • E • W • S • P • R • I • N • T

graphics, sprite commands and functions and sound generation commands. BC-Basic sells for \$80.

☐☐☐

UK PC lands here

Also from Micromail is the first computer released by a company which has previously concentrated on producing peripherals for Sinclair micros. It's called the Memotech MTX-512.

Specifications are a Z80A cpu running at 4 MHz (an option is a Z80B processor running at 6 MHz if you're a speed freak); the standard RAM is 64k which is internally expandable to 1/2 Mb;

24k of ROM allows for a powerful Basic which includes a 'logo' text manipulation language called MTX NODDY and an assembler/disassembler/monitor program; the 16k of RAM supports eight virtual screens (you can switch from one to the other) with maximum resolution of 256 x 192; sprite graphics are supported; on the storage side there's a floppy disk controller system which will run up to eight 5 1/4 or 8 inch drives or a HDX winchester system offering up to 10 Mb of on-line storage; and the system operates under CP/M 2.2. The 'get-in' price is \$799. Details from Micromail on (02) 449 5600

☐☐☐

When you get tired of playing games

Silicon Systems Software has just released an equine analysis program that will assist punters in their continuing battle against the bookies.

The program, Pastmaster, has taken three years to develop and uses the input of relevant past form for each thoroughbred. Finish position, weight, class, track condition and distance are analysed and adjusted against the parameters for the current race. The computer calculates "should be" odds and displays them with the required T.A.B. dividend

when the ranked horses are printed or displayed.

Pastmaster is available for Apple II and compatibles on disk, Tandy Color Computer on tape and disk (16k Ext), Tandy model I/III on tape and on CP/M (Multitech 501/504). Osborne, Kaypro and Morrow can be supplied by special arrangement. The program with its 14 page manual and Class cards for Australia and New Zealand is available for \$75 from Silicon Systems Software, P.O. Box 392, Portland, Victoria 3305. The program can also be downloaded through your modem.

A final thought: If this works why are they letting us (i.e. you, as readers, and us, as APC editors) in on the act?

☐☐☐



SANYO (FROM \$1495 INC TAX) PERSONAL/HOME COMPUTER. IBM COMPATIBLE



FEATURES

- 8088 Processor (16 Bit)
(Same as IBM/PC)
- MSDOS — (Optional CPM86)
- 128K RAM/Colour
- Dual 160K Drives
(Optional 320K)
- Green Screen Monitor

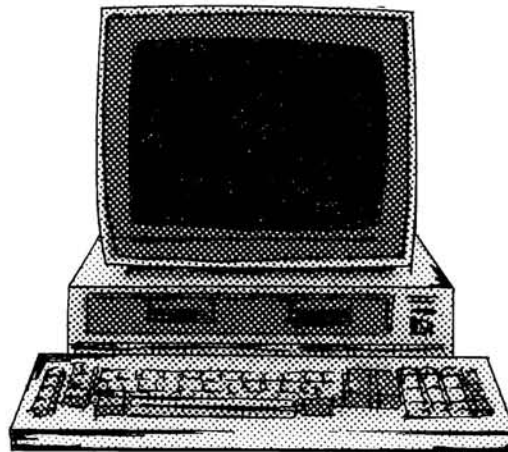

Software Package
Includes: Wordstar,
Mailmerge, Spellstar,
Datastar, Reportstar,
Supersort

(Normal price \$2600)
SPECIAL PRICE \$495

Melbourne's largest range of programs
Friendly expert advice and service
Easy access — plenty of parking

OPEN SATURDAY MORNINGS
Established 1968 — Member of O.E.I.A.

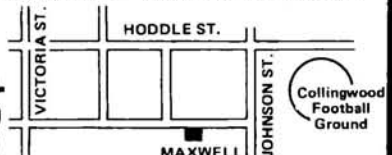

Maxwell OFFICE EQUIPMENT (VIC) PTY. LTD.
162-164 NICHOLSON ST. ABBOTSFORD
(near Hoddle Street) Telephone: 419 6811

New MultiMate

A new version of MultiMate was recently released which includes an 83,000 word dictionary.

Designed to emulate the Wang dedicated word processor, MultiMate operates on the IBM PC and compatibles. The latest version is said to be considerably faster than those previously distributed and supports a larger range of printers and bin-sheet-feeders for professional office tasks.

The new version sells for \$595 plus sales tax. Registered users of earlier versions are entitled to upgrade at a nominal charge.

Details from SCA Software Corporation on (03) 347 7011.



Kaypro's A4

The first of the IBM-compatible book-size micros looks likely to come from Kaypro, one of the most prominent portable micro makers.

A number of companies are known to be working on A4-sized machines that will run IBM software but Kaypro is set to beat them with its machine, built by Mitsui in Japan. The company has given no details of price or performance, but it announced in the US last month that it would be selling the micro this summer (our winter).

The Kaypro model will be roughly the same size as a Tandy Model 100 but with a bigger screen (80 by 16) and a bigger memory, perhaps as much as 256k.

Again in imitation of Tandy, the company will be supplying bundled business applications software — a word processor and a

spreadsheet will be included in the price. The degree of IBM compatibility is expected to take in Lotus 1-2-3 and the Microsoft Flight Simulator.



LINGO PC-128

Digital Source International has released a micro which claims Apple II and CP/M compatibility (it has two processors — a Z80A and a 6502). The LINGO PC-128 has 128k of RAM as standard — presumably that's why it's called the PC-128 — upwardly expandable to 1 Mb in 64k banks.

The machine is supplied with two 5¼ inch slimline drives, serial and parallel ports, colour graphics and six Apple II compatible slots. Details on (02) 690 1268.



Radio bla-bla

Radio University will start broadcasting a fourteen week course on programming in Basic from May 28.

Jim Murray, a lecturer at the University's Computing Services Unit explains that Basic is an ideal first computer language while "it can be used equally effectively as a high-level language for micro or mainframe computers".

Part 1 starts with an introduction to programming generally, and to Basic programming in particular, using personal computers and the Cyber computer system. It then works through programming examples, error diagnosis and debugging techniques. Part 2 is more technical, dealing with tab, character strings, sorting and comparison of strings and arrays, files, for-

UNITRON 2200 PERSONAL COMPUTER

★ IDEAL FOR EDUCATIONAL BUSINESS OR HOBBY USERS

DISK DRIVES SLASHED \$250 SHUGART or TEAC



This Syst Price \$1445 Includes 80 col card * 2 Drives Monitor Computer * Also available Single Disk Drive \$1245

* with 52 preselected functions
* 10 user definable keys
* auto repeat
Optional: IBM keyboard extra \$40

Computer Only \$695 Featuring:

- Dual micro processors 6502 and Z80A
- Dual disc drive controllers
- 5 expansion slots
- 64K Ram
- Selectable 80/40 column text
- Software Capabilities
Apple* software
CP/M* software

SUPER SPECIALS

Highly Competitive Prices on

e.g. Printer Interface \$60

DISC DRIVES

- Shugart \$250
- Teac Slimline \$250
- **doublesided SLIM**

MONITORS — EA (18 MHz)
— Unitron

CARDS

128K RAM, 8088 IBM, Z80 and 80 column, Language & PAL, Serial & parallel I/O, A/D & Eprom burner

Super Special Prices (for buys of 10 or more)

ONLY COMPUTERS

P.O. Box 387, Everton Park, Q. 4053
P.O. Box 280, Greensborough, Vic 3088
Adelaide: (08) 337-9820 Brisbane: (07) 351-1037
Melbourne: (03) 439-3751

- PLEASE SUPPLY Pamphlet with information
Computer package*
* Enclose cheque/money order plus \$12 delivery

Name.....
Address.....
Phone..... P/Code.....

*CPU & APPLE are trademarks of Digital Research & Apple Computers

**THE
 KING
 IS
 DEAD...**



**LONG
 LIVE
 THE
 KING!!!**

The Medfly was unquestionably the King of the Apple workalikes. It did everything the Apple could do and then more. And it was cheaper.

NOW THERE IS THE LINGO 128

- ★ **IT DOES ALL THE SAME THINGS AS THE MEDFLY AND THEN MORE**
- ★ **IT IS EVEN CHEAPER THAN THE MEDFLY**
- ★ **IT IS EVEN BETTER QUALITY**

Check the specifications on the basic machine. Make up your own mind.

	Lingo 128	Medfly	Apple IIe		Lingo 128	Medfly	Apple IIe
Twin processor	Y	Y	Extra	Cursor control pad	Y	Y	Y
Resident basic	Y	Optional	Y	Function keys	Y	Y	N
Standard memory	128K	64K	64K	Front on/off switch	Y	N	N
Built in whisper quiet drives	Internal	External	External	Japanese made	Y	N	N
Software selectable 80/40 column	Y	Y	Optional	External joystick port	Y	N	N
Hardware selectable 80/40 column	Y	N	N	Voice synthesiser included	Y	Optional	N
Centronics port	Y	Y	Optional	Price	\$1950		
RS232/C port	Y	Y	Optional	Cost of Medfly with 128k memory and two external drives		\$1860	GO ASK
Composite B/W video	Y	Y	Y	Custom ROMs (Optional) with resident Basic		\$115	it will scare the pants off you!
Composite PAL/NTSC	Y	Y	Optional				
TV UHF output	Y	Y	Optional				
RGB colour output	Y	Y	Optional				
6 Apple compatible slots	Y	Y	Y				
Upper/lower case	Y	Y	Y				
Numeric pad	Y	Y	N				
Auto repeat keys	Y	Y	Y				

The Lingo comes with Pascal, CP/M and Applesoft as standard.
 Prices include tax. Monitor is extra.
 Come to COMPAK where you can choose from the best!

© C. ITOH
© NATIONAL
© AMUST
© MEDFLY
© DISCOVERY

COMPAK
Compak Computer Centre

APRIL SPECIALS FROM COMPAK

For your Applethe Software Automatic Mouth

A brilliant voice synthesiser that can interpret intelligible speech from your written text. It even knows the difference between words like "through" and "rough". Phonemes too if you want to use them. Complete with manual and disk and hardware . . .



only **\$35**
including tax

Lockable disk boxes

Adjustable separators with index tabs
The same boxes are sold for twice the price elsewhere!

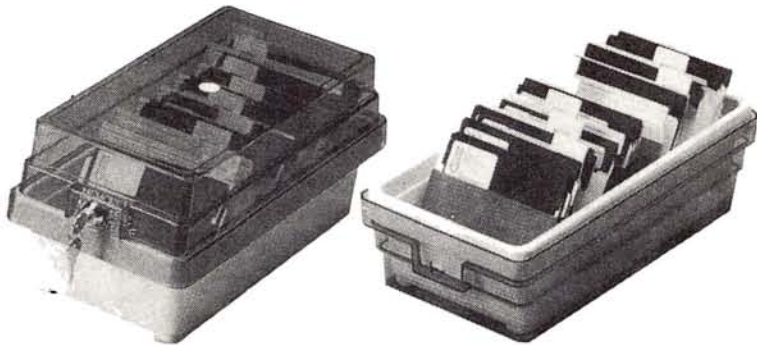

From Compak only **\$30**
Postage to capital cities **\$5**

NOW HEAR THIS!!!!

**COMPAK COMPUTER CENTRE SELLS THE AMUST DT80 PRINTER
AT THE BEST PRICE ON THE MARKET**

\$340 INCLUDING TAX

\$280 EXCLUDING TAX

QUOTE ME AN ADVERT
IN THIS MAGAZINE
OFFERING THIS PRINTER
AT A LOWER PRICE
AND I WILL BEAT IT
OR MEET IT!

Courier delivery \$8

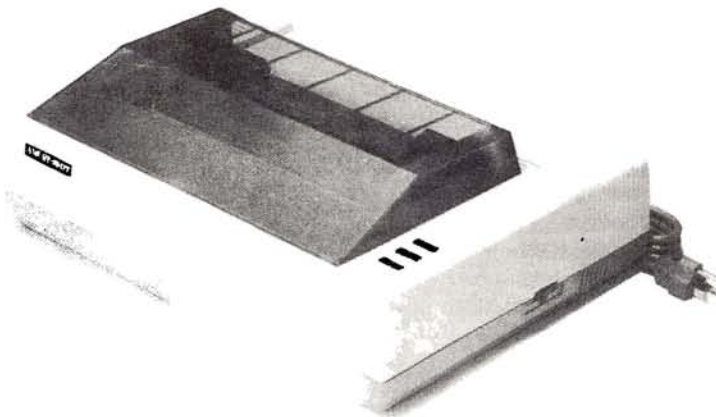

350 South Road, Moorabbin,
Vic 3189. Tel: (03) 555 9844

N • E • W • S • P • R • I • N • T

mats and records, plotting graphs, histograms and tables, and matrices. Part 3 expands on Part 2 topics and goes into files and access, memory limitations, applications software, and screen editing.

The broadcast course offers a combination of home study by radio, plus contact sessions at the University for tutorials, video lectures and use of University terminals for those who

do not otherwise have access to a computer.

"Programming in Basic" comes in three parts, giving beginners the option of enrolling in one part at a time to see how they get on. The fees for parts 1 and 2 are \$25 each for 5 radio lectures, 2 tutorials, and 2 video lectures per part. Part 3 consists of 4 radio lectures, 2 tutorials and 2 videos for \$22.50. Study notes are included in these

prices. The use of computing facilities three nights a week with supervision one evening costs \$6 per part as an optional extra.

The broadcast lectures are scheduled for 8pm on Mondays and repeated at 7pm on Thursdays. To receive Radio University, which transmits in the Sydney metropolitan area, a modified radio is required. Transistors with this modification are available from

the University at \$10 each, plus postage.

Cassettes of the radio and video lectures can be purchased through the University's Continuing Education Cassette service at \$8 per lecture for the audio tapes, and \$30 or \$50, according to the choice of format, for each video tape.

For details contact Radio University by phone on 662 2691, or write to P.O.

VIEW FROM AMERICA

Trail cools as FBI moves after hackers

By Chris Rowley

Certain types of right-wing Americans derive considerable satisfaction these days from the Soviet Union's total inability to join the micro revolution. October Revolutions are all very well but micro revolutions are beyond them.

The apocryphal story of the unfortunate Russian grocery clerk who got five years for possession of a mere mimeograph machine is currently popular here, along with guffaws at the Government licence required by prospective Soviet type-writer owners.

Ironically such an easy method of social control would probably find support today in staunchly anti-Communist ranks of the FBI, where they are having to deal with the Hydra-headed monster called 'Computer Crime'.

Agents have studied white-collar computer crime for years at the FBI academy in Quantico, Virginia. However, the courses have concentrated on old-style embezzling-type crime on mainframe systems. The new reality of modem-wielding micro users roaming Department of Defense data banks in search of adventure caught the Bureau flat-footed last year. But the FBI is making a strenuous effort to come to grips with this unexpected outbreak of anarchy.

To this end, 6,000 new Burroughs micros have been purchased and there are refresher courses for the agents, dummy bulletin boards to trap the indiscriminate hackers, sting operations to hit software pirates, and widespread recruitment of informers in sensitive US computer centres.

But it's questionable whether the FBI can ever catch up. The determined hackers have gone under-ground and sophisticated criminals using top-of-the-line micros are proving very hard to trap. Someone in a motel room in Idaho can steal information from a bank in New York over a phreaked (illegally used) phone line and then sell it to someone in Los Angeles. Even locating such a criminal is next to impossible. In fact, even the most routine technological advances continue to embarrass the Bureau; for example, its radio channel (titled KGB/770)

was monitored by criminals with quality FM scanners — listen to the Feds all day and you're bound to hear something worth money to somebody. As a result agents' lives were threatened and major operations exposed. The FBI finally switched to coded transmissions, but of course where there is a code there is a determined hacker, so the codes will have to be changed constantly.

Small pay-off

Meanwhile there is still no federal law against computer crime as such. Thus, in the case of the 414s who broke into mainframes all over North America last summer for kicks, laws directed at harassing or obscene phone calls were used to bring misdemeanour charges against two 21-year-olds. They pleaded guilty and are expected to receive small fines.

It isn't much of a pay-off for a case that had several agents working on it for weeks and which generated embarrassing media interest. Some critics of the agency's efforts say computer crime is basically a matter of lazy management and Crazy Kids should be treated as a minor problem. But the prospect of complete home phreaking hacker anarchy does have many authorities (especially AT&T) in something of a panic. There are kids with a Mount Everest complex out there who spend hours each day picking away at Defense Department computer defences.

There are bulletin boards with Citibank account codes for sale. Non-prosecutable teens breaking into foreign computers, the theft of corporate information concerning stocks and shares, the possibilities for the future of this sort of thing seem limitless.

Already the use of blue boxes for long-distance phone phreaking is said to cost more than \$100 million and the market in pirated software downloaded over phreaked lines is put at \$200 million. Without the KGB's sort of power and influence how can the poor old FBI ever get this particular genie back in its bottle?

Box 1, Kensington, 2033.



All in the mind

A Californian has come up with what could be the last word in how to sidestep computer keyboards — his Apple works by thought transference.

Robert Dilts' system makes mice look pedestrian and even leaves touchscreens in the shade. Thought takes practice but after a while you can achieve what amounts to close cursor control just by thinking about it.

He demonstrated it on an Apple IIe last week, but versions for Commodore and Atari systems are also being developed. It has serious applications: the potential for the disabled is clear, but the way it operates also suggests its use as therapy for anybody prone to such modern ailments as stress.

'It's amplifying changes in your skin conductivity', says Mr Dilts. Your physical contact with the machine is made by laying two fingers on a mouse-sized Galvanic Skin Response (GSR) unit that plugs into the joystick port. The rest of Mr Dilts' system is software to read the input and to run a series of demonstration programs in which, by sheer force of character, you orientate a line of dots, pilot a spaceship over an obstacle, and other exercises that under normal circumstances would be quite commonplace.

Mr Dilts' company Behavioural Engineering, of Scotts Valley, California (0101-408 438 5649) hopes to sell the system soon for around \$150. Meanwhile development continues: 'We are working on ways of making it more

controllable,' he says. This not only extends the possibilities in games, but also increases the potential of the system for revealing more about the personality and state of mind of the user.

It isn't biofeedback and it isn't exactly mind over matter. It should find a ready audience for its novelty value alone — cursor control without wires is a very strange sensation — but the long term value to the disabled should ensure that this technique doesn't languish.



Lotus adds lost chord

How do you follow an act like 1-2-3? The Lotus Development Corporation, producer of last year's most successful software package, aims to do it with Symphony.

This is the name of its follow-up, which it claims will turn your IBM PC or XT into the workstation of the future. The whole world and his dog seems to have their sights on the work station of the future but from Lotus it may be a more convincing promise.

Symphony offers word processing, database management, spreadsheet and graphics capabilities in an integrated package. Coupled with a windowing system and extensive communications facilities, Lotus calls Symphony 'the most complete business productivity tool ever offered for the microcomputer market', but of course it would say that.

Really an extension of 1-2-3, Symphony will be available in Australia in July. The Australian price is estimated to be \$1,195. A trade-in deal for your old 1-2-3 (for registered owners

Apple 32 SuperMicros™

The Apple 32 SuperMicro family has matured into the most powerful and cost-effective group of computers available today. From the Macintosh personal computer to the Lisa 2, voted 1984 'Computer of the year', it represents the foremost in personal computing.

The common theme of each computer in the range is their amazing simplicity of operation thanks to the 'Mouse' and the superbly-written software. Now, with the release of the Macintosh personal computer and the Lisa 2, we can offer a complete range of first class solutions from as little as \$4000.

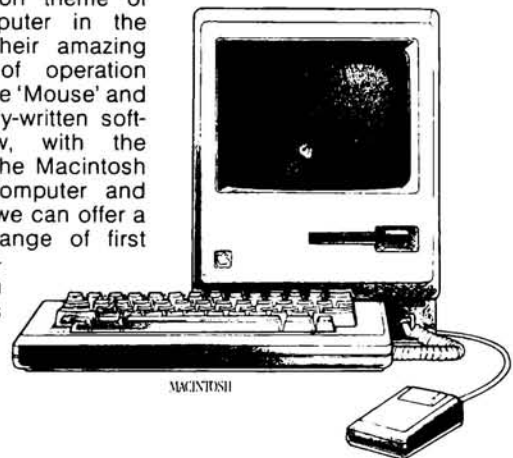

Among the software packages announced for the range are complete accounting packages, Lotus 123, dBase II, Unix operating systems, and literally hundreds of others.

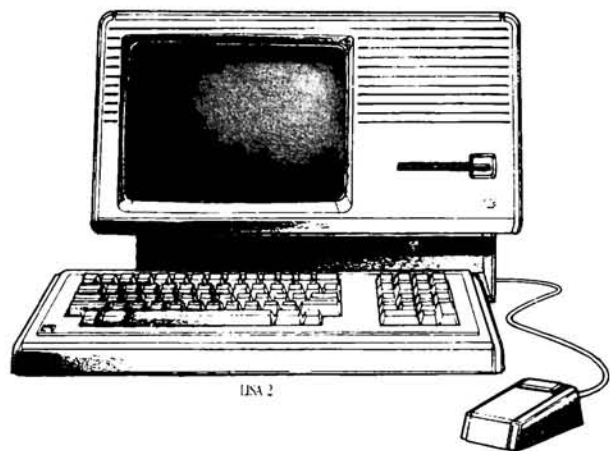

Of course these computers require the support of a first class supplier and in Sydney that means City Personal Computers, Sydney's oldest independent Apple dealer. We have by far the greatest experience of the Apple 32 SuperMicro range, experience that we will be delighted to use to support your requirements, both now and in the future.

North Sydney
2/100 Mount Street,
North Sydney NSW 2060
Ph: (02) 922 3600/922 7177

Sydney
55 York Street,
Sydney NSW 2000
Ph: (02) 29 2481/29 2462

**CITY
PERSONAL
COMPUTERS**

Rob's Computer

CARDS

RC MULTICARD

\$240 including Tax.
Expand your Hitachi's capabilities with this new Australian designed and manufactured board. Robs Computer center gives you for the first time on Hitachi

- **Two Joystick Ports.** compatible with Atari or Commodore joysticks.
- **Two Sound Generators** giving you 6 sound channels

- **Voice Synthesis Chip** lets your program speak to you.
- **Real Time Battery backed up Clock.** Keeps track of time and date even when power is off.
- **16 Input/Output Channels.** These are buffered T.T.L. level inputs and outputs that let you connect up to the real world and control your house lights, alarms and relays, etc.

Multicard
Money back
if not satisfied
within 14
days.



Price includes demonstration software, documentation, and programs necessary to implement all these features in a basic machine code program.

SUPERCHAMP JOYSTICK as shown \$29.95 Including Tax.
COMMODORE JOYSTICK \$12 Including Pack and Post Cards and Joysticks \$5 anywhere in Australia.

SOFTWARE SPECIALS

DBASE II **\$750**

Very powerful and widely accepted Database Program. Runs on Hitachi (with CPM), IBM and virtually any other computer

FBS **\$595**

Future Business Systems sophisticated Accounting package, Debtors, Invoicing, Creditors, and General Ledger. Both CPM and MSDOS.

PERFECT PACKAGES

to suit any C.P.M., Hitachi, or IBM compatible machine.

The whole lot **\$695**

PERFECT WRITER — Sophisticated word processor.

PERFECT SPELLER — Spelling checker for above.

PERFECT FILER — Store your information on Disk.

PERFECT CALC. — Powerful Spreadsheet program.

All **PERFECT PROGRAMS** interact with each other.

FRIDAY **\$395**

Produced by the same company as DBASE II. This latest package is simple to use and has a brilliant manual — it can also read and write Data from DBASE II, LOTUS 123, or WORDSTAR etc.

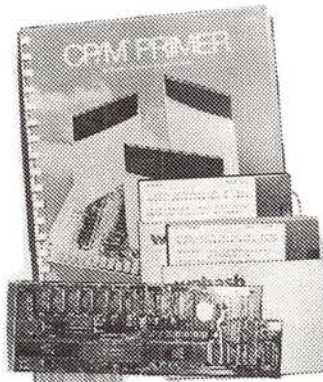

RC Z80 CPM CARD

- Plugs simply and easily into one expansion slot.
- Additional 64K Ram on the card.
- Reads and writes Kaypro 2 or 4 Disks.
- No modification required to Peach.
- Full Documentation supplied.
- Will run any standard CPM 2.2 Program. **\$495** including

STOP PRESS

NEW SOFTWARE VERSION

5.0 Reads and writes Osborne as well as many other Disk formats including Kaypro 2 and 4. **\$50** Upgrade to existing RC Z80 users.

ATTENTION HITACHI SUCCESS OWNERS!

The new RC 16000 Graphics card now allows you to run IBM colour graphics on your 16000 series computer. Now you can run Lotus 1, 2, 3, Wordstar 3.3; and virtually any IBM Graphics orientated programs. **AVAILABLE SOON**

Price includes Tax; installation instructions; freight and insurance to anywhere in Australia. **\$695**

NEW 5" DISK CONTROLLER BOARD RC 1802

The RC1802 has been developed in Australia, uses the latest Disk Controller Technology and has many advantages over the Hitachi types.

- **Runs any standard 5" drive** single or double sided
- **Runs double density HITACHI DOS**
- **No modifications to Peach**

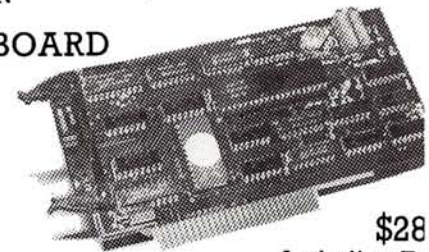

\$28
Including Tax

HI STAR DISK

For Hitachi Peach DS/DD

- **GRAPHICS AID** (HI-DRAW)
- **TYPING TUTOR** (HI-TYPE)
- **BASIC TUTOR** (Teaches you BASIC)
- **QUICK WRITER** (Simple On-Screen Letter Writer)
- **DISK UTILITIES** (Easy to use|Disk Utilities in English)

\$49.50 including Tax

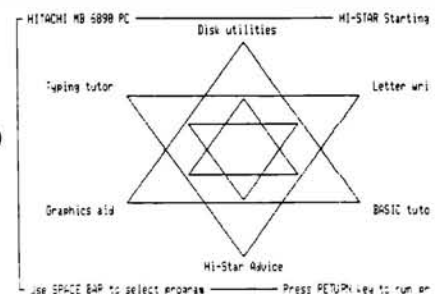

Center Specials

BROTHER HR 15 Daisy wheel printer.

- \$725 Parallel Version
- \$395 Sheetfeeder to suit
- \$295 Keyboard option
- \$165 Tractor feed to suit
- \$20 Printer cable

All prices include Tax

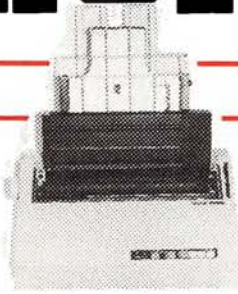

PRINTERS

**COMPUMATE CP80
PRINTER** Compatible with Epson FT type III.
\$395 Including Tax.

JUKI 6100 DAISY WHEEL PRINTER.

Control codes are identical to Diablo Printer.
Including Tax and cable. **\$950**

BROTHER EP44 Plain or Thermal paper dot matrix printer

This latest technological marvel from Brother features virtual daisywheel quality printing. Use it as a stand alone typewriter with approx 4K memory. Suitable for use with Commodore 64 and virtually any other computer.

- \$395 including Tax.
- \$15 Cable
- \$25 Power pack

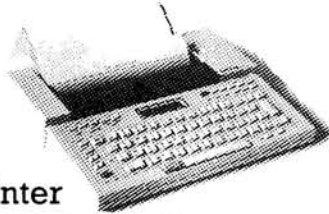

WP 1000 PRINTER

Heavy duty dot matrix printer.
120 c.p.s.

\$595
Includes Tax and cable.



Including Tax and cable.

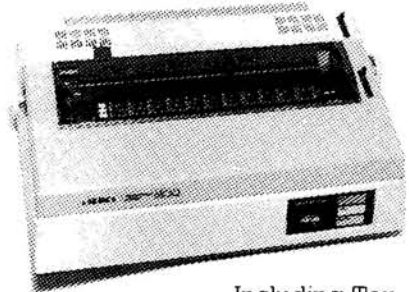

GENUINE HITACHI LIGHT PENS MP - 3700

We now have new stocks so if you missed out last time then this is your chance

WAS \$330 NOW **\$125** including Tax.

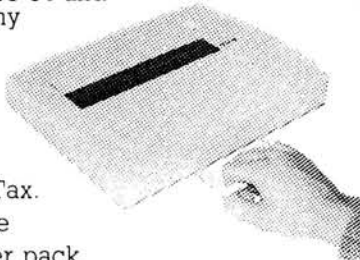

DISK DRIVES

NEW 5" DISK DRIVES FOR HITACHI PEACH

5.25" DS/DD DRIVES 320K per drive.
\$295 including Tax



These are Hitachi Disk Drive packages in an Australian case with 1802 controller.
5.25" DS/DD DRIVE 320K formatted.
\$395 including Tax
prices include 1802 controller, free demo, games disk.

HITACHI 3" POCKET FLOPPY DISK DRIVE

Yes they have arrived
SS/SD Pocket floppy disk can be flipped over to write on both sides.
(i.e. 160K per disk)
Free Demo and Games Disk

WAS \$950 NOW
NEW LOW PRICE \$395 including Tax

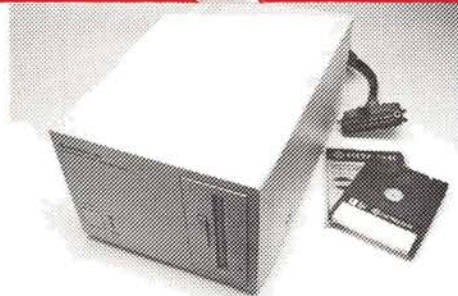

notas

COMPUTER CENTER

295 Thomas Street, Dandenong 3175
Phone (03) 7912900

Also available from: OFFICE UPDATE - PERTH Ph. (09) 325 3499
METROPOLE - ADELAIDE Ph. (08) 223 5538

N • E • W • S • P • R • I • N • T

only) will also be available, the upgrade cost being the difference in price between Symphony and 1-2-3 (about \$300).

The drawback is that you'll also have to lash out on a memory expansion for your micro, unless it's an XT.

Symphony needs at least 320k, but will run happily on a single disk system and can support up to 16 in-line displays.

The idea of such memory use is that you won't have to wait for programs or data to be loaded in from disk, as is

usual — the whole program will reside in RAM, making switching between the modules and data updating quick and easy.

Symphony provides a programming environment for developing dedicated applications programs via its

Command Language and Lotus plan to release 'add-in' applications such as time management and project scheduling to the open-ended system. These will become optional extras to the package.

The system has been

GET MORE OUT OF YOUR 8 BIT COMPUTER EXPAND TO THE WORLD OF CP/M 86 & MSDOS JOIN THE IBM-PC REVOLUTION THE CHEAPER WAY

**CP/M 86 & MS-DOS
for the TRS-80 I, III,
& IV, MAX-80, LNW**

MicroMERLIN

CP/M or MSDOS
RS232 Serial I/O
Centronics Parallel Port
Complete with Power Supply
and Enclosure
128K RAM **\$1350**
64K RAM **\$1195**

**CP/M 2.2 FOR THE
ATARI COMPUTERS**

ATR 8000

64K RAM with CPM 2.2
& MYDOS WAS \$995.00
SPECIAL \$885.00

**CP/M 86 & MS-DOS
for the following
computers: Atari using
ATR8000, Bigboard,
Kaypro, Osborne, Tele-
video 802, Xerox 820,
820-II and Zorba**

CO-POWER-88

128K RAM with CP/M 86
& MS-DOS WAS \$1250
SPECIAL \$1100.00
256K RAM WAS \$1350
SPECIAL \$1250.00

**CP/M 86 & MSDOS
for APPLE 2E and
virtually any Z80
based computer**

CO16

128K RAM **\$1250.00**

DISK DRIVES SPECIAL

TEAC DRIVES

77 Tracks **\$390.00**
40 Tracks **\$290.00**
80 Tracks **\$350.00**
Case & P/S 1 Drive **\$69.00**
2 Drives **\$99.00**

MONITORS SPECIAL

Yanjen Amber or Green
Screen including swivel
base (Hi-Res) **\$199.00**

DISKETTES SPECIAL

40 Tracks DSDD 48TPI
(10) **\$39.50**
80 Tracks DSDD 96/100TPI
(10) **\$49.90**

PRINTERS SPECIAL

ASTECH 100 CPS **\$499.00**
STAR (10) 120 CPS **\$520.00**
STAR (15) 120 CPS **\$950.00**
EPSON FX80 **\$710.00**
EPSON RX80 **\$520.00**

INTRODUCING MPS ACCOUNTING SOFTWARE

A Fully Integrated Management and Accounting System Designed in Australia for portable, personal and desktop computers.

This high-quality, reliable software was designed to be very flexible and easy to operate. It is user-friendly, completely menu driven and provides screen help facilities. It is easily adaptable to a wide range of businesses.

Feature-for-feature, and dollar-for-dollar it is the best software value on the market! The following modules are currently available at \$490.00 per module. (TOTAL PACKAGE **\$1,500.00**)

Accounts Receivable, Accounts Payable, General Ledger, Invoicing and Payroll.

Minimum System Configurations: 8 Bit or 16 Bit CP/M or MS/DOS with MBASIC, 2 Disk Drives and 48K RAM.

FOR MORE INFORMATION, OR FOR A DEMONSTRATION, OR TO PLACE AN ORDER, WRITE TO:

MICROPROGRAMMING

P.O. Box 475, MOUNT WAVERLEY, VIC 3149

OR CALL **560 8664** ASK FOR LOUIS BELCOURT

ALL PRICES INCLUDE SALES TAX

Micro MERLIN is a registered trademark of Micro Projects Engineering Inc. TRS-80 is a registered trademark of Tandy Corporation. MAX-80 is a registered trademark of LOBO Systems Inc. ATARI is a registered trademark of Atari Inc. ATR8000 & CO-POWER-88 are trademarks of SWP Microcomputer Products Inc. IBM-PC is a trademark of IBM. Kaypro is a trademark of Kaypro/Non Linear Systems. Xerox 820 and 820-II are trademarks of Xerox Corp. CP/M and CP/M 86 are trademarks of Digital Research Inc. MS-DOS is a trademark of MICROSOFT. Specifications and prices are subject to change without notice.

Where can you discuss your computing requirements without being frustrated by shoe salesmen transferred to the computer sales department for a week, or 17 year old computer whiz kids that have no experience in business?

Where do you go to find an authorised Apple dealer with 15 years experience in developing main frame computer applications?

Where do you go to find an authorised Apple dealer who's custom is to build almost entirely on word of mouth and is one of the fastest growing Apple dealers in Australia?

Where do you go to find an authorised Apple dealer that will discuss and demonstrate communications without confusing you with computer jargon?



LOGICAL SOLUTIONS

 **apple computer**
Authorized Dealer

87-91 REGENT STREET,
CHIPPENDALE, NSW 2008

(02) 699 4918

*Where will you go to buy your Apple Lisa™ or Apple Macintosh™
personal computer?*

DATA PARTS does it again!

INCREDIBLE COLOUR MONITOR!

'SCOOP' PURCHASE (CANNOT BE PURCHASED ANYWHERE ELSE IN AUSTRALIA)

● ADI-INTRA COLOUR MONITOR

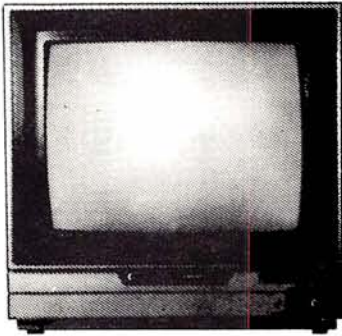

\$399 inc
\$339 exc
COLOUR MONITOR

Suits Commodore, Apple, etc.
(Manufacturers rec. retail price \$620).
RGB + Composite video

OR A

● HI RES GREEN SCREEN MONITOR SPECIAL

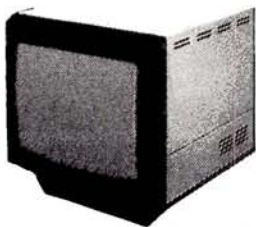

20MHZ
Cable, Manual, etc

\$189 inc
\$159 exc

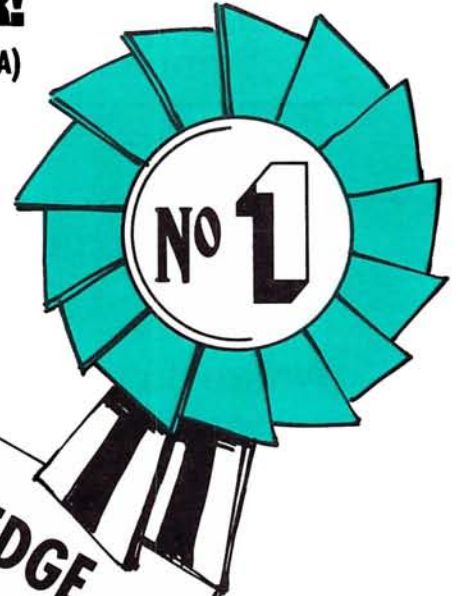

OUR PLEDGE

We absolutely guarantee to supply all our mail order customers the very best quality.

All mail order products are clearly and unconditionally covered by the Data Parts 6 months parts and labor warranty! (That means something — ask our customers).

Data Parts are one of the biggest and oldest mail order houses in Australia. We don't just claim to be the best... check our superb quality products... but still we are never undersold! And remember all products are delivered free to your door.

YES — FREE FREIGHT anywhere in Australia
Our operators are ready to take your order NOW!

Regards

Boyd Dainton
Boyd DAINTON

1000s of
The FAMOUS

★ AMUST DT80 PRINTER

80 characters second
Bidirectional printing
Crisp clear print style from squar
pins

Superscript/subscript
Graphics capability
Italics

Sprocket feed for fanfold paper
Pressure feed for sheet paper

\$298
exc
(\$338 inc)



ACT NOW!

PRICES APPLIABLE

ONLY ON CURRENT STOCK

PHONE YOUR BANKCARD NUMBER THROUGH NOW...

REMEMBER NO COSTLY FREIGHT CHARGES

DATA PARTS STOCK... COMMODORE, DIGITAL, NEC, OSBORNE + EPSON

DATA PARTS does it YET again!

PRICE BREAKTHROUGH

**\$268.00
(EXC)
(\$299.00 inc)**
Apple or Wombat
Compatible etc



TEAC-8 SLIMLINE

**SCHOOLS.
PHONE FOR YOUR
SPECIAL PRICES**

HARD DISK
10 MB includes 'CONTROLLER'
for Apple II, II Plus or Wombat etc
\$1995.00
(\$2395 INC SALES TAX)

MORE GREAT BUYING:— ALL THIS LOT INCLUDES:

*COMMODORE	Price (inc tax)	*IBM Software	Price (inc tax)	CABLES (Printer)	Price (exc tax)
1541 DISK DRIVE.....	\$380	WORDSTAR.....	\$480.00	Serial — serial.....	\$19.95
1526 PRINTER.....	425	DBASE II.....	580.00	Centronic — Centronic.....	29.95
1526 LOOK ALIKE PRINTER		LOTUS 1-2-3.....	695.00	MicroBee Cable.....	39.95
with Interface.....	398	KOALA PAD.....	169.00	IC Sockets.....	1 cent a pin
1701 MONITOR.....	425	GREEN SCREEN.....	189.00	(i.e. 28 pin is 28¢)	
64 COMPUTER.....	379	COLOR.....	399.00		
VIC-20 COMPUTER.....	178			*HOBBIEST ADD ONS	
1520 PLOTTER.....	278	*APPLE COMPATIBLE		(exc tax)	
SX64 PORTABLE.....	1298	64K — Z80/6502 CPU ...	549.00	MPI B51 Disk Drives.....	199.00
DATASET.....	48	Z80 CARD.....	84.50	MPI B502 Slim Line.....	289.00
KOALA PAD.....	129	SNAPSHOT CARD.....	99.00	Mitsubishi 4853.....	329.00
EASY SCRIPT.....	84	80 COL.....	98.00	Mitsubishi 4854.....	349.00
SIMONS BASIC.....	73	16K CARD.....	80.00	National D/S D/D.....	299.00
MOST CARTRIDGES... Programs ..	25	DISK CONTROLLER.....	60.00		
MOST CASSETTES ... Programs ..	14	PARALLEL PRINTER		*MEMORY COMPONENTS	
		CARD & CABLE.....	89.00	(exc tax)	
*PRINTERS		COOLING FANS.....	59.00	6116 RAM.....	5.88
DT80.....	\$339	POWER SUPPLIES.....	69.00	4116 RAM.....	1.49
EPSON RX80.....	439	JOYSTICKS.....	29.00	4864 RAM (any quantity)....	5.69
EPSON FX80.....	699	PADDLES (PAIR).....	39.00	2732 EPROM (any quantity)...	4.50
EPSON RX100.....	799			2764 EPROM.....	6.99
EPSON FX100 — PHONE					
TEC F10 DAISY WHEEL.....	1698			*SUPER SPECIAL	
PHONE ON				2716/2516.....	\$3.80
NEW COLOR PRINTERS					
*MONITORS				*DISKETTES	(inc tax)
NEC 15 MHZ Green.....	\$159			OUR BRAND Box of 10.....	29.95
BMC 18 MHZ Green.....	179			Datalife (the best) 525.01	
INTRA 20 MHZ Green.....	179			Box of 20 D/D.....	34.95
INTRA ADI Color				Datalife Double Sided	
(Composite & RGB).....	399			550.01.....	44.95
AMBER MONITOR HI RES		*OSBORNE 1		ALL OUR ACCESSORY PRODUCTS	
with Swivel Base.....	189	with D/D drives, 80 col card and all		CARRY A FULL 5 YEAR WARRANTY	
		the software.....	\$1895	Phone for items not listed.	

NEW

Would you like to be able to use all those great joysticks available on Commodore etc.

With the Datatech Interface unit you can use any joystick on your Apple II or lookalike. Datatech unit includes self centering controller and indicators..... \$16.95 (inc)

TRADE ENQUIRIES WELCOME

CASH/CHEQUE OR BANKCARD WELCOME HERE

DATA PARTS

MAIL ORDER CENTRE
11 EDWARDS STREET,
SHEPPARTON VIC 3630
Telephone: 21 7155 (058)

• SHEPPARTON (As Above) Telephone (058) 21 7155
• ALBURY 658 Dean Street Telephone: (060) 21 8080
• BENDIGO 27 Bath Lane Telephone: (054) 43 4866

• BALLARAT 307 Mair Street Telephone: (053) 31 3399
• MILDURA C and G Computers Telephone: (050) 23 6272

N • E • W • S • P • R • I • N • T

designed with international communications in mind; it incorporates the Lotus International Character Set, intended to allow simple translation of menus and other information including date/time and currency formats.

After 1-2-3, Lotus has a reputation as a trend-setter to maintain.



Come-back

So much for the theory that the Apple II was dead: the corporation has announced worldwide sales of over 100,000 IIs in December.

John Sculley, the president of Apple, attributed the sales to 'a reduction in price and strong dealer promotion programmes.' He also noted that the \$2.5 million paid by Franklin 'had been included as income'.

Sculley told me that another contributing factor, perhaps as important, had been the announcement of IBM's 'peanut' or PC Junior.

That machine failed to impress people who had been postponing the

purchase of their Apple, and they went ahead with the Apple.

The result was a first quarter revenue report showing sales up by 48% over the same quarter last year — though profits were heavily down at \$5.8 million compared with \$23.5 million for last year's first quarter.

Sculley insists that the high figures aren't just a flash in the pan. 'We will sell as many Ii machines as we sell Macintosh machines this year', he said.

Guy Kewney



IBM-compatible Osborne

Osborne has finally unveiled the IBM-compatible version, which it hopes to make in the UK. Probable release, if plans go ahead, would be around June/July.

The demonstration I saw was impressive enough up

to a point. The machine would load and run any program — provided it didn't use the P-system. Then quirks of the IBM Pascal implementation occasionally baffled it.

Still it did run Lotus 1-2-3 and Flight Simulator, which often throw other imitation IBMs.

Osborne has also released its Disk-Pac which upgrades the original miserly 100k per drive to a comfortable 400k each.

The system does make the box a little more fragile, with two heads flapping around inside the diskettes, needing to be protected when you travel.

Irritatingly, you can't read data off a new quad density diskette, even off one side of it (it doesn't work in discrete sides) with the original single density or double density machines. IBM you can read, Xerox, you can read. Osborne you can't. Grrr. I haven't met a 'single-sided' diskette that won't format both sides, yet.

Guy Kewney



Did he fall or was he pushed?

Nobody actually *knows* anything about why Jack Tramiel left Commodore.

He had been given a nice new red Transam car by his family, and to their astonishment, instead of setting about a day of meetings with people at the Consumer Electronics Show, he just vanished over the horizon.

Speculation which sounds informed to me suggests that he was pushed.

There was no secret of the hostility between Tramiel and the company chairman, Irving Gould, who had considerably more shares. And Jack Tramiel's management style annoyed a lot of executives.

But losing something as unique as that management style can only mean an improvement in internal comfort. They will come to regret it. It'll all end in tears. You'll see.

Guy Kewney

END

VZ-200 NOW THERE IS A MAGAZINE ESPECIALLY FOR YOU!!! VZ-200

For over four years **MICRO-80** magazine has been helping owners of System 80 and TRS-80 computers to get the most from their computers, publishing literally hundreds of new programs, dozens of articles on programming techniques and how-to-do-it hardware modifications, solving readers' problems, reviewing commercial programs and revealing the inner secrets of their computers.

Now **VZ-200** owners have the opportunity to join this select group. As from Issue 7, Volume 4, **MICRO-80** magazine will also cater for the VZ-200 user. You can look forward to the same high standard of support our other readers enjoy. Our first VZ issue contains two VZ-200 programs plus an article describing how you can unlock three hidden commands inside your machine to speed up your programming. Much more is to follow.

We have saved the best news 'til the end — A 12 ISSUE SUBSCRIPTION TO **MICRO-80** MAGAZINE COSTS YOU ONLY \$36.00 DELIVERED TO YOUR HOME. Don't delay, send a cheque, money order or your **BANKCARD** number and expiry date today to ensure you are a foundation VZ-200 subscriber.

MICRO-80 P.O. BOX 213 GOODWOOD, SOUTH AUSTRALIA 5034
MICRO-80 PTY LTD 433 MORPHETT ST ADELAIDE (08)211 7244

Macintosh

Perhaps it's too early to speculate but many people see the Apple Macintosh as the machine that will succeed in drawing users away from the IBM 'safety net'. Our West Coast contributors, Robin Webster and Leslie Miner, put this compact but powerful computer through its paces while closely comparing it to its big sister, the sophisticated Lisa.

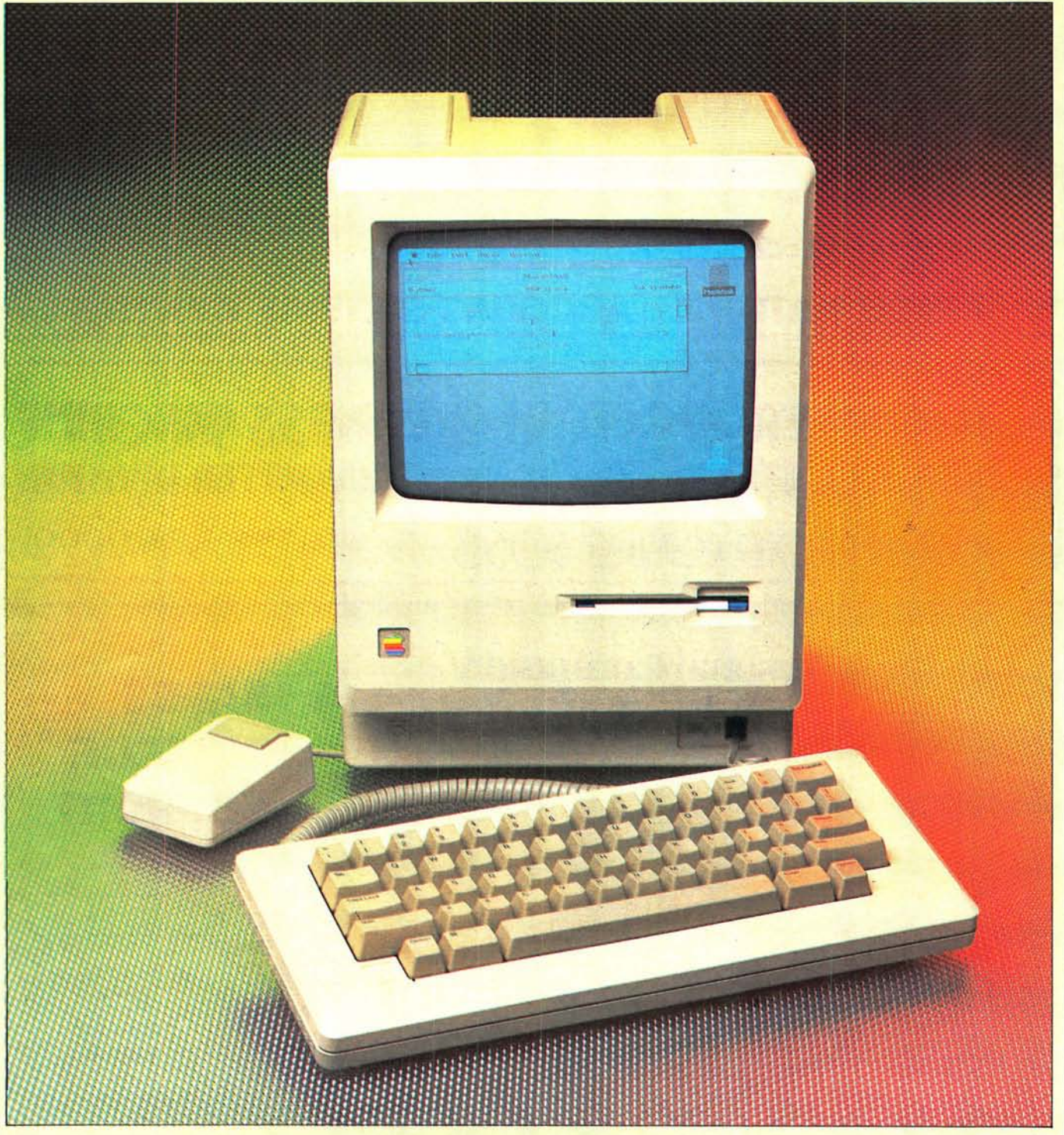

BENCHTEST

Many years ago, a group of researchers at the Xerox Palo Alto Research Centre (Xerox PARC) developed the concept of a small notebook-sized computer capable of showing high resolution graphics on its small flat-screen display. This futuristic machine was named Dynabook.

Today, Xerox is no closer to developing the Dynabook. Instead, Apple Computer has taken the first few steps towards making that particular vision a reality.

With the development of its Lisa office computer system (see Benchtest, APC, August, 1983), Apple drew upon and enhanced much of the work already carried out by Xerox workers.

Indeed, Apple's new computer, the Macintosh, makes comparisons with the original idea interesting.

The machine is compact, but powerful, and modelled on the Lisa concept — it's described as being part of the Lisa family, or as using Lisa 32-bit technology. Its major features are a transportable system unit including high resolution black and white display, one microfloppy disk drive, 128k of main memory and a mouse.

In contrast to early rumours about the Macintosh, it's *not* a watered-down version of the Lisa. It *does* feature a high resolution black and white display that can show visual representations of files (known as icons); it *does* feature a mouse; and it *does* offer many of the software possibilities of the Lisa.

Probably the biggest surprise is that the Macintosh is totally incompatible with the IBM Personal Computer; moreover, it doesn't even run stripped down, revised or enhanced versions of Microsoft's MS-DOS operating system. The surprise comes to many who see Apple's whole future on the brink, due to IBM's inroads into Apple's market share. Instead, the Macintosh uses its own proprietary operating system called the Finder which operates in much the same way as the Lisa' Desktop Manager.

Another surprise is Apple's decision to standardise on the 3.5in microfloppy disk for the Macintosh. A basic Macintosh comes with one built-in microfloppy drive capable of storing up to 400k, although another external drive can be added for around \$600.

In the United States, the suspense over the Macintosh's appearance and what it would be able to do almost paralleled the fuss made over the IBM PC Junior. There is a significant difference,

however. For most people, the PC Junior signals IBM's journey down into the depths of the home computer market (or at least the non-professional computer market). For others, the Macintosh signals Apple's carefully planned attempt to provide computer users with a viable alternative to the MS-DOS software/IBM hardware duo, *and* to remain a billion dollar computer company. Although Apple denies it, some observers are saying, 'The Mac had better be good, or else the company may not survive . . .'

Since it's intended to be an educational as well as a professional machine, US universities were among the first organisations to see prototypes of the Macintosh. Some have already

announced their intention to buy hundreds of them.

On the professional side, Apple says there are about 80 major software developers working on products for the Macintosh. These include standard MS-DOS or CP/M type software packages (which are being outwardly redesigned to make use of the Macintosh's icon-driven and mouse-controlled interface), and new products that will make the fullest use of the Macintosh's facilities.

Hardware

According to one Apple researcher: 'The Apple II was designed in a garage to be built in a garage, whereas the Macintosh was designed to be built by robots.'



9in high resolution black and white display

BENCHTEST

Apple has therefore built an entirely automated factory in Fremont, California, to meet expected demand.

Rather than follow the conventional design of separate system unit, display and keyboard, the Macintosh has been designed more as an all-in-one product.

The one-piece, injection-moulded, plastic casing houses the 9in black and white display, the single microfloppy disk drive (developed by Sony), the main motherboard and the video circuitry. The only separate part is the keyboard. The Macintosh measures 13.5in high x 9.7in wide x 10.9in deep.

At the top rear of the beige casing there is a recessed area that allows the Macintosh to be picked up easily — not unlike the grip on a telephone. While the machine is fairly light — it weighs in at around 9kg including the mouse and the keyboard — it cannot really be described as portable. That compromise description 'transportable' fits much better. Rather than make the Macintosh a clip-together type of system where the keyboard fits over the display and the casing has a handle on it (like the Compaq or Kaypro computers), Apple has designed a special padded carrying case complete with straps.

Since Apple intends the Macintosh to become a truly international computer, it has made sure that there's no writing, in any language, on the plastic casing

(other than the signatures of the main designers which are moulded on the inside back of the case).

Along the bottom edge of the casing are five built-in ports that allow the user to connect up various peripherals.

Like the user-interface, the Macintosh uses icons above each interface port to describe their purpose.

Going from the rear left to rear right, there is the mouse connection, the external disk drive connector, a serial output port for connecting a modem, another serial port for connecting a printer, and a four-channel sound output connector (the Macintosh does have its own internal speaker, but the additional outlet could be useful for stereo output or if access to a high quality speaker system is available).

At the back of the Macintosh, there is an on-off switch set just above the mains power inlet and, above that, a battery storage area used to provide power to the built-in system clock.

A practical design feature of the Macintosh is a security bracket slot on the back which is used, with an optional security kit, to secure the lightweight Macintosh to a desk.

Like its big sister, the Lisa, the Macintosh uses passive cooling. Vents at the bottom of the casing allow air to enter the machine's circuitry, where it's heated. This warm air then escapes from further vents placed at the top of the cas-

ing, on either side of the carrying handle.

When we viewed the system for the first time at Apple's headquarters in Cupertino, California, Steve Jobs, founder and head of the company, said that the Macintosh would be 'the fastest and most powerful computer ever placed in the hands of a large number of people'. Such a statement can, and will, be argued. But what is it about the Macintosh that prompted Jobs to make the claim in the first place?

The Macintosh is based on a Motorola 68000 microprocessor (referred to as a 32-bit chip although it handles data in 32-bit chunks internally and 16-bit chunks along the input-output channels) operating at 8MHz. This is very fast for such a low-cost machine.

In comparison, the original Lisa system uses the same 68000 chip running at about 4MHz and the so-called 16-bit IBM Personal Computer uses an Intel 8088 (16-bit internal and 8-bit I/O transfers) running at 4.77MHz.

The Macintosh's faster processor speed is noticeable when intensive work with the various graphics options is in progress.

The 68000 chip sits on a single large board at the bottom of the machine's casing. The five built-in ports extend out of the motherboard's back edge. As well as the 68000 chip, the board holds a 64k ROM, the graphics processor, 128k of RAM memory and a number of other important devices. Semiconductor products have been obtained from manufacturers such as Zilog, Hitachi, Texas Instruments, and Motorola.

The major criticism of the Macintosh is that it has only 128k of memory. Many people will feel that if Apple is trying to make it the new alternative to the IBM Personal Computer and its growing army of lookalikes, then it would probably have made a lot more sense to enter the market with a 256k Macintosh, instead of a 128k machine. After all, even the IBM PC Junior can be stretched to include 128k of main memory.

When asked about the decision to go ahead with a 128k Macintosh design, Steve Jobs responded: 'When the Apple II was launched it was supplied with 2k of ROM. The IBM Personal Computer has about 6k of ROM. The Macintosh has been supplied with 64k of code locked into ROM that is the most tightly written code I've ever seen. The 64k



The keyboard is well laid-out and very user-friendly

PRINTER & TERMINAL CABLES

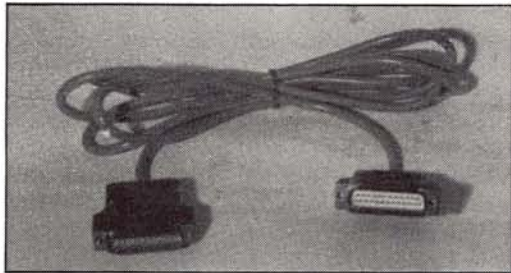

ALL SERIAL CABLES **\$18.00**
 ALL PARALLEL CABLES **\$32.00**

SUIT

APPLE, OSBORNE, IBM, COMMODORE, AMUST etc
 When Ordering Specify Computer Type

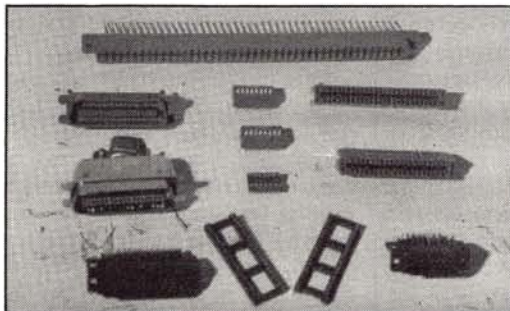

CONNECTORS SOCKETS ETC

QUALITY PRODUCTS. WRITE FOR FULL LIST

25 way D Male	\$2.60	36 Way Cent Ribbon	\$11.00
25 Way D Fmale	\$3.20	36 Way Cent Solder	\$12.00
25 Way D Cover	\$2.50	26 Way Edge Conn	\$6.50
25 Way D Ribbon	\$9.00	40 Way Edge Conn	\$8.00



PRINTERS

120 CPS Superior Quality DOT MATRIX
 Same Price as 80 CPS **\$495** Inc Tax & Cable

Add 10% for P&P with a minimum charge of \$2.50. For printer allow \$8. no P&P
 Please supply the following items:

.....	Computer Model
.....
.....	Printer Model
.....
.....	Bankcard Number
.....

ARBITER ELECTRONICS
 Shop 82, Stafford City,
 Stafford Road, Brisbane 4053
 Telephone: 352 5792

Computer Galerie

North Sydney

for Computer of the year



If you are a professional or own a business, you will get enormous productivity gains by using our profitable advice. Computer Galerie is Australia's senior authorised micro computer dealer. Here are some of our range of PROFESSIONAL SOFTWARE.

ACCOUNTING
 FBS STOCK CONTROL
 The Akkountant.

Bookkeeping programs for NEC with 1000 expense categories only \$195

WORD PROCESSING

NEW Spellbinder word processor with mail merge and data sorting, \$695

KNOWLEDGEMAN!

The database/spreadsheet and statistical language taking the US by storm. Our version fully installed is \$695. Less than DBase II by \$300

SUPER SPECIAL
 MAGNUM 128k PORTABLE
 ONLY \$2795 with 12" screen
 SAVE \$350

NEC



Professionals get enormous productivity gains by using our advice.

Phone for an appointment
 with David Diprose
 66 Walker St., NORTH SYDNEY
 (02) 929 5497



B E N C H M A R K T E S T

ROM contains a lot more than just the complete Macintosh operating system.'

The 64k ROM includes the operating system along with the necessary file system and device drivers (printers, displays, and so on) for handling I/O operations, and it includes a number of other software 'layers'.

One layer concerns itself with all the 'management' tasks such as memory management, mouse operating management and keyboard management.

A second software layer contains about 35k of code which is referred to as Quickdraw. Quickdraw is exactly the same program as is used on the Lisa system to handle graphics-oriented operations. When LisaDraw is used to create a box or circle, it is in fact Quickdraw in control, not the application program.

The application program — LisaDraw in our example — can be thought of as just one way that Quickdraw can present its abilities to the user.

Traditional programming techniques involve the development of fairly large programs built to do some specific task. There's a lot of custom built code to do the specified task, but occasionally these programs will have to reach into onboard ROM memory to access some even more specific routine. Using the hand-held calculator analogy, the functions square root, %, and logarithm are examples.

With the Lisa and Macintosh, Apple designers have reversed the situation. Instead of having programs call ROM-based or library routines, they have made the library routines so sophisticated that they are actually in charge most of the time — it's only when the user tries to do a task, which the applications code is far better suited to handle, that control is handed over to the application.

A third layer is the Toolbox code (the Lisa has the Toolkit). The Toolbox code

is a key feature on the Macintosh since it is the means by which independent software developers will learn about the inner operations of the machine. The Toolbox facilitates access to and use of the operating environment 'primitives' including menu management, window management, type font management, window contents scrolling and the generation of dialogue and alert boxes (system and error messages to you).

In total, the 64k Macintosh supports over 500 system calls — and although we're not quite at the join-the-dots stage, the new software development approach practiced by Apple is getting close. The 128k main memory is reserved totally for application programs loaded from the microfloppy disk, and the user data (word processing documents, pictures, graphs) entered at the keyboard.

At right-angles to the motherboard, and running up the left side of the machine is the video and power supply board.

Drawing power from the board is the Macintosh's 9in, bit-mapped screen displaying 512 × 342 pixels. This compares with the 12in, 720×364 pixel display on the Lisa. The screen provides a stable image, with no perceptible signs of flicker or waves, and it's possible to work for hours with the machine without the discomfort of eyestrain.

The Macintosh employs both a brightness adjustment control, located just under the screen at the front of the casing, and a Preference type option called the Control Panel.

Via the Control Panel the user can adjust various settings, such as audio signal levels, the speed at which keys will repeat when held down (presently

indicated by tortoise and hare icons), and the background pattern of the desktop, which is normally a grey half-tone. The system clock can also be set on the Control Panel.

Two more differences in design between the Macintosh and the Lisa are the mouse and the separate keypad. The mouse has been redesigned with a larger button. The keypad, which is an integral part of the Lisa keyboard, comes as an optional extra that daisy-chains onto the Macintosh keyboard.

Software

The Macintosh's proprietary operating system is called the Finder.

The Finder operates in much the same way as the Lisa's Desktop Manager. It maintains the various system icons on the display and reacts to the ways in which the user attempts to manipulate them. If the user selects an icon by pointing at it with the mouse-controlled cursor, and then goes to the menu bar at the top of the screen to 'open' the icon, the Finder must ensure that the operation is successful. If the user selects the litter bin icon and then attempts to put that icon into a word processing document, the Finder must be able to inform the user that such an operation is not allowed by gently returning the litter bin to its original position.

Since the operating system is ROM-resident, the Macintosh comes alive as soon as it's switched on. It checks the microfloppy drive to see if a disk is present and, if it detects one, starts to load its directory into memory.

As soon as the directory information is loaded, a diskette icon appears on the screen. If the disk has already been named, this will appear immediately below the icon. If not, the mouse is used to place the cursor over the disk's default name to select the current text by clicking it once. As a result the new name is typed.

To see the contents of a disk, select the icon by clicking on it once and then use the 'Open' option located in the File pull-down menu. Alternatively, click on the disk icon twice in succession.

The Macintosh does not come with all the desktop icons (Desk Accessories) that the Lisa places at the user's disposal once it's been fully powered up. In some cases, the required icon

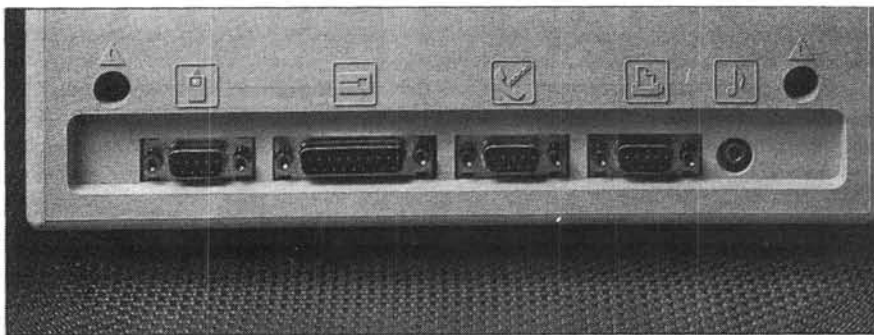

Above the interface ports are icons describing their respective functions

BENCHTEST

from the menu bar options at the top of the display has to be invoked. Those available include the calculator (a much simpler version than the Lisa offering), the litter bin (for deleting unwanted files) and a version of the Lisa clipboard (used as an intermediate storage area for data during cut-and-paste operations) called the scrapbook.

It should be borne in mind that while the Macintosh is a very fast 32-bit machine, it only provides single-tasking facilities, but this is not a handicap because the one megabit per second serial ports are interrupt-driven. The user can, for example, run the disk drive, move the mouse, generate music, type a key on the keyboard, and read the serial ports all at the same time. Also, because it's single-tasking, the multiple window capability is less comprehensive than the Lisa's.

MacWrite

MacWrite is similar to LisaWrite, but its designers have decided to implement some of the standard word processing facilities in a new way.

When MacWrite is loaded the user is presented with a blank screen, and a topline menu bar which offers the options: **File, Edit, Search, Format, Fonts, Style**. To the left of the word File is a small Apple logo, which is itself a menu option that will produce a pull-down menu with various sub-options if selected.

The user can start writing straight away, since the MacWrite system is provided with the usual margin defaults. For customising, the margin ruler has to be displayed via the Format menu option. The ruler appears at the top of the current document and the margin/tab settings are clearly marked by small triangular icons. These can be picked up with the cursor and moved around at will.

Below the actual ruler markings and margin setting icons, there are two groups of rectangular boxes.

One group, composed of three rectangles and set to the left of the screen, is used to set the document line spacing. Three options — single, double, and triple — are provided.

The second group of four rectangles is set to the right of the screen and is used to select the current document's layout, or justification. The four options are: text left justified, text centred, text

right justified, and text justified. Again, the user merely clicks on the required icon to obtain the desired format.

On the pre-production Macintosh which we Benchtested, the MacWrite program came with a wide selection of typestyles.

MacWrite acts as a fairly sophisticated word processing program in many aspects, but it's not the smartest in terms of main memory (RAM) usage. As data is typed in, MacWrite stores it in memory until there's no space left. This limits document size to about six pages. To write larger documents, close the first document and then open up a second document. The text must be printed out sequentially — juggling with page formatting in each document.

MacWrite is not the only word processing program being developed for the Macintosh — independent software developers such as Microsoft are working on their own versions. Virtually all these word processing programs will be more sophisticated than MacWrite in at least one important aspect: they will employ memory swapping, or paging techniques. This will enable users to create documents that are limited in size purely by the capacity of the microfloppy disk drive (400k minus directories, damage repair code, and other system necessities).

MacPaint

MacPaint is not a structure editor — it's a bit editor; the position of any single pixel on the screen can be altered even if it's a part of some larger picture. There are a number of ways to do this.

If a square is drawn and filled with a grey pattern, part of that square can be sliced off by selecting the dotted outline rectangular icon from MacPaint's palette. This icon allows the user to grab all or part of a picture by encompassing it with a shimmering dotted outline box. The outline can be expanded by pulling its lower right corner down and to the right, and shrunk by pushing the lower right corner up and to the left.

Once part of a picture has been 'grabbed', the shimmering outline solidifies and the selected area can be picked up and moved to any other location on the display. Any of the normal cut-and-paste type of menu options can also be applied.

The MacPainter can choose from many on-screen options, and even some of these can be adapted if necessary. Down the left of the screen there is the main palette which contains 20 permanently displayed options. In addition to the dotted outline box, there is the lasso icon which is a very powerful addition to a graphics system. Since we are dealing with a bit editor, and not a structure editor, situations will often arise where the user wants to grab a piece of text, or an irregularly shaped object without grabbing any of the surrounding empty space. The lasso icon allows this.

Unlike the Lisa, and unlike the Lisa-Draw application, MacPaint does not provide a multi-windowing capability and there are no window border controls for scrolling information. Work with one MacPaint document must be completed before another can be opened. Instead of border controls MacPaint's designers have included an icon of a hand in the palette. This can be used to push the screen in any of the four directions.

Text can be included and there are a number of options for drawing geometric shapes. Such shapes can be automatically filled with a pattern if so desired.

The really impressive palette options that show the capabilities of a bit-oriented graphics editor are the airbrush, pencil, paintbrush and eraser.



The mouse is a versatile little beast

Now a high volume, daisy wheel printer for under \$1400.

An integral part of today's word processing system.

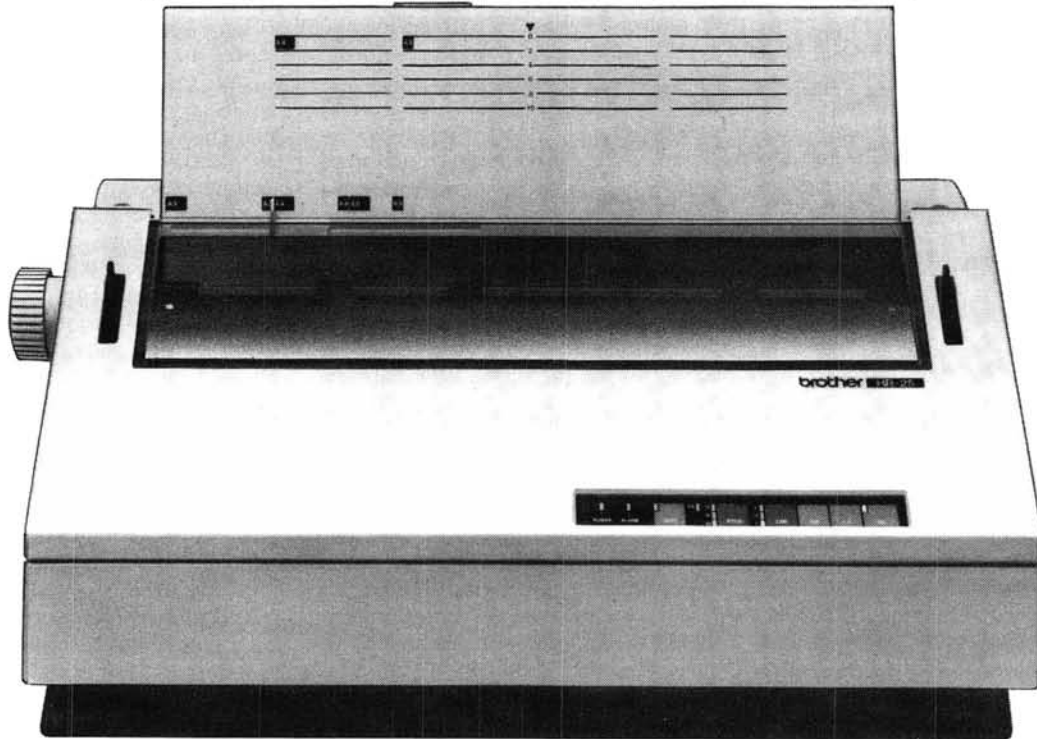

The Brother HR-25

We know you won't match its price/performance anywhere and it will be a valuable asset to any modern, expanding office.

If your work load demands high volume with daisy wheel quality, the Brother HR-25 delivers the services of a professional printer at an amateur price.

The full width carriage handles everything including computer printouts and the tractor feeder and cut sheet feeder further expand the output of the HR-25.

The 5K buffer memory allows you to print a large amount of data, including identical copies, freeing your computer for other uses.

The bi-directional printout operates at a swift 23cps, so productivity is even further enhanced. \$1345* (rec. retail. Price includes sales tax).

The Brother HR-15

Designed specifically for the smaller office with lower volume and with a price tag to match.

The HR-15 is truly versatile with its interchangeable letter quality daisy wheel, optional electronic keyboard, and a 3K buffer memory which makes it unique in its class. \$849* (rec. retail. Price includes sales tax).

Ask your nearest Brother stockist to demonstrate all the skills of these quite exceptional machines.

*With Centronics interface. Also available in RS 232C at a slightly higher price. W.A. prices slightly higher.

brother®

The Affordable Electronic Printers.

Brother Industries Ltd., Nagoya, Japan.

Brother Industries (Aust) Pty. Ltd. 49 Herbert Street, Artarmon, NSW Phone: (02) 439 7344
Victoria: (03) 873 3655 Queensland: (07) 52 5257 South Australia: (08) 42 6373 West Australia: (09) 478 1955

Brother's Optional Extras



Electronic keyboard (HR-15 only)

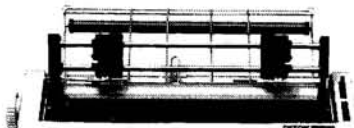

Tractor Feeder

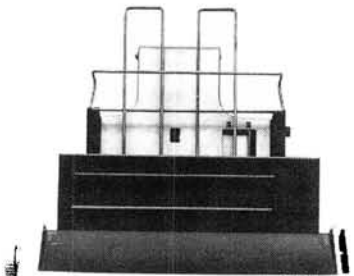

Auto Cut-Sheet Feeder

CSO 4277

BENCHTEST

Across the bottom of the MacPaint screen there is a selection of 38 patterns.

The first time the airbrush is used, only a few pixels will be deposited. As a specific area is focused on, the chosen pattern will become more and more prominent.

The pencil icon is used to draw freehand lines, of various thicknesses, and when this is selected the cursor takes on the form of a tiny pencil. It makes signatures and creative artwork quite easy to do, although practice is needed to obtain good results.

The paintbrush is used to paint freehand lines on the screen, and a wide variety of paintbrush textures as well as widths and shapes are available.

A powerful adjunct to the paintbrush is the mirror option. It's obtained from what is currently being called the Goodies menu bar option at the top of the screen. Mirror allows MacPaint to be set up so that it will automatically produce mirror-image copies of anything drawn. With one setting, if an object is drawn in the bottom left hand corner, MacPaint will produce mirror images in the other three corners. With another setting, if a name is written at the top of the screen, MacPaint will produce an inverted image below it.

Fat Bits is another possible selection from the Goodies menu option. At certain points in the use of MacPaint, a method of removing or adding just a few bits here and there from a picture is needed. For example, a line may look a little jagged where it meets another line, and this can be corrected by removing a few pixels from one of the lines. Fat Bits allows you to zoom in on an area of your picture and to add or take away parts of a drawing a pixel at a time. The pencil can be selected to add pixels (click once in a clear area) or remove pixels (click once on an unwanted pixel). The effect of this work is shown in a small box inset at the top left of the picture.

The eraser icon is used to delete any part of a picture. When this is selected, the cursor changes into a small box which can be used to rub away large areas or, if you have a steady hand, a few rogue pixels which are spoiling the picture. At times, the eraser box was too large to fit into all the nooks and crannies of a drawing. It would be preferable to have the option of choos-

Technical specifications

Processor	68000 Motorola running at 4MHz
Memory	128k RAM; 64k ROM
Disk drives	3.5in Sony microfloppy
Measurements	13.5in high x 9.7in wide x 10.9in deep
Operating System	Finder (ROM-based)
Interfaces	Mouse connection, external disk drive connector, serial output port modem, 4-channel sound output connector
Screen	B/w 9in bit-mapped, 512 x 342 pixels
Applications	MacWrite, MacPaint, MacTerminal, MacDraw, MacProject, Macintosh Basic, Macintosh Logo, Macintosh Pascal, Macintosh Assembler/Debugger, Toolbox, Quickdraw
Weight	Approx 9kg

ing the size and shape of the eraser, in the same way that the size and shape of the paintbrush can be selected.

By itself, MacPaint is a powerful graphics program; the fact that Apple will soon be releasing MacDraw, which will presumably be a structure-oriented graphics package, makes the Macintosh very inviting indeed.

The initial software packages to be available for the Macintosh from Apple this year include MacWrite, MacPaint, MacPascal, MacBasic, MacLogo, MacAssembler/Debugger, MacTerminal (communications), MacProject (project evaluation) and MacDraw.

Independent software

According to Apple, over 100 independent software developers are working on products for the Macintosh. Included among these are Microsoft, which looks as if it will redesign many of its current packages for use on the Macintosh, and Lotus Development Corporation, which intends to produce a Macintosh version of the 1-2-3 package. Allied with the interest from add-on hardware vendors this suggests that users will soon have a wide range of software and/or hardware options from which to choose.

Lisa 2

During the time we were shown the Macintosh, the development team stressed that the machine was part of the 32-bit family of Lisa technology.

This seemed a little confusing at first. Since the machine uses 400k microfloppy drives and the Lisa uses unique 5¼in, double access slot diskettes that can store over 800k, it seems Apple is heading for all sorts of problems

with compatibility between the two machines.

The company has dealt with the problem in an interesting manner by launching three new versions of the Lisa: the Lisa 2, the Lisa 2/5 and the Lisa 2/10. All these machines come with 512k main memory as standard, instead of the usual 1 Mbyte of RAM.

Apple has overcome the compatibility problem by making the Lisa and the Macintosh employ the same disk media (the 3.5in microfloppy) and has begun to develop the necessary software to allow the Lisa to emulate the Macintosh. This is a compatibility strategy that few people expected.

It raises the possibilities of software organisations buying Lisa systems to develop code quickly for the Macintosh, and of office workers in general using Macintosh systems at home and then taking disks to use with their Lisa systems in the office.

This seems more feasible than the Personal Computer/PC Junior exchange which people were expecting from IBM.

AppleBus & AppleLine

The recently developed AppleNet, which was built around an Ethernet-type communication protocol, has been supplanted by the simpler AppleBus and AppleLine products. Having decided that there was too much chaos in the local area network (LAN) arena, Apple felt the best approach was to leave such heady stuff to companies like IBM — which appears to have opted for a token ring networking system — and to make sure that Apple products could connect up to whatever IBM brings to the LAN market-place.

apricot

The 4th generation personal computer

A computer that, for the first time, works with you rather than just for you. Hardware and Software co-ordinating perfectly, Apricot arrives complete and ready to work.

The MicroScreen™ on the keyboard, unique to Apricot, performs a variety of practical functions—as a calculator, calendar, time display, and as a window on the screen. Most significantly the MicroScreen™ prompts and assists the user by presenting simple options whilst running applications.

As you'd expect with a 4th generation system, Apricot offers true 16-bit processing multi-processor architecture and 256K RAM as standard.

With 16-bit business software and compatibility with the best selling Sirius 1 and IBM PC, Apricot already has the largest available software library.



Incorporating the very latest advances in computer technology, Apricot uses 3½" pocket-size diskettes. Secure and compact, yet offering increased storage capacity.





Apricot includes over \$1,000 of software—SuperCalc spreadsheet, business and communications software—to ensure that your system is immediately effective.

And because executives are not office bound, Apricot offers portability, a further feature aimed at improving efficiency.

Powerful sleek and sophisticated—and all at an amazing 4th generation price.

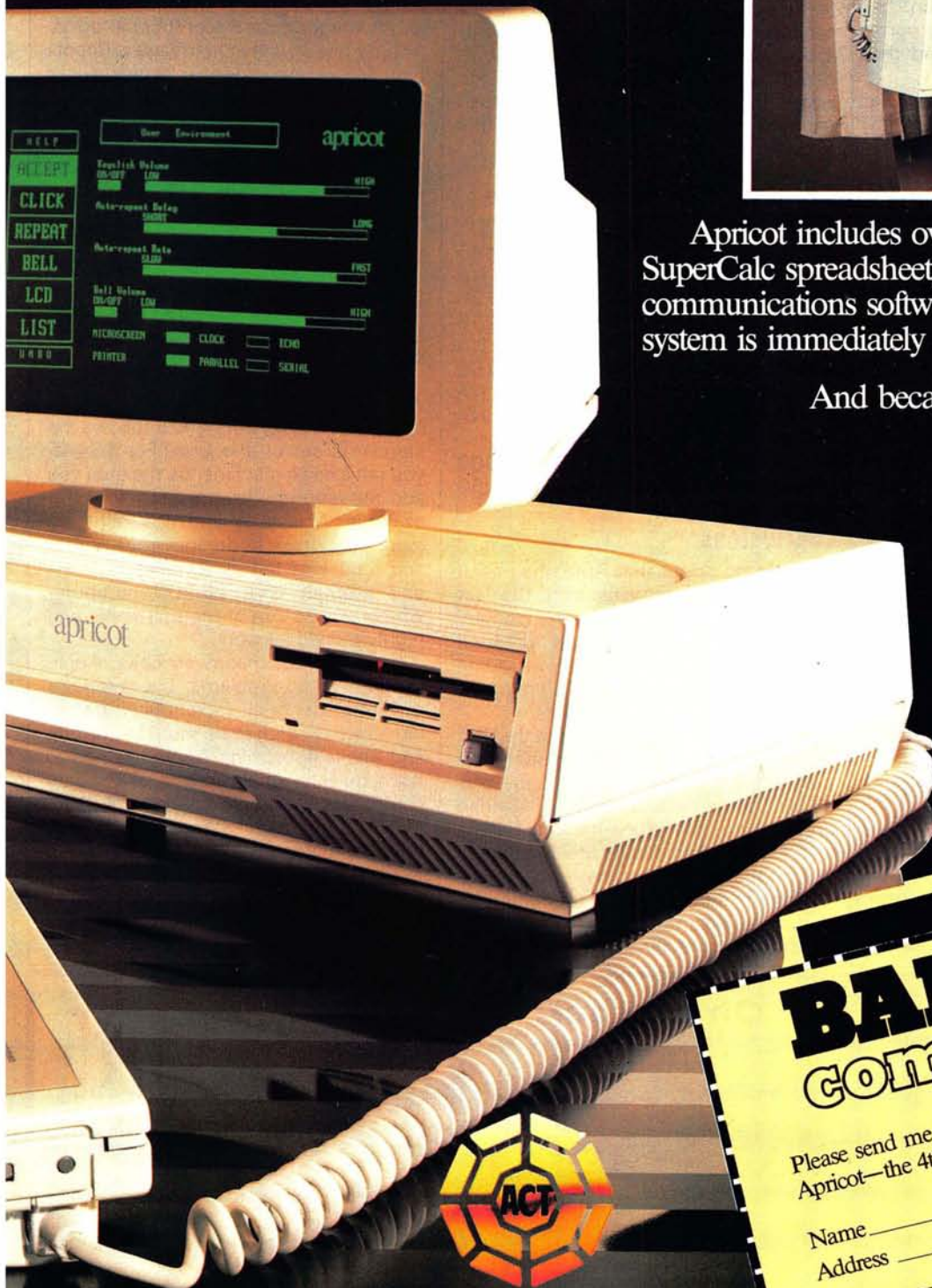

BARSON computers

Please send me the latest information on Apricot—the 4th generation personal computer.

Name _____
Address _____

Post Code _____
Phone Number _____



BARSON COMPUTERS
335 Johnston St. Abbotsford, Vic 3067
or call 03-419 3033

BENCHTEST

Physically, AppleBus is nothing more complicated than a single cable containing shielded twisted pair wires. With the right connectors, this cable can be attached to either/both of the serial ports at the back of the Macintosh and the Lisa.

In the simplest configuration, a Macintosh will communicate with another Macintosh or a Lisa. In more complex, corporate environments, AppleBus provides the ability to link up to 16 devices that are up to 1000 feet apart. Apple is making the full specifications and protocols of AppleBus available to all interested communication software developers and equipment vendors.

AppleLine, on the other hand, is Apple's main way of entering the enemy camp.

It's hardware add-on with software that will allow Apple computers to hook up to an IBM cluster controller (not unlike the Irma board that turns IBM PC into a 3270-type terminal). With the equipment installed, and the right data transfer software in use, the Macintosh or Lisa will then look to the IBM controller as if it were an IBM 3278 terminal. In fact, it will be possible to connect up the Apple IIe and the Apple III in a similar manner in the not too distant future.

AppleBus costs will depend on the type of configuration installed, but the cable will be sold on a 'so much per metre' basis. The AppleLine product should retail for about US\$1300.

Documentation

No documentation was available for review but an Apple spokesperson described the Macintosh user manual as only having about 100 pages. It comes

with a tutorial disk called Guided Tour (similar to Lisa Guide) and a cassette. Standard textual run-down of the application features, a 'cookbook', or task oriented section and a tutorial. Apple's documentation has always been good when compared with the average burnt offerings and it looks as though the Macintosh technical writers will carry on in this tradition.

Prices

Macintosh	\$	
(including sales tax)		3445
External disk drive	NA	
Separate keyboard	195	
Mac carrying case	155	
Security kit	NA	
Imagewriter printer	750	
Modem 300	NA	
Model 1200	NA	
AppleLine network product		Under 1800
Diskettes (each)		7.60

Conclusions

There is no doubt that Apple has been suffering growing pains over the last year or so. IBM has been the primary adversary with its office oriented Personal Computers, and now the home oriented PC Junior. The PC Junior will obviously affect Apple IIe sales.

Steve Jobs frankly admits that the IBM PC was a milestone in the personal computer industry because it gave the personal computer a much needed credibility in the office market. But he also frankly states that the Macintosh will be the next milestone.

There is only one standard configuration of the Macintosh. The main customisation of the machine will occur through

software. As add-on devices are built — there is already talk about a hard disk option under development at Tecmar — access to the machine will be through its two 1 megabit per second serial ports. Apple's notion is that hardware is important, but you can no longer force the user to be a system builder. Apple still sees itself as the company that makes computers for individuals rather than the anonymous office worker, and makes this appeal in its US marketing approach.

Based on our brief experience with the Macintosh, the only danger seems to be that some of its graphics interface features border on being too whimsical. How many times can you look at a whimsical icon before you tire of it?

The Macintosh is a powerful machine with a growing number of powerful applications programs, and it follows the standards set by the Lisa. For \$3445 you get a basic machine; by the time you add on various software programs (for example, MacWrite and MacPaint, an extra disk drive, an Imagewriter printer and a pack of ten blank diskettes), the end product is a \$5,200 computer which can do run-of-the-mill tasks and highly individual work.

If hard work meant success, Apple would have no problems; but in today's market-place, other factors like marketing strategy seem to be more important, and this is something Apple has had to learn quickly. Apple is one of the few companies that could take on the IBM/MS-DOS *de facto* standard with any chance of winning, and the Mac is a terrific weapon with which to enter battle.

No Benchmarks are given as Basic has not yet been implemented on the Macintosh.

The exciting Brother HR-15 letter quality daisy-wheel printer has optional low profile plug-in keyboard, Tractor Feeder for Data Processing, and Auto Cut Sheet Feeder for Word Processing.

Amongst the wide selection of typewriters is the brother CE-60 electronic typewriter with interface for all Computers.

CAULFIELD BUSINESS COMPUTERS

(A division of Caulfield Typewriters)
874 Glenhenty Road, Caulfield South 3162
Telephone: (03) 528 4555

Oh brother!

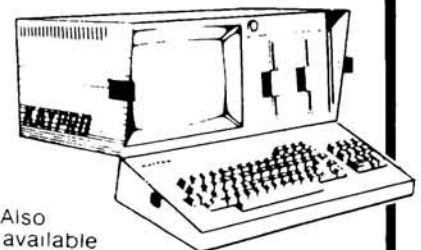
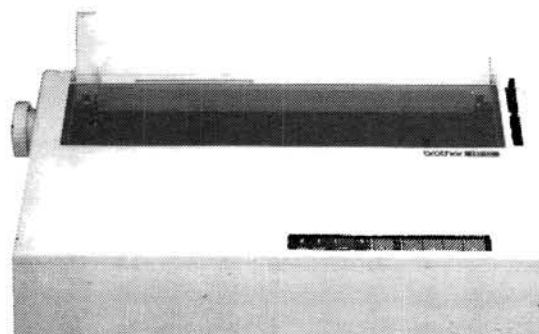

Also available

KAYPRO II KAYPRO IV & 10

COLUMBIA 16 bit IBM PC compatible

When it comes to superior performance, we study our lines very carefully.

The STAR GEMINI-10X is America's best selling printer. Forget all those XYZ-80 clones with expensive running costs (cartridge ribbons). If you want a more versatile, faster and longer lasting printer normally you would have to pay substantially more. Now for less than the price of an XYZ-80 clone and for a limited period you can purchase a quality, high speed, long lasting printer with low (conv. spool ribbon) running costs.



120CPS for only **\$499** incl. tax.
Serial Interface card only \$50

Only Computer Technics can offer you this fantastic value on the outstanding Gemini 10X printer. An exclusive double length six month warranty PLUS a free cable thrown in to get you up and running straight away. No more interfacing/cable headaches with this special offer.

We also currently have these printers on special!

SALE

★★★★★★★★★ **STAR** ★★★★★★★★★

Gemini 15X . . . 15" carriage, 120 CPS\$750
Delta 10 . . . 10" RS232-4K Buffer, 160 CPS\$699
Delta 15 . . . 15" RS232-4K Buffer, 160 CPS\$1199

All above include cables.

Complete Commodore 64 and Apple printer systems only \$549

Guaranteed backup service by Case Communication & Computer Tech.

Apple is the registered trademark of Apple Corp.

Commodore is the registered trademark of Commodore Computers.

**WE CAN ALSO SUPPLY HIGH SPEED AND WIDER
CARRIAGE PRINTERS AT VERY COMPETITIVE PRICES.
PLEASE RING FOR DETAILS.**

computer technics

123 Clarence St,
Sydney 2001



LOOK AT THESE FEATURES:

Sprocket, Friction and Single Sheet Feeds; 120cps Bidirectional Logic Seeking; 80, 96, 136 char/line; 9 dot head for true descenders; Block and Bit addressable Graphics; Underlining, Compressed, Expanded, Italic, Super and Subscript, Normal/Special Character sets: Special Correspondence Quality Printing Mode; Epson Codes are Compatible with this Printer; Original & Two Copies on Sprocket; Buffer and Many More.

EXCLUSIVE

2X
**Extended
Warranty**
Doubles the Warranty Period

EXCLUSIVE

FREE!
CABLES

★ **CENTRONICS** ★

★ **RS232** ★

Please Specify



Apple Interface card
only \$50 extra.

Commodore OWNERS

NO, WE HAVEN'T FORGOTTEN YOU!!!

We have made available at low cost (when purchased with Printer) these Vicsprint Intelligent Interfaces and Cable assemblies.

- ★ Converts unintelligible codes to Printer prints (blu), (cirh) etc.
- ★ CBM to ASCII conversion.
- ★ Upper and lower case ★ Italic and Auto line feed.
- ★ Straightthrough mode
- ★ 1 year guarantee.



**FOR COURTEOUS ADVICE
OR ORDERING PHONE:**

(02) 29-7244
(02) 29-3857

**ORDERS TO
G.P.O. BOX 4936
SYDNEY 2001**

ANNOUNCING THE MICRO ELECTRONICS

Come and see our modern
Apple compatibles at the
Australia



EME MODEL III

\$899
(inc tax)

Features

- ★ 6502 and Z80 Dual Processors
- ★ 64K RAM
- ★ Upper and lower case
- ★ Extendable keyboard
- ★ Built-in cooling fan
- ★ Single or twin Teac slimline disk drives can be installed

- ★ The 10 function keys each have 48 characters of built-in memory
- ★ 188 function keys

The latest ABC Green Screen swivel based monitors at

\$220 (inc tax)

AS PICTURED ABOVE



EASTERN MICRO

92-94 BANK STREET, (C)
SOUTH MELBOURNE, VICTORIA 3205 Tele

OPENING OF EASTERN COMPUTER DEPARTMENT

Lowroom and large range of
most competitive prices
nation-wide

BMC BX-80

BMC BX-80
Dot Matrix Printer
OPENING SPECIAL

\$299 (ex tax)
\$349 (inc tax)
With 90 Day
Full Warranty

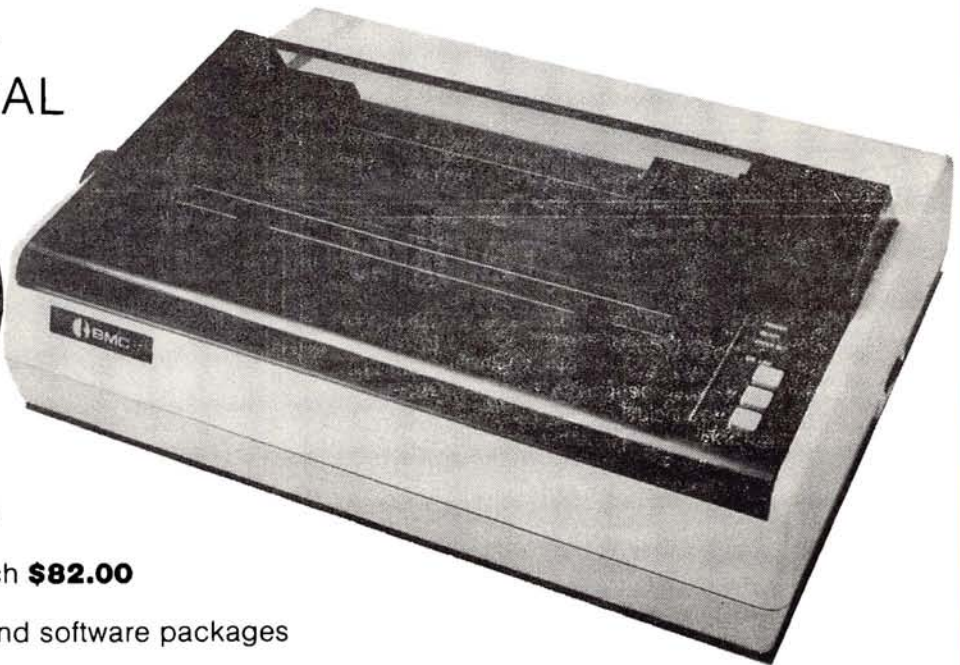

Disk controller card **\$54.00**
Printer cards with cable **\$69.00**
PAL colour card **\$66.00**
80 column card with 40-80 switch **\$82.00**
Joysticks **\$25.00**
and a large variety of manuals and software packages

TEAC SLIM LINE DISK DRIVES

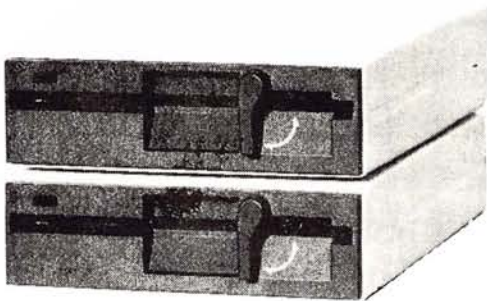

\$319
(inc tax)

ELECTRONICS

1 Bank Street and Kingsway)

Phone: (03) 699 3088 Telex: AA 38432 ATT EME



EASTERN MICRO ELECTRONICS

92-94 Bank St., 5th Melbourne, 3205

Please find enclosed cheque
for the amount of \$

For the following.....

.....
Please send me more
information

Name

Address

Suburb.....

State

OVER 152 PAGES FULL OF SOFTWARE - HARDWARE - PUBLICATIONS AND TECH TIPS FOR THE COMMODORE 64 and VIC-20

Games: New and old on disk, cassette and cartridge. Arcade, graphic adventures the whole gambit.

Tech Tips: Tips on programming and other aspects of computing. From local and overseas experts.

THE
VIC
CENTRE

\$3.50

Books: Books on Robotics, Adventures, Self Tuition, BASIC, Machine Language, Games, Programming etc. etc.

Special!

AMATEUR RADIO SECTION
Connect your computer to the airwaves - articles on RTTY and AMTOR - other details.

MENU

UTILITIES
GRAPHICS
SOUND
HOME/OFFICE
LANGUAGES

Business: Ledgers, spreadsheets, wordprocessors, development systems, statistics, cash books etc. etc.

Hardware: Touch pads, printers, interfaces, modems, joysticks, expansion cartridges etc. etc.

GAMES, EDUCATIONAL, BUSINESS, HOME AND UTILITY SOFTWARE, BOOKS AND PERIPHERALS FOR THE COMMODORE VIC-20 AND 64 COMPUTERS

SUMMER 1984

Magazines: From home and abroad including electronic magazine and Commodore specials.

Education: One of the most comprehensive listings available for the Commodore.

Adventures: Travel to outerspace, the tombs of Egypt. Fight the dragons and cast the spells. Be a Dictator or an oil barron. A whole universe is here.

Most comprehensive listing of software/hardware, publications for Commodore 64 and VIC-20 in the country.

it's all there and more.
available through your COMMODORE DEALER or
THE VIC CENTRE

a division of CW ELECTRONICS

416 Logan Road, Stones Corner, Brisbane Phone (07) 397 0888

P.O. Box 416, Sunnybank, Qld. 4109

Unique Unix

Bell Lab's Unix has spawned many imitators since its introduction in the 60s as an operating system for mainframes. With its successful implementation on business micros, Peter Bright analyses the reasons for its popularity.

A year or so ago, the business operating system market was plain and simple. There was one major operating system — CP/M, with a few other machine specific operating systems like Apple, Commodore and Tandy. They all supported just one user. Today the scene is a great deal more complicated; hardware has become more powerful and there are many more operating systems trying to become Number One in their particular area.

One of the more recent developments has been the release of the so called 'super micros'. These have moved into the multi-user areas that were previously the province of minis costing tens of thousands of dollars. These new super micros need an operating system and a high percentage of them are offering Unix as their choice.

APC has looked at Unix before (back in July, 1981 — Vol. 2, No. 1), but events have moved on since then and I feel it's time we took another look to see where Unix stands today.

History

Unix has been around for many years — it was first written in 1969 to run on a DEC PDP-7 mini at Bell Labs (the research arm of AT&T — see Fig 1) by Ken Thompson and Dennis Ritchie. It was designed as a multi-user interactive programming environment for the staff at Bell. Unix roots go back to an early mainframe operating system known as Multics, which has since developed from Version 5 through to System 5. The first generally available portable version was Version 7, which was developed into System 3 and then into the latest implementation which is known as System 5.

Bell Labs hasn't been the only company developing Unix — many other companies have released their own versions. Some of these are based on

the original Bell Labs source code and are therefore largely compatible with Bell Unix. Others have been written from scratch by borrowing ideas from Unix. One of the most popular Unix lookalikes is Xenix from Microsoft. This is based on Version 7 of Bell Unix but as the two companies develop their own products, so the differences increase.

Popularity

Why has Unix become so popular? The answer lies in a number of areas. One of the major factors is that Unix used to be given away to universities and higher educational establishments, so many graduate programmers came out of university with an in-depth knowledge of Unix. When they got into industry they went for Unix in a big way.

Another big advantage of Unix is that it's portable. It can be moved from machine to machine relatively easily because much of Unix is written in a high level language known as 'C'. As long as the machine that's intended to run Unix has a good C compiler it will only be necessary to rewrite some of the more machine-dependent parts of Unix, which usually only involves a small percentage of the total code. Unix has moved very well to the new super micros that use the Motorola MC68000 processor, with companies such as Root Computers specialising in porting Unix onto the new machines. This portability is something very few other mini/mainframe operating systems are capable of achieving.

Shell

Unix has been described in many different ways. My favourite description is to look on it as an egg — the hardware is the yolk, the Unix kernel is the white and the eggshell is the shell. In other words, when you sit down at your terminal and think you're talking to

Unix, you are actually talking to the shell.

It's perfectly possible to write your own shell and run that instead of the standard shell — one of the best examples is the Fortune 32:16 which has substituted a menu system for the standard shell. This may be no bad thing — the standard shell is not known for its friendliness.

Shell programming

One very powerful feature of the Unix shell is that it's possible to build programs using just the shell commands. This is known as 'shell programming'. Using the shell you can test the status of a file, assign string variables, test variables, and so on. The shell also supports certain control structures:

```
IF condition THEN action ELSE action FI
CASE word IN
    pattern) command-list;;
```

```
...
ESAC
FOR variable-name IN list DO action
    DONE
```

```
WHILE condition DO action DONE
```

Using these structures, it's possible to solve some quite complex problems without ever having to resort to a high level language. Once the program is completed it can be saved to a disk file, and when it's called it will be executed in exactly the same way as a standard Unix command.

Pipes and filters

Unix has a wide range of software tools that read their standard input and write to their standard output (standard input is where the utility expects to see its input coming from disk, keyboard, and so on). These tools are known as filters — they take their input, modify it in some way and then output the results; for example, sorting a data file and then

processing the sorted file. On most other operating systems the data is read into the sort, written to a temporary file and then read into the program.

Unix differs from other operating systems in that you can avoid using temporary files by using 'pipes' (see Fig 2). A pipe will direct the standard output of one filter straight into the standard input of another without bothering with intermediate files.

Directories

The file system in Unix is based on a tree structure (see Fig 3). This means that any directory can have a number of sub directories which in turn can have sub directories of their own, and so on. In other words, you start with the main directory (known as the root) and then go on down through the system.

Each Unix system has a root containing standard sub directories called BIN, DEV, LIB, USR and ETC. BIN contains binary files used by the system, DEV refers to I/O devices such as printers and VDUs, LIB contains the library files, USR contains user directories and files, and ETC holds the rest of the system files.

When a user logs onto the system he will be taken to his 'home' directory, which is usually a sub directory of USR. New directories can be created using the MKDIR command followed by the new directory name. The CD command is used to move to a new directory.

In order to find a file or a directory, it's necessary to specify what is known as the pathname. This can take one of two forms — either as an absolute address from the root or as a relative address from the current directory. For example, if I had a program called MYPROG in directory PJB, the absolute address would look something like /USR/PJB/MYPROG. Here, the first '/' refers to the root directory while the other obliques are used as separators. This highlights one of the problems of using Unix — the same character can have a totally different meaning in different contexts. The oblique is one of the worst offenders in this respect — accidental use of this character can have some very strange effects.

It's also possible to specify a pathname in relation to the current directory by the use of '..'. This is used to represent the next highest level directory. So, for example, if I were in my directory called PJB, '..' would take me back to the USR directory.

Files

Unix supports one file structure and doesn't mind what kind of data is entered into it, so text, binary files and command files can all be put in the same filetype. Filenames can be 1 to 14 characters long

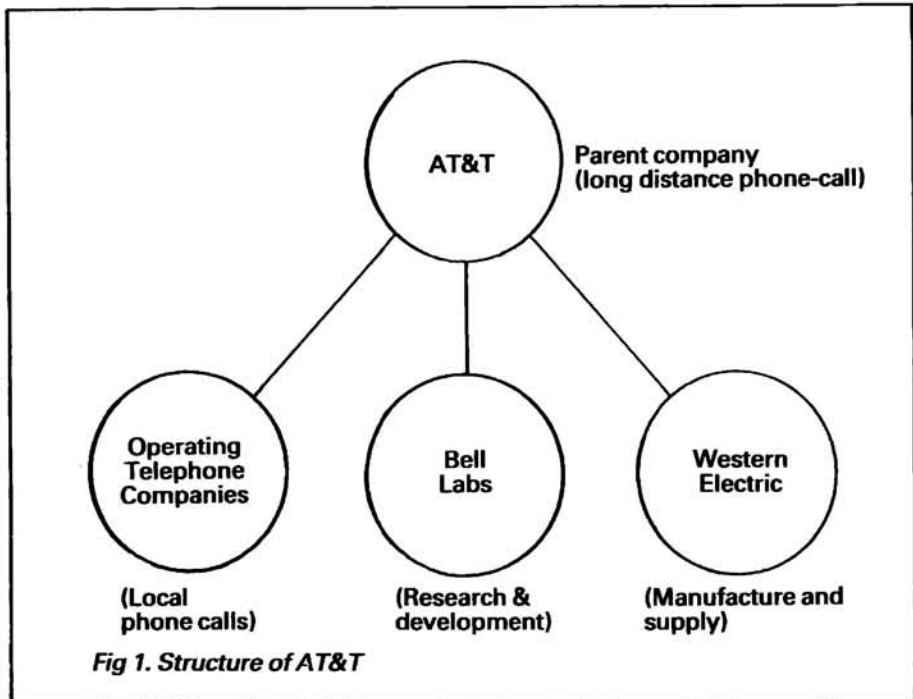

Fig 1. Structure of AT&T

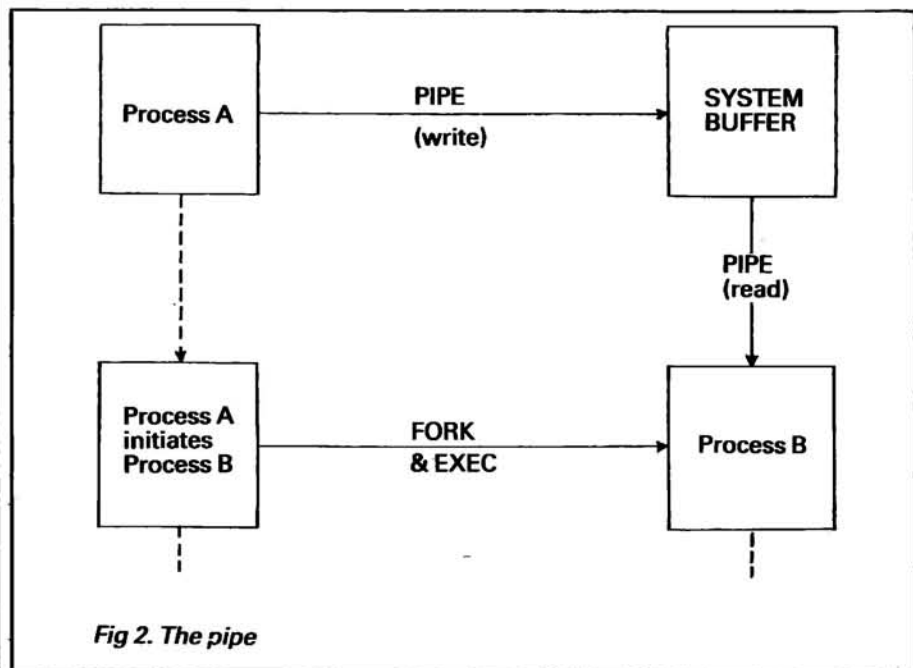

Fig 2. The pipe

but '/' cannot be used. Unix supports a powerful range of wildcards to help you find your file easily. Anyone who has used CP/M, MS-DOS *et al* will be familiar with '?' as a single character match and '*' as a string match, but Unix also supports a range match '['. An example of this would be LS PETE[1-10]. This would list files PETE1, PETE2, ..., PETE10.

An interesting point about Unix is that it can write the file to disk, tape, printer or VDU, making it easy to redirect files without having to worry if the device will understand. All the device drivers are held in the 'DEV' directory.

It's also very easy to redirect the stan-

dard input and output of a process. This is achieved by the use of the '<' and '>' commands. For example, the ECHO command will usually print its argument on the screen (therefore the standard output is VDU). However, if you were to type ECHO AUSTRALIAN PERSONAL COMPUTER > FRED it would write AUSTRALIAN PERSONAL COMPUTER to a disk file called FRED instead of printing it on the screen.

Security

Any multi-user operating system must have some method of protecting files and directories so that they can only be

PUBLISHERS BLUNDER!

UNI CO-OP QUE BOOK SALE



Best selling books now available at **COST PRICE!**

A warehouse contract problem enables us to make a never-to-be repeated offer, **only while stocks last!** Top quality Que Corp. books at **cost price or less!** The warehouse mistake is **your benefit.** Grab these best selling high quality books while their prices are low. (N.B. Further stocks will be back to normal prices!)

AT LEAST 33% OFF

*Bestselling titles ** Very limited stock available

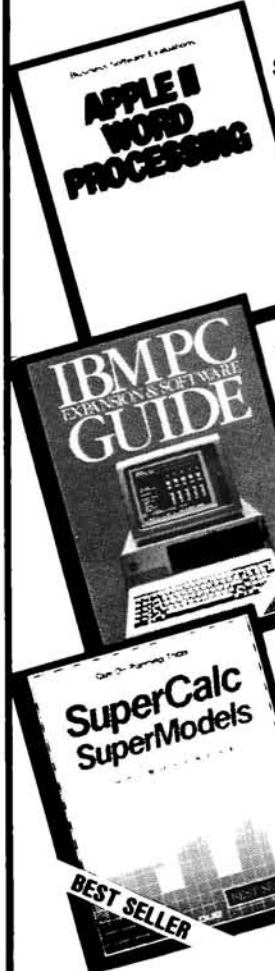

S.10
Specific, highly useful information so you can determine **exactly** what word processing you should buy for your Apple **before** you invest valuable money and time.
Was \$39.95 Now
\$14.99

***S.14**
The definitive source of information about software, hardware, supplies, and services for the IBM PC and XT. Thousands of product descriptions and multiple indexes make this book an excellent investment for all PC users.
Was \$33.95 Now
\$19.99

***S.18**
Recommended by many professionals, this book is an excellent resource for any SuperCalc user.
Was \$25.95 Now
\$19.99

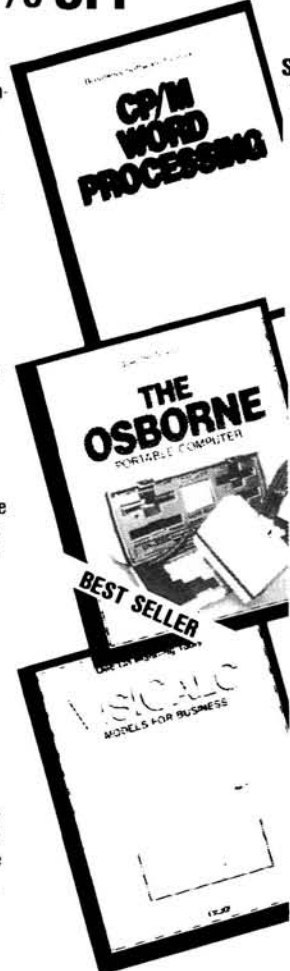

S.12
The intelligent buying guide to word processing with comprehensive, easily readable evaluations of word processor, spelling corrector, and document-maintenance software packages.
Was \$33.50 Now
\$13.50

***S.15**
A comprehensive description of the entire Osborne portable computer system. If you want to get the most out of your Osborne computer, this is the book for you.
Was \$25.95 Now
\$15.99

S.19
Clear step by step instructions show you how to get maximum benefits from your electronic spreadsheets.
Was \$25.95 Now
\$19.99

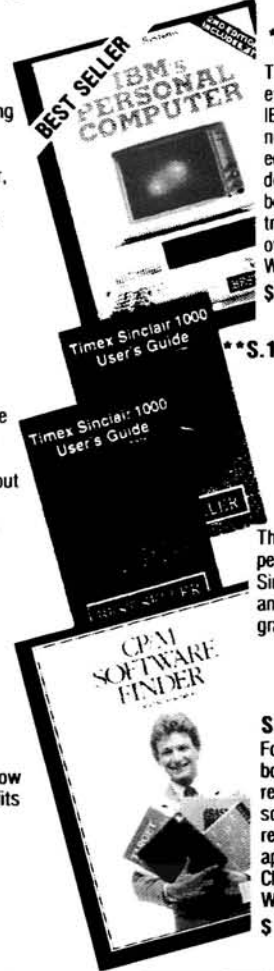

***S.13**
The most popular book ever written about the IBM Personal Computer now in its second edition. Many IBM dealers recommend this book as the perfect introduction for new owners of the computer.
Was \$29.95 Now
\$19.99

****S.16 Vol. 1**
Was \$19.95 Now
\$12.99
****S.17 Vol. 2**
Was \$25.95 Now
\$15.99

These books give you the perfect introduction to Sinclair ZX81 computers and computer programming.

S.20
For CP/M users, this book is a superb resource. Descriptions of software include system requirements and the appropriate version of CP/M for each program.
Was \$25.95 Now
\$19.99

*INSPECT THESE AT YOUR CLOSEST BRANCH

- TECHNICAL BRANCH 831 GEORGE STREET, SYDNEY PHONE: 211 0561 • 80 BAY STREET, BROADWAY, N.S.W. PHONE: 212 2211 • NSW INSTITUTE OF TECHNOLOGY • NSW UNIVERSITY • SYDNEY UNIVERSITY • ANU CANBERRA
- WOLLONGONG UNI • CANBERRA CAE. • MACQUARIE UNI. RYDE • ARMIDALE UNI (U.N.E.) • NEWCASTLE TECH.
- NEWCASTLE UNI. • RIVERINA CAE. (Wagga Wagga) • MITCHELL CAE. (Bathurst) • GRIFFITH UNI. (Old.) • GIPPSLAND IAE (Vic.)

AVAILABLE BY MAIL ORDER!

Please send me the following books by return mail

\$

\$

Add postage: \$3.25 N.S.W. \$4.75 elsewhere. \$

Cheque/Postal Order enclosed \$

or Bankcard No.

Send to:

UNI Co-op Mail-Order P.O. Box 54 BROADWAY, NSW. 2007

Place me on your free mailing list for 12 months

NAME

ADDRESS

STATE

P/CODE

SIGNATURE

Expiry

APC 4/84

accessed by authorised personnel. In Unix, the first line of defence is the normal user code and password system. The second line of defence relates to permission for people to access specific files and directories.

Files and directories can be accessed by three groups of people — the owner of the file, the user group he belongs to, and everyone else. Files can be read only, write only, executable or any combination of these three, each group having its own set of permissions. For example, the owner might have read, write and execute permission, the user group could have execute permission only and everyone else could be barred completely.

Access permission can be changed by using the CHMOD command.

Unix also provides for a 'super user' who can access any file in the system whether it's protected or not. Usually this will be allocated to the system manager. The super user is an obvious weakness in the security of a Unix system — Bell Labs has been working on the problem for years but as yet hasn't come up with anything better.

Very large data files can sometimes cause speed problems on Unix systems, because disk space is allocated in an apparently random manner one block at a time, with pointers indicating where the next block is located. The file can

then grow very easily but the problem is that the read/write heads spend most of their time moving to the next block rather than actually reading data.

Office applications

Ever since its early days Unix has been used as an environment for business applications: modern Unix has a number of interesting features designed to aid office automation. Everybody's talking about electronic mail and Unix has its own version known very originally as MAIL. Using this feature, messages can be sent to friends and work mates, and also pick up any messages sent to you. If a message has been sent, the system will inform the user when he logs on by displaying 'You have mail', or something equally short and to the point. The messages can then be saved or deleted, as required.

Unix also has a wide variety of text processing packages — three of the most common are Ed, Troff, and Nroff. Unix can be supplied with many different editors but Ed is the only one shipped with every system. In keeping with everything else about Unix, Ed is not very friendly but it's very powerful. In order to edit a program file it is necessary to type ED followed by the file name. The program loads the file which can then be edited, but Ed is unhelpful: if a mistake is made it will respond with a '?' and wait for the mistake to be corrected. If H is pressed a short error message will be displayed.

One of the main differences between Ed and most other editors is that it makes very little use of line numbers. They are there if they're needed but the approved Ed method is to refer to the area of required text as a pattern and then let Ed wander off to find it. Using the pattern matching ability of Ed it's very easy to perform complex search and replace operations on a file.

Troff and Nroff are both text editors, as opposed to Ed which is designed for editing program files. Troff is designed to output to phototypesetting equipment whereas Nroff is designed for standard output to a printer.

System documentation

To use a Unix command correctly, refer to the user manual which is held on disk. To do this correctly and easily, type MAN followed by the command name. The system should then display a number of pages showing what the command does, what parameters it needs, and so on. The only trouble with the manual is that it keeps faith with everything else about Unix by being hard to understand, but most of the necessary information is

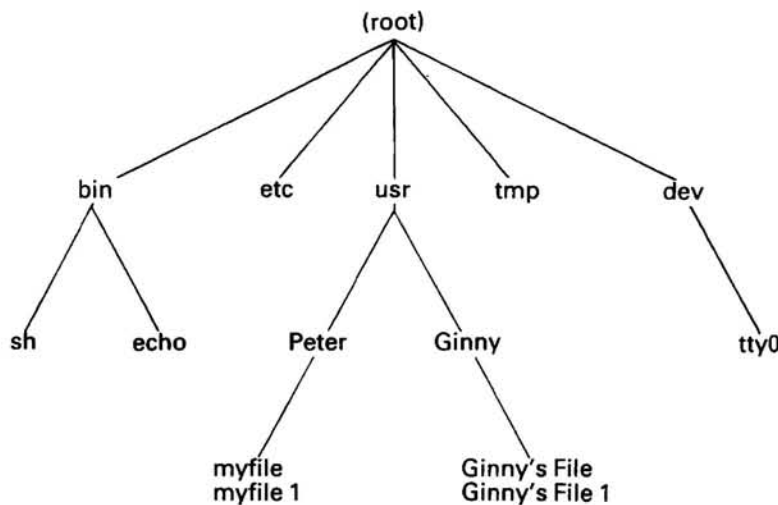

Fig 3. Directory Hierarchy

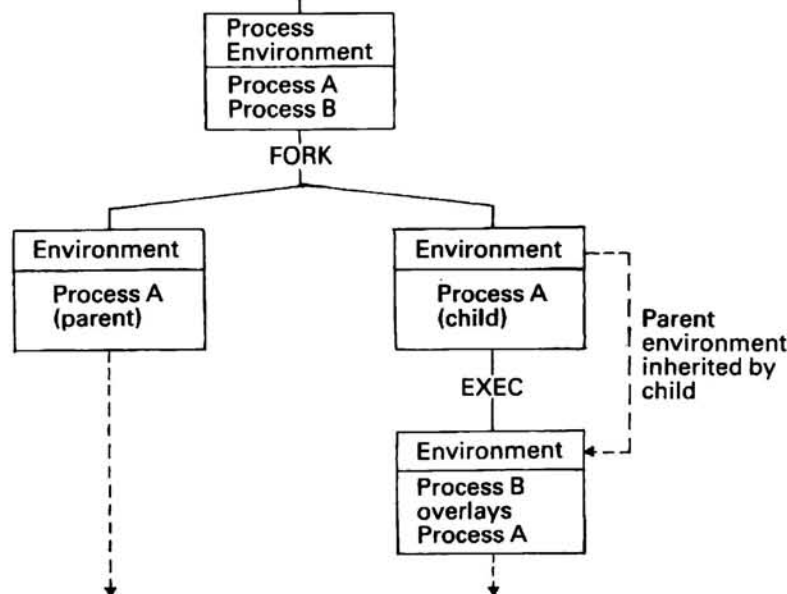

Fig 4. Fork process

OPERATING SYSTEMS

there (including any known bugs).

Unix in context

So where does Unix stand in the micro world? One point to remember is that most other micro operating systems were written for micros, whereas Unix was designed for minis and has now moved onto micros. The majority of today's Motorola 68000 multi-user machines offer Unix, which in turn means there's more of an incentive for multi-user software writers to make their programs run under Unix.

At the moment, Unix doesn't seem to have many large scale competitors in the multi-user market, MP/M, MBOS and Pick being the only main contenders.

As a business operating system Unix is not ideal. It has some very powerful features but is not user-friendly — it's a hacker's paradise. Having said that, a great deal can be done to mitigate its hostility. It's a comparatively straightforward job to modify the shell, and a number of companies offer friendly versions of Unix.

This leads on to what has been one of the major problems facing Unix users —

the lack of support from Bell. Until recently, Bell shipped Unix with virtually no customer support — the reasons for this are embedded in the anti-trust laws of the USA. This has now changed and Bell is taking much more interest in the marketing of Unix. Some will say that the damage has already been done. So many other companies have cashed in by offering their own versions that compatibility problems are bound to set in — unless

Bell can pull the other suppliers back into line.

In the final analysis it's not necessarily the best product that becomes the industry standard — this has more to do with being in the right place at the right time. It's too early to assess properly the effect Unix will have — it's certainly ahead at the moment, but we may still see a late run from Pick or one of the other systems.

COMPUTERS HAVE TO BE TAUGHT WHAT TO DO FIRST! . . .

Learn how to program a computer/Introductory & advanced courses

Courses Include: Introduction to Computers

- Assembly language and machine level programming
 - Graphic and arcade game design
 - Using CP/M operating system
 - Database management using DBase II
- Playing games in basic ● Pascal programming ● Pet projects

This is why you should come to us

SMALL CLASS SIZES, QUALIFIED TEACHERS WHO SPEAK YOUR LANGUAGE!
ON HAND EXPERIENCE, FRIENDLY ATMOSPHERE, DAY OR EVENING COURSES AVAILABLE. PRICES TO SUIT YOUR BUDGET Discount for students & pensioners

***HURRY number of students per class is limited
Ring Janine NOW for further details**

DIRECT DATA 1357 Malvern Rd, Malvern Ph: (03) 20 6949

A.A.012-3



RETAIL PRICE BREAK!

13 REASONS WHY THE **1st MATE™** SHOULD BE YOUR **1st CHOICE:**

- **Reliability** - "Burned In" for 3 full days prior to shipment — Less than .3% failure rate
- **Fully Compatible** with IBM PC's and other Tecmar products
- **64K - 256K Memory** - fully socketed for easy field upgrade
- **Versatile** - Each 64K fully addressable
- **Clock/Calendar** with easily replaceable battery back-up
- **Serial Port** for communications
- **Parallel Port** for printer
- **60% Faster** - SpeedDisk simulates ultra high-speed disk
- **RAMSpooler** - allows printing to become back-ground task — Easy to use - **Choice of 8 memory sizes**
- Accepts exclusive **PAL Option** to restrict certain information on 'need to know basis'
- Full One Year Warranty
- 72 Hour repair turn-around **Guaranteed** - 24 hour average

The **1st MATE**

The Best . . . Take Advantage of the New, Low Prices for **1st MATE**, Tecmar's Most Popular Multifunction PC Expansion Board!

\$560 64K

Don't settle for 2nd best! Get yourself the **1st MATE™**, known for quality, quality, reliability and engineering excellence. So, take advantage of this fantastic price. Call Merton Scott (09) 328 6522 for information and to place your orders. We'll rush your shipment to you! Act Now!

M S **Merton Scott**
Business Machines PTY. LTD.
248 Newcastle Street,
Perth W.A. 6000
Telephone (09) 328 6522
Telex AA93413



MICRO-EDUCATIONAL

AUSTRALIA'S LARGEST DIRECT-MARKETING COMPUTER SUPPLIER

Price Isn't Everything

Yes, it's true we have the **LOWEST PRICES** in Australia on **QUALITY** computer peripherals. It's also true that we have **OVERNIGHT DELIVERY** anywhere in Australia and offer **10 DAY MONEY-BACK** and **6 MONTH FULL SERVICE GUARANTEES**.

But did you also know that:

- ★ We are the largest direct-marketing computer supplier in Australia. Scouts honour.
- ★ We have excellent hardware servicing facilities.
- ★ We only sell **TOP-QUALITY** products.
- ★ You can order by **PHONE** using **BANKCARD** with complete security. Guaranteed.
- ★ You get to speak to people who **KNOW** about **COMPUTERS**. (George or Bernard).
- ★ We treat you like a **FRIEND-OF-THE-FAMILY**.

So next time you can't find a parking spot or the computer store salesman doesn't know what you're talking about (much less what he's talking about) give me a call. You'll find that low prices are only part of the service.

GUARANTEE

- 1 WE SERVICE WHAT WE SELL. WE WILL ONLY SELL QUALITY PRODUCTS FOR WHICH WE HAVE SPARES & DIAGRAMS. WE WILL NOT SELL CHEAP RUBBISH.
- 2 ALL HARDWARE CARRIES A 6 MONTH FULL SERVICE WARRANTY
- 3 ALL HARDWARE CARRIES A 10-DAY MONEY-BACK GUARANTEE IF GOODS ARE UNSATISFACTORY

10 Day Money Back Guarantee.

WINTER CATALOG OUT NOW Order your copy by phone

Hello again,
 As usual we're busting at the seams with new stock.
PRINTERS. Looking for the best price on Australia top selling printer? We have a warehouse full of DT 80 Printers priced at \$295 ex / \$339 inc. (Gong fast). Our last shipment lasted 2 hours. This time we've bought a sea-containerload! **DISKS** DISKS, DISKS. Selling by the truck load! **DISKS** DISKS, DISKS. devanged! Into your processing? The garage is full of top quality British-made **DATALINER 300** electric copyholders. At size A3 \$129. If you buy one of these foot-switch-controlled copyholders (normal retail \$299) you'll be helping give the Mercedes its home back for winter so open your hearts all you altruistic autophiles. Looking for drives? We have top quality Japanese stimulores for Apple II and compatibles. **ATLAS 8** and **SUPER 5** priced so low maybe I shouldn't tell you the price. Boss-1 keyboards, **BML** green screens, **VISION-80** cards! You name it. We've got it.

George

P.S. If you're buying more than one of anything try twisting my arm on price. **WE LOVE Bulk orders!**

PRICE LISTS
GOODS IN STOCK
APRIL 1984
(RING FOR BULK ORDER DISCOUNTS)



"There are days I'd give my right hand to be ambidextrous!"

PRODUCT	Tax	OnTax	Ex	PRODUCT	Tax	OnTax	Ex
DISKETTES				APPLE PERIPHERALS			
Diskettes, Micro-Educational, SS, DD,				Disk drive controller card	\$ 90	\$ 80	
Reinforced hub, plastic library box				RS 232 Serial Interface	\$ 95	\$ 90	
100-99	\$3.20	\$2.80		Automatic Ice parallel I/F and cable	\$110	\$ 99	
100-499	\$2.90	\$2.49		Automatic Ice Direct Connect Apple	\$369	\$319	
500+	\$2.80	\$2.35		Modem			
BULK DISKS (No Boxes)				Automatic Ice RS 232 Direct	\$345	\$299	
10-99	\$3.00	\$2.60		Connect Modem			
100-499	\$2.70	\$2.29		Z80 card	\$ 90	\$ 80	
500+	\$2.60	\$2.15		IEEE-488 Card « cable	\$295	\$265	
Disk boxes, Lockable, hold 100	\$ 35	\$ 35		Epromwriter & Manual	\$110	\$ 99	
PRINTERS				Vision-80 col card for Apple II or	\$199	\$179	
Dot-Matrix printer, Micro-Educational	\$339	\$295		ilo (spec)			
DT80				Vision-80 128K Ramcard	\$395	\$345	
Serial option for DT80	\$ 95	\$ 95		16K ramcard	\$ 90	\$ 80	
DT80 printhead	\$ 65	\$ 55		Music Machine includes speakers	\$145	\$120	
DT80 ribbon	\$ 12	\$ 10		S.A.M. Speech Synthesizer	\$ 65	\$ 65	
C.ITOH 1550 dot-matrix printer	\$985	\$875		Wildcard, Snapshot or Replay, ea:	\$ 90	\$ 80	
CABLES: IBM, OSBORNE, TRS80,	\$ 35	\$ 35		Clockcard	\$125	\$110	
TI 99, BBC, etc				SMC high-resolution Lightpen	\$245	\$200	
DRIVES (Apple compatible)				Power Supply (TA)	\$110	\$ 99	
TEAC Slimline drive	\$339	\$299		Dataliner 300 electric copyholder	\$ 99	\$ 99	
Atlas Slimline Drive	\$339	\$299		Clip-on fan, includes surge	\$ 65	\$ 55	
Chinson Slimline	\$315	\$275		suppression			
ADMATE squareline drive	\$339	\$299		Joystick	\$ 45	\$ 45	
MONITORS				Koala Pad graphics entry tablet inc	\$180	\$160	
BMC Green Screen (Japanese)	\$195	\$170		software			
Yang Jen 12" monitor, amber,	\$195	\$170		Game Port Extender (2 socket)	\$ 35	\$ 35	
18MHz				Game Port Extender (2 socket +5	\$ 50	\$ 50	
Yang Jen Colour Monitor, Composite,	\$495	\$445		Vision80/Zardax mod)			
PAL, RGB, NTSC				RF Modulator	\$ 40	\$ 34	
Kaga Denshi Vision III RGB col mon	\$725	\$625		Apple Mouse Keyboard function	\$ 79	\$ 79	
Kaga Denshi RGB cards for Apple	\$110	\$ 99		extender for II+			
				DT 80 Ribbons	\$ 12	\$ 10	
				Monitor stands, swivel & tilt	\$ 25	\$ 20	



AUSTRALIA'S LARGEST DIRECT-MARKETING COMPUTER SUPPLIER

DISKS

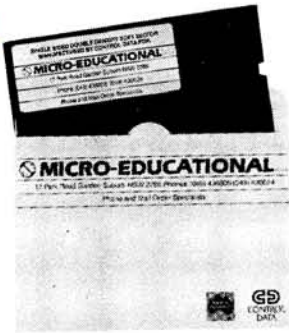

\$29

(EX TAX)

\$32

(INC TAX)

Delivery
1 Box \$2
More than 1 Box \$5
(Courier Del.)

LOCKABLE DISK BOX

\$35

+ \$2 post

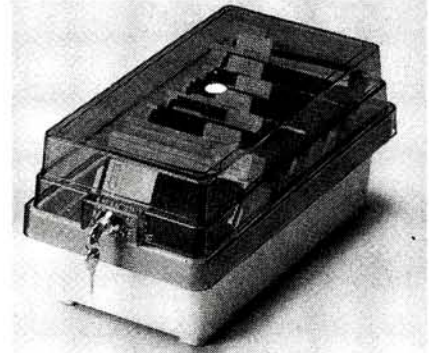

TOP
QUALITY

DATALINER

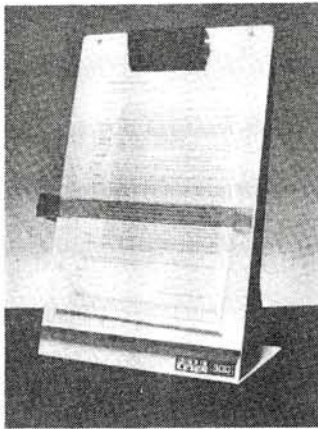

A3 **\$99**
A4 **\$129**
NORMAL
RETAIL
\$249!!

MICRO-EDUCATIONAL DT80 PRINTER

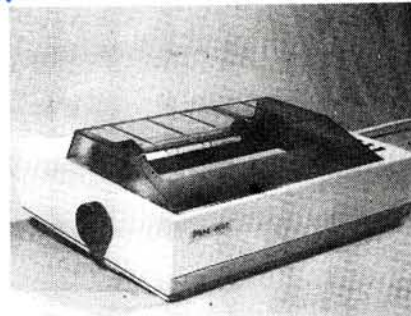

\$295^{ex}
\$339^{inc}

*Reduced
AGAIN!!*

+ \$8 courier
delivery

- ★ Australia's Top-selling Printer
- ★ Epson MX80 Compatible
- ★ GRAB ONE NOW!
- ★ Friction/Tractor
- ★ 80 c.p.s.
- ★ 6 Months Full Warranty

6 Month
Hardware
Warranty

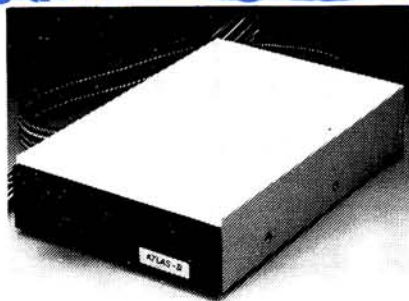

\$275^{ex}
\$315^{inc}

SUPER 5 DRIVE APPLE-COMPATIBLE SLIMLINE

\$45 APPLE II/IIe JOYSTICK



APPLE II/IIe CLIP-ON FAN

Includes Surge Suppression

\$65



HOW TO ORDER

- 1 PICK UP THE PHONE
- 2 DIAL ONE OF OUR NUMBERS
- 3 TELL ME WHAT YOU WANT TO BUY
(YES, I'LL TALK TO YOU ABOUT IT)
- 4 TELL ME YOUR BANKCARD NUMBER
- 5 IT WILL BE DELIVERED TOMORROW MORNING BY
WARDS EXPRESS AIR COURIER (\$5 or \$8 for printers)

It really is that easy. And it's guaranteed by Australia's largest direct-marketing computer supplier. Us. If you prefer, you can send your order by mail or drop in (phone first) to buy direct. Easy.

OFFICE HOURS: 9—8 weekdays/9—2 Saturday

PC
84

The 2nd Australian
Personal
Computer Show
Centrepoint
Sydney
14-17 March 1984

SHOW REVIEW

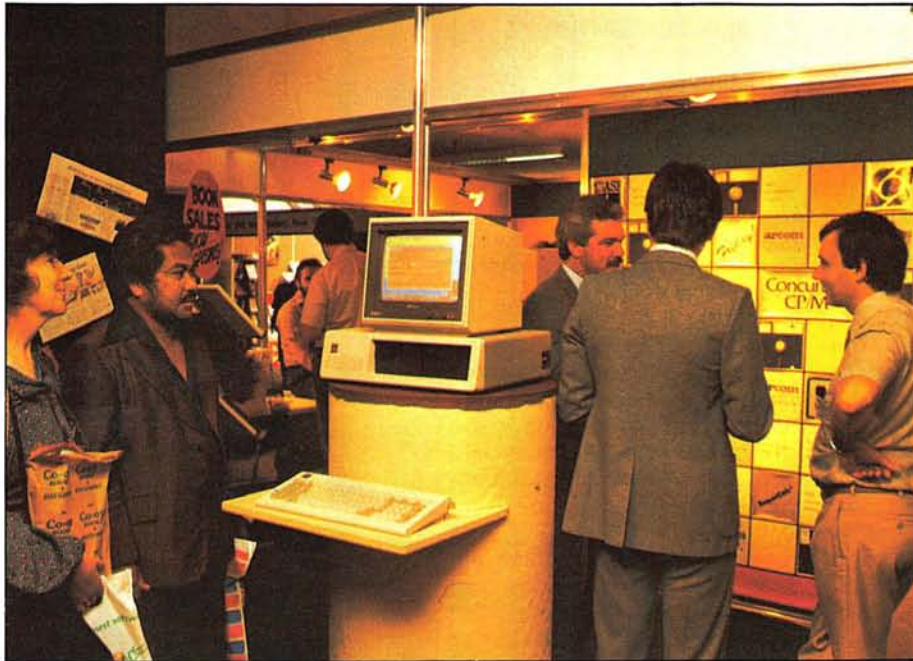

Concurrent CP/M-86 doing its windowing thing on an IBM PC.

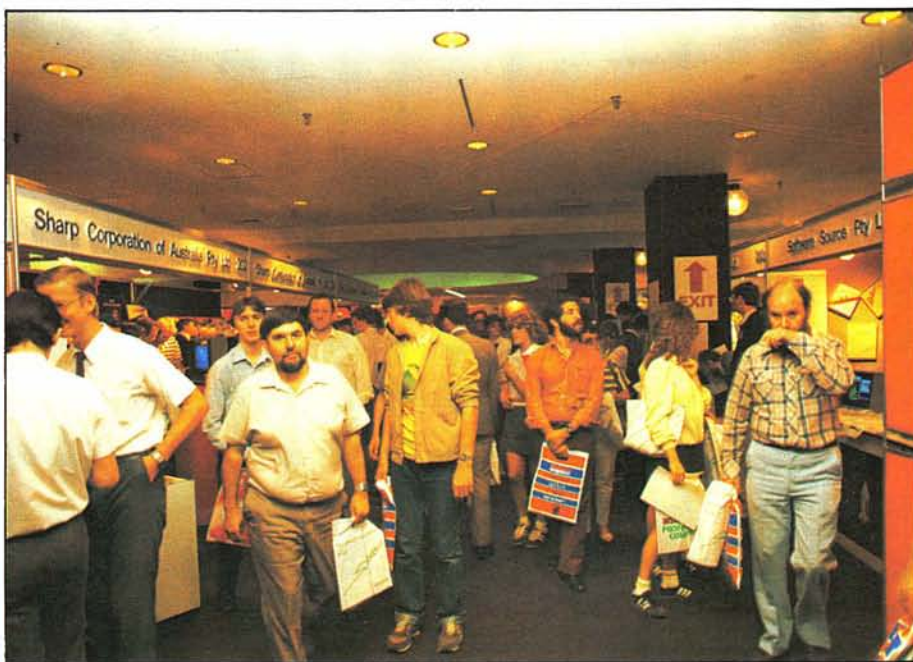

A quieter moment at an otherwise hectic micro show.

How would you judge the success of an exhibition? If that's too hard a question, how would you compare the *Second Australian Personal Computer Show* with last year's event?

The venue was the same, and unfortunately Centrepoint just isn't of the size or standard needed for a major exhibition. One day Sydney will have the pavillion or hall it deserves, but until then we must make do with Centrepoint.

The Show was officially opened by Senator John Button (Commonwealth Minister for Industry and Commerce) at the Wednesday morning breakfast hosted by the organisers. When Senator Button visited the floor of the exhibition he was impressed by what he saw, as well as being surprised by the broad range of personal computers on display.

The good news for visitors was that despite the bigger attendance (approximately 26,000), the queues were shorter due to improved organisation and the fact that the Show ran for four days. Making the opening day a business-only session (no admittance without a business card) was appreciated by exhibitors and visitors alike. Business people could see the Show without having to compete with schoolchildren and casual visitors, while people working on the stands knew they were dealing with serious enquiries.

A feature of the Show that proved especially popular with business visitors was the series of free seminars run by Coopers and Lybrand on behalf of the organisers. Each session was supported by four audio-visual presentations produced specifically for the Show. People attending the seminars were also able to enter their names in a draw for a DEC Rainbow complete with applications software, and several exhibitors were running their own competitions.

Visitors who attended the 1st APC Show may have experienced a sense of *deja vu* as they walked through the entrance as this area was again dominated by the huge Barson Computers stand, and many other exhibitors were also in the same locations as last

year. I heard that the organisers tried to persuade Commodore to take a different stand because of last year's crush around their exhibits, but Commodore stood firm — after all, they *want* lots of people to visit their stand.

Although many exhibitors were at last year's Show, most of them had new products on display. I've already mentioned Barson — they have recently added the Apricot to their range (see *APC* November 1983), and this was one of the micros seen running Concurrent CP/M.

Apple and Tandy both took large stands and both were showing off their new machines. Macintosh attracted many visitors, so those who wanted to get their hands on one had to be patient while they worked their way to the front of the crowd. Tandy was showing their new portable and desktop machines. The Model 4P is a repackaged Model 4 (Z80, CP/M 3, twin disks), while the Model 2000 breaks new ground for Tandy, being an 80186-based system running MS-DOS. Tandy claims significantly higher performance than other MS-DOS systems due to the faster, full 16-bit processor. I didn't have time for a close look at the 2000, but I was told by a visitor that for some reason Tandy decided not to use the normal command shell, so experienced MS-DOS users could be inconvenienced. We'll investigate this aspect when *APC* gets a Model 2000 to Benchtest.

Visitors to the Hewlett Packard stand were able to leave their fingerprints on the much-advertised HP150, while Dick Smith Electronics displayed two new machines. The Challenger was first advertised about six months ago, but the presence of a sample at the Show suggests that deliveries of this low-cost IBM-compatible are about to start. I only spotted one person in fancy dress, and she was on the Dick Smith stand dressed as a black cat. She managed to keep smiling throughout the Show, which was no mean feat as she must have felt pretty silly. When spelled with a capital "C", a Cat is Dick Smith's new Apple-compatible system.

Other new personal computers seen at the Show included the 128k MicroBee and the Sperry PC (which only seemed to attract people wearing business suits).

On the software side, Arcom Pacific was demonstrating the next version of Concurrent CP/M (the one that supports windowing as well as virtual screens) on an IBM PC. Microsoft had a variety of micros running their programs, including some Macintoshes with the Word and Chart programs.

If such serious applications were not of interest to you, several exhibitors gave visitors a chance to play the latest games — Commodore and Futuretronics (Atari) both had rows of machines for this pur-

pose, while many smaller companies were showing extensive ranges.

Several exhibitors were tempting visitors to their stands with special offers. MC-P Applications were selling popular applications programs like Lotus 1-2-3 and dBase II at hundreds of dollars below "list" price (although who pays list price for anything these days), while good deals were available on hardware (like \$64 for a set of 64k RAM chips for the IBM PC) and consumables such as boxes of diskettes.

All levels of the book trade were represented, from publishers down through distributors to retail bookshops. Publishers Prentice-Hall reported many enquiries about books relating to IBM, but so far as sales were concerned the most popular titles were "The C Programming Language" and "Commodore 64".

Computer Club Corner was another feature retained from last year's Show. Representatives from Atari, Apple, TI and Sorcerer users' groups were present to provide information about their clubs and sign up new members. Visitors were also able to purchase a variety of items at special club prices.

The Show attracted considerable attention from the media. Journalists from all the major newspapers and weeklies visited the Show, along with crews from each of Sydney's commercial TV stations plus the ABC. Such coverage reflects the growing public interest in personal computers.

The answer to my opening question must be to seek the opinions of exhibitors and visitors. The exhibitors were happy — comments like "the leads have been fantastic" were typical, and many have again made early bookings

for next year's Show. I only encountered one dissatisfied visitor, an irate woman who couldn't understand why she had to pay to enter the Show. More common reactions were "a great Show — I was really impressed", or simply "it's great".



Dick Smith's pussy.

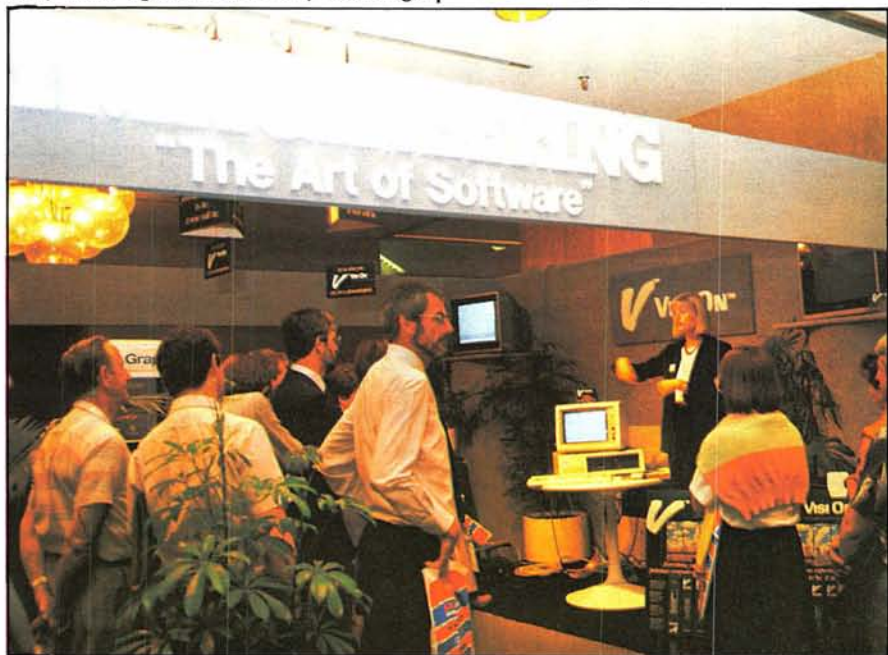

Imagineering conducting mini tutorial sessions on VisiOn.

PC 84 Conference: A delegate's view

Steve Withers debates the merits of the Conference organised by the NSW Branch of the Australian Computer Society.

The Australian Computer Society's 1984 Personal Computer Conference was held in Sydney at the same time as the APC Show.

The Conference organisers attracted speakers from many major US hardware and software companies, but one of the most popular presentations was given by Les Bell (consultant and managing editor of "Your Computer"), probably because he adopted a user's perspective. Too many of the other

speakers were concerned with marketing and thus had little to say to those of us who actually use personal computers on a day-to-day basis, except to drop hints about forthcoming products.

Representatives of the hardware manufacturers were particularly bad in this respect, although Matthew Sanders III of Convergent Technologies gained the respect of delegates when he spoke about the



Windows, windows everywhere . . .



One of the hits of the Show: Apple's Macintosh (seen here on Microsoft's stand).

Workslate. If you imagine an A4-sized computer with a spreadsheet as its primary piece of software, built-in cassette recorder for audio and data, and a speakerphone, then that's the Workslate.

Turning to the software side, Bill Gates was clearly the star of the Conference. His talk on "software futures" gave a clear indication of the nature of the packages that we will be buying in the next few years. While he took the opportunity to tell us how wonderful Microsoft is, his presentation was far more than publicity for the company. On the other hand VisiCorp plugged VisiOn, Digital Research told us about Concurrent CP/M, Ashton-Tate described the momentum behind dBase II (and mentioned that a multi-user version is due for release in May for 3Com Ethernet and Turbodos systems), and while MicroPro started to discuss the need to offer productivity and not simply a product, the talk slid into a description of MicroPro's present and future products. What made matters worse was that most of the speakers were from the marketing side of their companies, and so were generally unable to answer technical questions from the floor or in the informal discussions that took place between sessions.

I can't end this report without mentioning Rodney Zaks. A buzz went round the hall when he described the current claims about "easy to use" software as an example of Madison Avenue at it worst. He made the point that such claims were fine while advertisements were aimed at people within the industry who knew that "easy" meant "Relatively easy", but now the software market has widened to naive users such descriptions are dangerous. People need to develop skills — a spreadsheet or word processor *can't* be easy to use until the user has learned how to operate it and to make good use of it. The acquisition of these skills requires training, and most potential users will demand human instructors. Zaks estimates that as few as 10% will be satisfied by CAI programs. His concern is that this training gap will result in resistance to new software products and therefore some very powerful and potentially useful packages won't be adopted by users.

If I could give one piece of advice to the Conference organisers, it would be that they ensure a high proportion of future speakers are from the development side of their companies. Conferences are meant to be about information, not propaganda aimed at making delegates feel comfortable or uncomfortable with their present suppliers.

Interview: DRI's Steve Maysonave

Many American companies sent senior executives to the Second APC Show and the PC 84 Conference. Digital Research was no exception, so we took the opportunity to talk with Steve Maysonave, DRI's vice president and director of world trade.

He explained that the arrival of PC-DOS and the impact of the IBM PC meant that the company had to reposition itself in the software market. The biggest change is that instead of concentrating on CP/M they now aim to make their products available for all popular environments, including CP/M, PC-DOS and Unix.

Digital Research expect Concurrent CP/M-86 to have a major impact on the market as all corporate users of micros they have contacted want concurrency. The next release for the IBM PC was demonstrated at the Show and should be on sale in June. The most important features are the ability to run PC-DOS programs as well as those intended for CP/M, and the windowing facility which may be used as an alternative to switching from one full-screen display to another.

DRI are also diversifying into consumer products, the first of which is Dr Logo. They plan further products which will tie in with Logo, as well as software that will take advantage of video disks and various types of communications media. One area that the company intends to stay well clear of is the games market.

Maysonave explained that DRI expects Unix to become a significant, but not dominant operating system. This is because they believe that the low end of the market simply won't want it, and there will be an enormous number of computers that won't really have the power necessary to make good use of Unix, in particular those built around the 8086. By 1985 or '86 DRI expect to see machines with Intel 286 and Motorola 68000-family processors becoming popular, and those being used for engineering applications (or by computer science graduates) will be running Unix.

For this reason DRI are now working with AT&T in several Unix-related areas, such as the commercialisation of various extensions to Unix, the development of graphics standards, and in the acquisition and development of scientific and commercial applications. When software is sourced from a third party the documentation and the program itself will be revised to conform to the companies' standards, and then the package will be marketed under the DRI/AT&T logo, with credit

being given to the original developer. According to Maysonave this project has attracted a great deal of interest from software developers.

At the other end of the spectrum, there is still interest in Digital Research's 8-bit products even though there has been a shift in attention to 16-bit systems.

Finally, there is DRI's new networking product. It doesn't have a name at present (they found they could not register the original of Soft/Net), but it

does sound interesting. It provides the top 5 levels of the ISO model — the parts that make a network *really* useful — and is independent of the physical network implementation, so it can be used with Ethernet, Omninet or any other kind of network hardware.

So Microsoft's success in the operating systems market has had a significant effect on Digital Research — the company has reorganised, diversified and developed several new products that probably wouldn't have appeared if it hadn't been for that stimulus. It would be a mistake to write off DRI as a spent force.



Commodore's stand at the top of a set of escalators became a pseudo pinball arcade.



At the entrance to the Show: salesgirl shoving APC down someone's throat.

KOMTEK

This TRS-80 compatible unit can be inexpensively upgraded to include all facilities normally found in more expensive computers. The compatibility with TANDY BASIC LEVEL II means that thousands of programs are available for the KOMTEK micro.

FEATURES

- ★ 16K RAM with real typewriter keyboard.
- ★ Expandable to 48K.
- ★ Home control functions.
- ★ Programmable timer.
- ★ Built in VHF RF modulator.
- ★ Graphics capability
- ★ Built in speaker.
- ★ Auto colour option: For turning your black and white games and graphics into colour automatically.

**ALL THIS IN ONE COMPACT, BUT VERY POWERFUL UNIT
FOR THE SENSATIONAL PRICE OF JUST \$439.00**



PHONE US WITH YOUR BANKCARD ORDER RIGHT NOW!!

SNAPSHOT

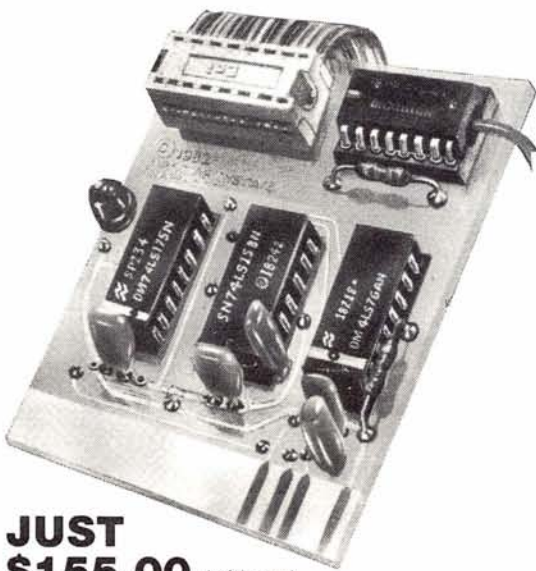

JUST
\$155.00 (with tax)
\$145.00 (excluding tax)

Snapshot is a peripheral card that is **NOW MANUFACTURED IN AUSTRALIA** under licence

- Card is for Apple II or compatible range of machines
- Makes back-up copies of copy protected programs
- Copies programs that baffle other copiers, like Locksmith and Copy II plus, in just 30 seconds
- Analyzes and debugs programs

SNAPSHOT will probably be one of the most useful cards you will ever put into your micro

**SNAPSHOT PRICES ARE NOW BEING SHOT TO
PIECES AT COMPUTER EDGE SO
COME ON IN AND SNAP UP A DEAL**

ALL YOUR COMPUTER NEEDS ARE AVAILABLE FROM:

Computer Edge Pty. Ltd.

229 Chapel Street, Prahran, Vic 3181. Telephone: (03) 529 7622

Hours: 9.00am — 5.30pm Mon.-Thurs. 9.00am — 9.00pm Fri. 9.00am — 12.00 noon Sat.

For toll-free calls . . . orders only, ring **008 33 1131**

Toll-free calls on 008 — numbers allow you to telephone from anywhere in Australia for cost of a local call.



DINERS CLUB

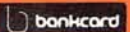



SANYO

MBC 550/555

**Low cost 16-Bit Personal Computer with Colour and Graphic Function
CHEAPER THAN IBM, DICK SMITH, AND ALL THE OTHERS!!**

IBM COMPATIBLE

FEATURES

- 16 Bit Modular Personal Computer system for multi-purpose application
- 8088 CPU with 128KB RAM memory that can be expanded up to 256KB
- MSDOS operating system with optional CP/M-86
- Standard Centronics Parallel printer interface and optional RS232 serial interface
- Dual 160Kb slim-type mini floppy disk drives reading MSDOS standard format diskettes
- Low profile enhanced ergonomic Keyboard with coiled cable for easy use
- Choice of B/W or Colour monitors with 80 char. x 25 line format
- Graphics function with 640 x 200 dots
- Industry standard joy stick port

SPECIFICATIONS

HARDWARE

CPU	8088 (3.6MHZ)
RAM	128KB — 256KB (optional)
	32KB VRAM
ROM	8KB(IPL/CG)
Speaker	Alarm sound can be used
Keyboard	Detachable with coiled cable ASCII type low profile
Floppy Disk Drive	2 x 5¼" 160KB slim line drives dual 320KB (optional)
Display	8 x 8 dot cell with 80 char x 25 lines, 6 x 7 character font. B/W monitor or 8 colour RGB monitor option.
Communications	RS 232C port (optional)
Printer Interface	Std Joy stick facility Centronics Parallel

SOFTWARE

Operating System	MSDOS with CP/M-86 option
Language processor	Basic, Fortran-86, Cobol-86, Pascal MT + 86
Electrical	Local voltage + 10%
Dimensions	Main Unit 360(W) x 110(H) x 365(D)mm, Keyboard 449(W) x 35(H) x 169(D)mm



MBC550 Single Disk Drive	\$1,734.00 incl. tax
MBC555 Dual Disk Drive	\$2,234.00 incl. tax
WORDSTAR, CALCSTAR	\$195.00 incl. tax
MAILMERGE, SPELLSTAR & INFOSTAR	\$295.00 incl. tax

Computer Edge Pty. Ltd.

229 Chapel Street, Prahran, Vic 3181. Telephone: (03) 529 7622

Hours: 9.00am — 5.30pm Mon.-Thurs. 9.00am — 9.00pm Fri. 9.00am — 12.00 noon Sat.

For toll-free calls . . . orders only, ring **008 33 1131**

Toll-free calls on 008 — numbers allow you to telephone from anywhere in Australia for cost of a local call.



★ ★ WOMBAT ★ ★

Computer Edge is pleased to announce the release of seven WOMBAT models

The standard case WOMBAT range includes:

WOMBAT 1
WOMBAT 2
WOMBAT 3

The detachable keyboard WOMBAT range includes:

WOMBAT 1D
WOMBAT 2D
WOMBAT 3D
WOMBAT model PC-101

WOMBAT 1, 2, & 3 WOMBAT DETACHABLE KEYBOARD	CODE	DESCRIPTION	OUR RETAIL EX. TAX	OUR RETAIL WITH TAX
STANDARD CASE	1. WOMBAT 1	(W1) Basic unit with 48K RAM, numeral keyboard and upper-and-lower case.	\$625.00	\$ 695.00
	2. WOMBAT 2	(W2) Same as Wombat 1 but with 64K RAM.	\$690.00	\$ 775.00
	3. WOMBAT 3	(W3) Same as Wombat 1 but with 64K RAM and has a dual processor on the motherboard with both 6502 and Z-80 on board. Can OPERATE CP/M or Applesoft programs.	\$765.00	\$ 840.00
	4. WOMBAT 1D	(W1D) Same as Wombat 1 but comes with detachable keyboard.	\$745.00	\$ 830.00
	5. WOMBAT 2D	(W2D) Same as Wombat 2 but comes with detachable keyboard.	\$795.00	\$ 870.00
	6. WOMBAT 3D	(W3D) Same as Wombat 3 but comes with detachable keyboard.	\$890.00	\$ 965.00
	7. PC-101	(WPC) Has 64K RAM and comes with keytronics IBM-like keyboard. Runs Applesoft programs, has a sound microprocessor on board.	\$950.00	\$1045.00

NEW!! ENHANCED ORIGINAL FIRMWARE THAT INCLUDES WOMBAT BASIC AND AUTO-BOOT PROGRAMS WRITTEN IN AUSTRALIA AND FULLY COMPATIBLE WITH APPLESOFT PROGRAMS. COPYRIGHTED BY COMPUTER EDGE PTY. LTD

Standard features on all models

- ★ Compatible with all APPLESOFT programs
- ★ Typewriter style ASCII keyboard with numeric keypad and function keys
- ★ Upper and lower case
- ★ 8 expansion slots
- ★ Autostart monitor
- ★ New CMOS microprocessor — the 65C02
- ★ Enhanced WOMBAT BASIC



Standard case WOMBAT shown

RUSH YOUR ORDER TO:

Computer Edge Pty. Ltd.

229 Chapel Street, Prahran, Vic 3181. Telephone: (03) 529 7622

Hours: 9.00am — 5.30pm Mon.-Thurs. 9.00am — 9.00pm Fri. 9.00am — 12.00 noon Sat.

For toll-free calls . . . orders only, ring **008 33 1131**

Toll-free calls on 008 — numbers allow you to telephone from anywhere in Australia for cost of a local call.



DINERS CLUB



THE ROS NETWORKING SYSTEM

FEATURES

- ★ Networking system for the Apple II micro or compatible.
- ★ Replaces floppy disk drives on up to 127 independently run computers.
- ★ Can be expanded for significantly less than the cost of an additional drive.
- ★ TERRAPIN LOGO is available in a multi-user version.
- ★ ROS comes with print spooling software.



Students using the ROS Network at school

\$395 for central card and software (ex tax)
\$270 for each card thereafter (ex tax)

THE PRONET NETWORKING SYSTEM

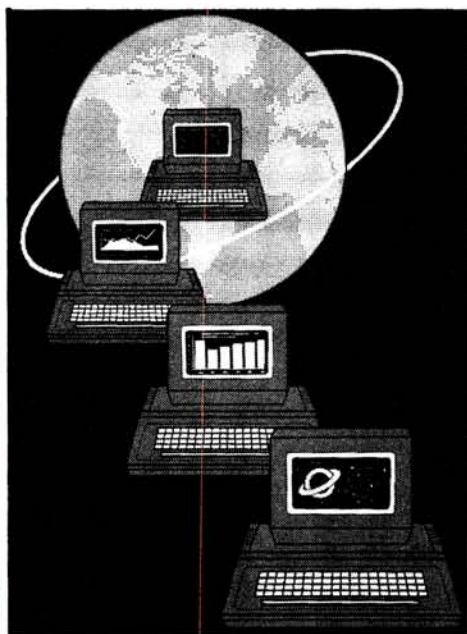

PRONET provides all the amenities of a "personal computer" with the speed and functionality of larger, more costly systems.

The PRONET links up to 128 of the most popular micro computers at distances over 5,000 feet with speeds at 4 million bits per second.

Select the multi-user operating system that suits you best, featuring **Password Security, Turnkey Command, File and Record Locking, spooling to common printers, electronic mail, educational languages and much more.**

The PRONET system emphasizes computing solutions at an affordable cost. Features found in systems costing far more are STANDARD components of the PRONET SYSTEM making networking a cost effective necessity; not an expensive luxury. The PRONET SYSTEM is a networking solution for the the serious computer user

Central Card: **\$550.00** ex tax. Remote Card: **\$420.00** ex tax

PRONET AND ROS ARE AVAILABLE FROM:

Computer Edge Pty. Ltd.

229 Chapel Street, Prahran, Vic 3181. Telephone: (03) 529 7622

Hours: 9.00am — 5.30pm Mon.-Thurs. 9.00am — 9.00pm Fri. 9.00am — 12.00 noon Sat.

For toll-free calls ... orders only, ring **008 33 1131**

Toll-free calls on 008 — numbers allow you to telephone from anywhere in Australia for cost of a local call.



Teach yourself Assembler

This month we continue our definitive introduction to assembly language programming with Paul Overaa's discussion of the 'alternation' structured building block.

Last month we defined sequence and repetition, and illustrated the ideas with a short program. This month we'll define alternation, the third and last of our structured building blocks. Simple alternation is exemplified by structured Basic's IF — THEN — ELSE type of coding. We can indicate the essential features using flowchart and Warnier diagram forms (see Figs 1 & 2).

We call this form simple alternation in order to distinguish it from those cases involving more than two alternatives. We are implying, in both representations, that any necessary preselection processing will have been performed.

A choice has to be made between two sets of actions based on a specified con-

dition. Simple or 'binary' alternation, as we have shown, represents the existence of two mutually exclusive operation subsets. The idea can be generalised to condition tests with n mutually exclusive outcomes. This leads to the corresponding existence n mutually exclusive operation subsets within the logical program description.

This month we give you an illustration of how 'alternation constructs' can be created when writing programs in assembly language. To keep to familiar ground, we'll examine a slightly more complex problem related to the 'collection of characters' program shown last month.

Problem & solution

To write a routine to collect input from a keyboard and differentiate between control and printable characters. The routine should end when CARRIAGE RETURN key is pressed. Other control characters less than ASCII value 32 are to be ignored although a warning 'Bleep' is to be given. All other input characters should be echoed to the VDU screen (see Fig 3).

The problem is well defined. We need some sort of input routine; we need to compare each collected character to see if it's a carriage return, that is, at ASCII 13 character. If it isn't, we need to know if it's another control character or a character to be printed.

Let's look at the equivalent Warnier diagram representation (see Fig 4). Note that we identify mutually exclusive subsets of actions by using a \oplus sign. Remember that only *one* of these subsets will actually be performed.

What does the diagram tell us? We collect a character using an input routine. If the input character is a carriage return then we exit from the routine. If not, we make a further test to identify whether it's a control character or one to be printed. Having performed one of two possible alternative sets of actions, we return for another input character.

How would we program this in Basic? Here's a translation of the Warnier diagram in a Microsoft Basic form:

```
10 X$="A" must force an entry into WHILE/WEND LOOP
20 WHILE ASC (X$) - 13 <> 0
```

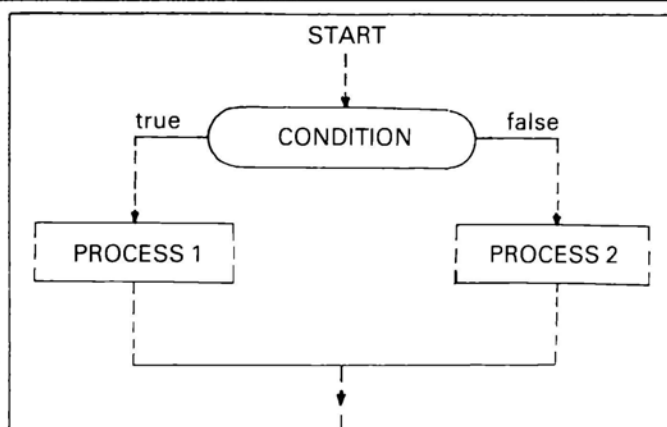

Fig 1. Simple alternation Flowchart Form

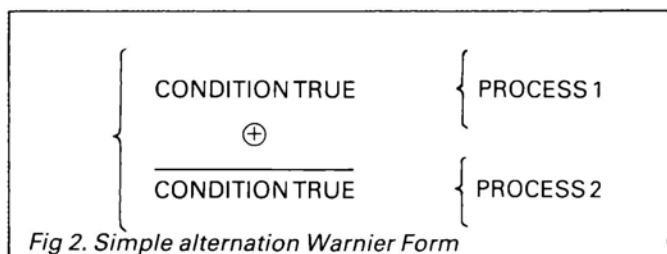

Fig 2. Simple alternation Warnier Form

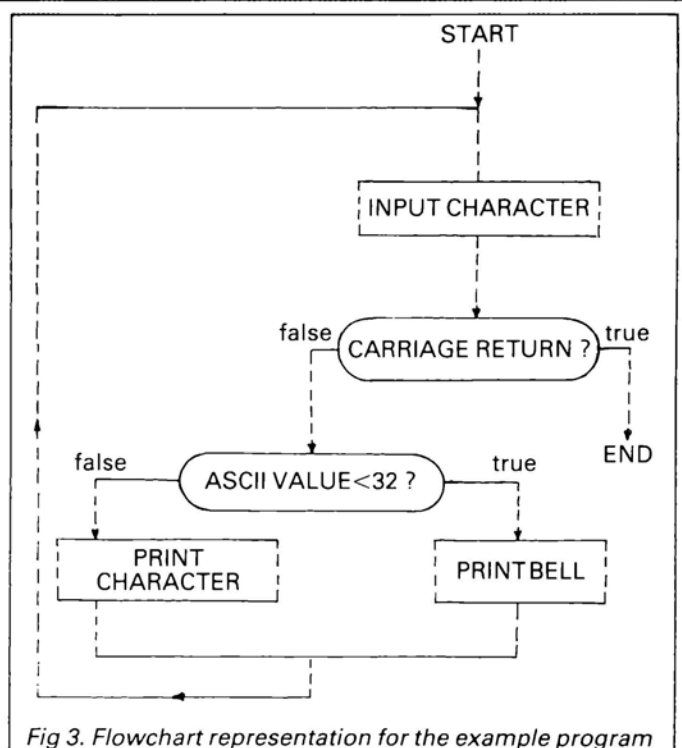

Fig 3. Flowchart representation for the example program

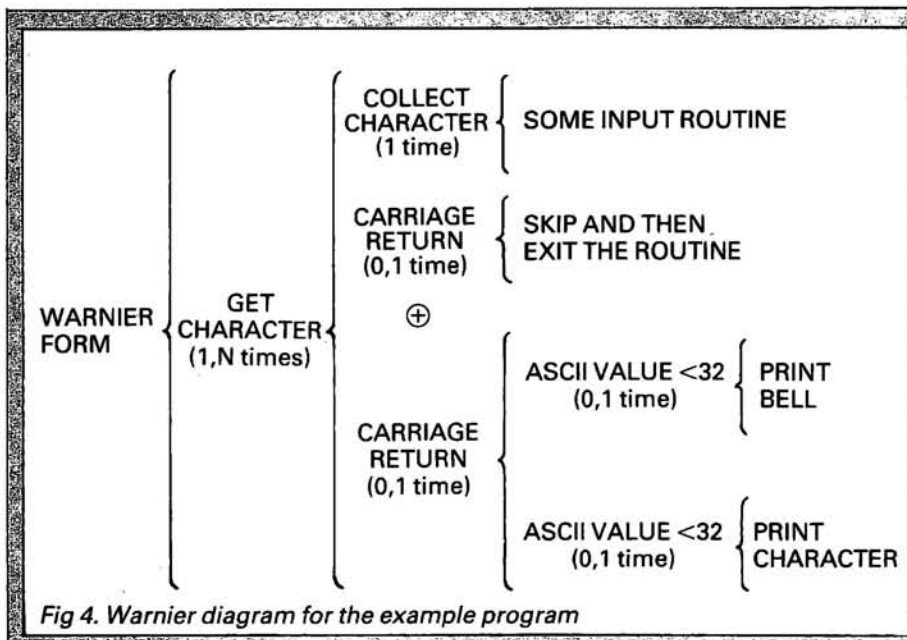

Fig 4. Warnier diagram for the example program

```

30 GOSUB 1000 ' some input routine
   collects input in X$
40 IF ASC (X$) <32 THEN GOSUB
   2000 ELSE GOSUB 3000
50 WEND
60 END

```

Subroutine 2000 will perform those actions concerned with 'printing a bell', and subroutine 3000 will concern itself with printing a character.

```

An equivalent form, and one that in
terms of coding is arguably more effi-
cient, can be obtained by using GOTO:
10 GOSUB 1000 ' some input routine
   collects input in X$
20 IF ASC (X$) = 13 THEN END

```

```

30 IF ASC (X$) <32 THEN GOSUB
   2000 ELSE GOSUB 3000
40 GOTO 10

```

Such a form is perfectly acceptable and shows a correct use of GOTO. It's only when they are used incorrectly that they create 'tangled' code that is difficult to maintain, difficult to understand and prone to errors.

You should not be misled into thinking that because a language is called unstructured, it is not possible to write well structured programs using that language.

Let's look at general ideas. We'll move on to the practical solution of our prob-

CONDITION	CARRY FLAG	ZERO FLAG
Accumulator > Immediate Byte	Cleared	Cleared
Accumulator = Immediate Byte	Cleared	Set
Accumulator < Immediate Byte	Set	Cleared

Fig 5. Carry flag operations

```

8080 — VERSION — 1
START:      CALL INPUT$ROUTINE      ;Character in accumulator
            CPI CARRIAGE$RETURN    ;End of input if true
            JZ FINISH
            CALL NOT$CARRIAGE$RETURN
            JMP START              ;Loop back for next character

NOT$CARRIAGE$
RETURN:    CPI SPACE
            CC CONTROL$CHARACTER
            CNC PRINTABLE$CHARACTER
            RET

```

Fig 6. 8080 interpretation

```

8080 — VERSION — 2
START:      CALL INPUT$ROUTINE      ;Character in accumulator
            CPI CARRIAGE$RETURN    ;End of input if true
            JZ FINISH
            CPI SPACE
            CC CONTROL$CHARACTER
            CNC PRINTABLE$CHARACTER
            JMP START              ;Loop back for next character

```

Fig 7. Efficient 8080 coding

lem later. We're dealing with a particularly simple form of alternation, which is usually coded in its own special and very simple way.

Carry flag

Last month we used 'immediate' comparison instructions to test for equality. The instructions used were the 8080's CPI operand, the Z80's CO operand and in the case of the 6502 we used CMP # operand. When the contents of the accumulator are the same as the immediate byte specified, then the internal subtraction that occurs during the comparison results in the zero flag being set.

When these comparison instructions are used, several other flags are affected. Our present concern is the effect of these operations on the carry flag. We can tabulate all possible outcomes of such testing as in Fig 5.

In all cases, the contents of the accumulator, and of the immediate byte value specified, are treated as simple binary data.

We use the carry flag to detect control characters. For the purposes of our example, we define a control character as one having an ASCII code of less than 32.

8080 form

Let's look at the main part of an 8088 assembly language interpretation of these forms (Fig 6) and make some observations.

The 8080 mnemonics CC and CNC stand for 'call on carry' and 'call on not carry' respectively. They illustrate the concept of a conditional subroutine call, whose function is to perform the specified subroutine call, but only if the necessary flag condition is satisfied.

A more efficient form of coding is shown in Fig 7. It's more compact and satisfies the requirements of our problem, but you'll see later that problems can occur which, at present, are not immediately obvious.

We use an input routine to collect a character: this is required in the accumulator register. The CPI instruction compares the value of CARRIAGE\$RETURN (which will have been previously set to 13 by an EQU directive), to the ASCII value of the character present in the accumulator. If the character present in the accumulator is a carriage return the zero flag will be set. As in the first form, the JZ instruction following this means we exit from the routine as soon as a carriage return character is detected.

If the character being looked at is not a carriage return, then we compare the

FT-500 Dot Matrix Printer

Low-cost and reliable
with graphic capability
Elite, Pica typefaces
Enhanced with selectable
62 characters memory capacity
100 CPS & MUCH MORE

FOR
VERY
LITTLE
(\$408 Inc Tax)

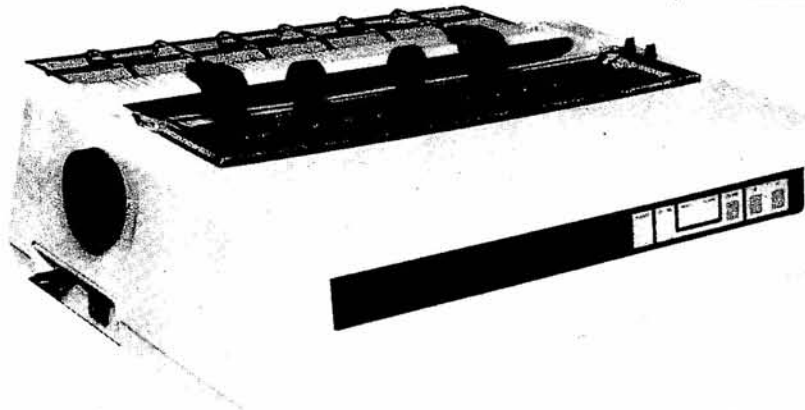
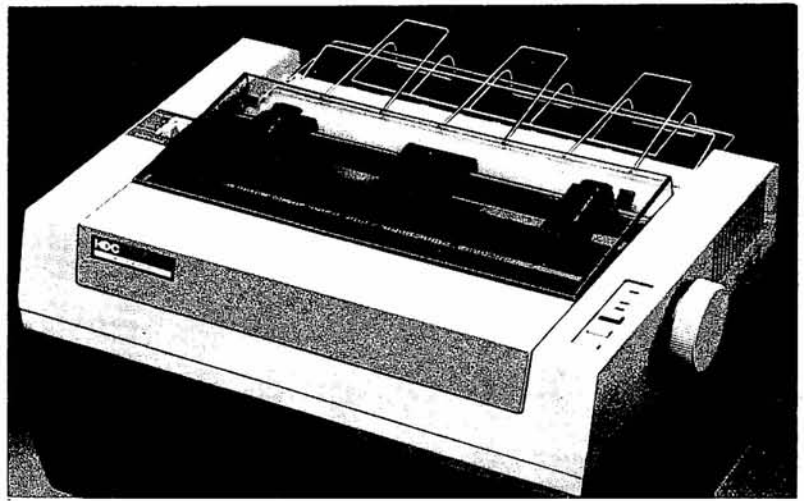

**WP550
(RS232 & PARALLEL)
DAISY WHEEL PRINTER**

HIGH QUALITY
AT A LOW PRICE

(\$708 Inc Tax)

INCLUDES FRICTION
& TRACTOR FEED

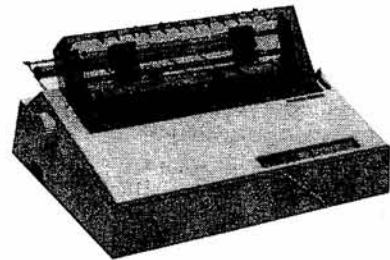

**BROTHER HR15
DAISY WHEEL PRINTER
(\$708 Inc Tax)**

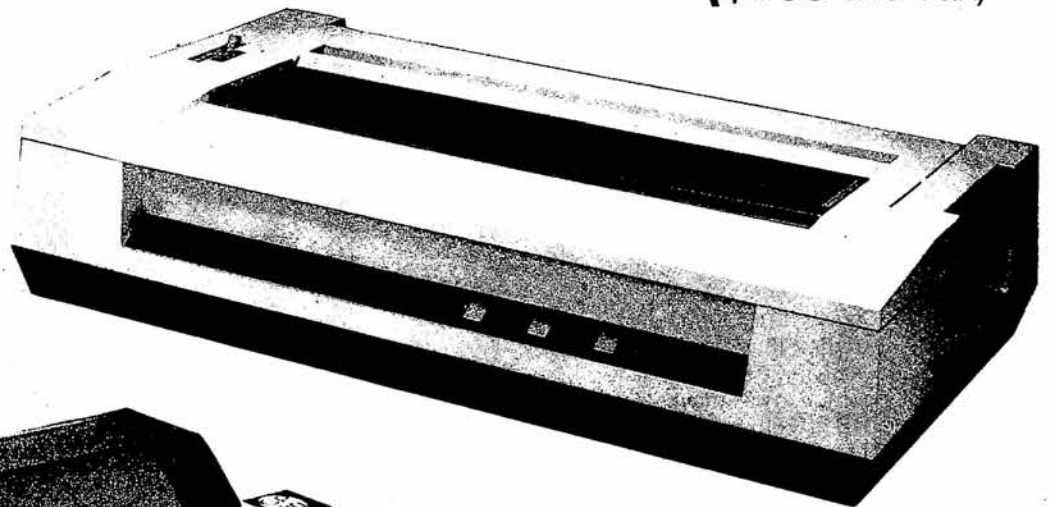

**C ITOH 1550
15" WITH THE LOT
Tractor & Friction Feed
(\$900 Inc)**



**CP80
(EPSON WORKALIKE)
80 cps; 80 Columns;
Tractor Feed; Friction Feed
(\$360 Inc Tax)**

MICRO ~ BUFF

**TELEX AA 139718
TELEPHONE 277 7754 (ASK FOR RAY POPE)**

**499 HIGH STREET ROAD,
MT WAVERLEY 3150
MELBOURNE, VICTORIA,
AUSTRALIA**

accumulator contents to the value SPACE (again previously defined by using an EQU directive). If the character present in the accumulator has an ASCII value less than 32, that is, if it's a control character, then the 8080's carry flag will be set. Otherwise the carry flag will be clear.

In both of these examples, we are using the carry flag to implement the equivalent of an IF — THEN — ELSE structure. If the carry flag is set we do one set of operations; if the carry flag is not set we perform the alternative set of operations. The only necessary stipulation is that the status of the flag being tested must be preserved by the first of the subroutines to be called.

Control\$character subroutine

This has to output a bell character. On most terminals this is done by sending the ASCII bell character to the terminal. In Basic you use PRINT CHR\$(7); in assembler a register is loaded with the value 7 and then the system output routine is used to send the character to the terminal. The normal procedure is to define BELL by an equate pseudo operation and the example shown assumes that this has been done:

8080 VERSION

```
CONTROL$
CHARACTER: MVI  A,BELL
             CALL OUTPUT$ROUTINE
             RET
```

To load the accumulator we are using the instruction 'MVI A,data': this is an example of a 'move immediate' instruction. The data byte following the op code is transferred to the specified register. We are specifying the accumulator, but it's also possible to use the instruction to load either B,C,D,E,H or the L registers. Note that we have now seen two immediate load 8080 instructions. MVI is used to load 8-bit values into a selected register. LXI is used to load a 16-bit value into a selected register pair (we used it last month to set up the stack pointer).

Printable\$character subroutine

This simply has to output the character present in the accumulator, that is, it's your system output character routine.

Z80 form

The Z80 has conditional subroutine call capability similar to the 8080 processor. The syntax expected for the conditional subroutine calls is slightly different but this does not affect the essential ideas. We'll give the equivalents of the two ver-

Z80 VERSION 1

```
START:      CALL INPUT$ROUTINE      ;Character in accumulator
             CP  CARRIAGE$RETURN    ;End of input if true
             JP  Z,FINISH
             CALL NOT$CARRIAGE$RETURN
             JP  START              ;Loop back for next character

NOT$CARRIAGE$
RETURN:     CPI  SPACE
             CALL C,CONTROL$CHARACTER
             CALL NC,PRINTABLE$CHARACTER
             RET
```

Z80 VERSION 2

```
START:      CALL INPUT$ROUTINE      ;Character in accumulator
             CP  CARRIAGE$RETURN    ;End of input if true
             JP  Z,FINISH
             CP  SPACE
             CALL C,CONTROL$CHARACTER
             CALL NC,PRINTABLE$CHARACTER
             JP  START              ;Loop back for next character
```

Fig 8. Z80 forms for 8080 code

sions of the 8080 code (Fig 8) and then explain why the version 1 forms have possible advantages.

The Z80 has equivalent instructions to load a specified register with an 8-bit data value. The mnemonic LD, when used in the form 'LD register, 8-bit data value', is representing an instruction identical to the 8080's MVI. (When used in the form 'LD register pair, 16-bit data value' it is equivalent to the 8080's LXI instruction).

The LD mnemonic is, however, also used to represent register loading operations other than the loading of immediate data values. Some have 8080 equivalents that use different mnemonics, some do not have 8080 equivalents at all. Bear in mind for now the main distinction, viz: MVI and LXI on the 8080 are register loading instructions that use immediate addressing; that is, the operand is the bytes in memory that follow the op code (the instruction byte itself). LD on the Z80 processor, when used as shown, is using immediate addressing: additionally, it's used to represent data transfer using other addressing modes.

Go back now and look at the flowchart we are using for the example program.

Z80 VERSION

```
CONTROL$
CHARACTER: LD  A,BELL
             CALL OUTPUT$ROUTINE
             RET
```

6502 VERSION

```
START:      JSR  INPUT$ROUTINE
             CMP  #CARRIAGE$RETURN
             BEQ  FINISH
             JSR  NOT$CARRIAGE$RETURN
             JMP  START

NOT$CARRIAGE$
RETURN:     CMP  #SPACE
             BCC  N$C$R$1
             JSR  CONTROL$CHARACTER
             RTS

N$C$R$1:    JSR  PRINTABLE$CHARACTER
             RTS
```

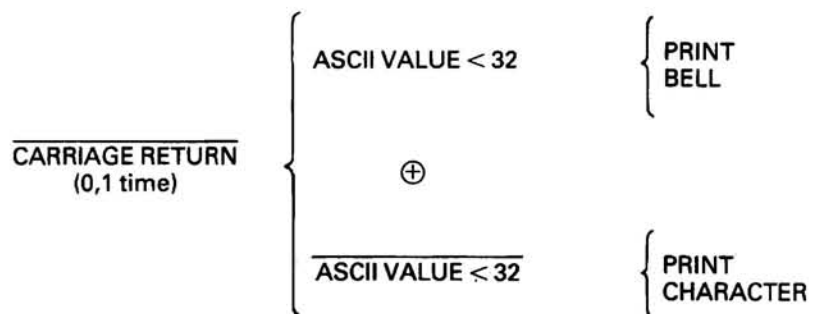
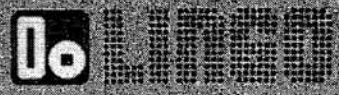

Fig 9. LD on the Z80 processor

NEW RELEASE



- ★ 6502 & Z80 CO-PROCESSOR
- ★ 128K RAM MEMORY
- ★ SELECTABLE 40/80 TEXT DISPLAY
- ★ CENTRONIC PRINTER OUTPUT
- ★ RS-232C SERIAL I/O
- ★ RGB COLOUR & PAL VIDEO OUTPUT
- ★ 6 EXPANSION SLOTS
- ★ UPPER & LOWER CASE
- ★ NUMERIC PAD & FUNCTION KEYS
- ★ AUTO/FAST AUTO REPEAT KEYS
- ★ 4 DIRECTIONS CURSOR CONTROL
- ★ GENUINE JAPANESE POWER SUPPLY

*Runs...
DOS, CP/M,
UCSD Pascal*



SPECIAL OFFER
UNTIL 31st APRIL 1984
\$2295.00 (INC TAX)

- ★ HIGH RESOLUTION GREEN MONITOR
- ★ DUAL PRECISION DRIVES
- ★ SANDY'S WORD PROFESSOR **FREE!**

DIGITAL SOURCE INT'L PTY. LTD
(AUSTRALIAN IMPORTER)

**DEALER ENQUIRIES
WELCOME**

169 Phillip Street, Waterloo N.S.W. 2017. Telephone: (02) 690 1268, 690 1540. Telex: AA 75406

Can you pick out the subset of actions associated with 'not finding a carriage return character'? You'll probably agree that even in this simple example, the isolation of such subsets is not particularly obvious.

Try to find the same subset on the Warnier diagram. (Remember that we write the logical opposite of a statement by placing a bar over the statement.) The subset we are discussing is shown in Fig 9.

The reason we're particularly interested in this subset is because the 8080 and Z80 first versions explicitly treat the coding involved as a distinct subset; that is, actions corresponding to 'not carriage return' were implemented as a 'called subroutine'. The code is therefore related to the design diagram on this basis: the action subset is defined by coding as a subroutine. The advantage is that the structure of the diagram and the coding is isomorphic (a word used by mathematicians to imply structural similarity.)

The coding in the second version performs the same function as the coding in the first, but the action subset 'not carriage return' is not explicitly defined in the second form of code. The difference may not be immediately apparent to you, so let's briefly digress to explain this point.

There is a real advantage, especially when writing large assembly language programs, in being able to easily locate the section of the code that is relative to a particular action subset in the corres-

ponding design diagrams. Such advantage is paid for by a slightly increased program size.

Hardcore assembly language programmers often take great exception to 'wastage of bytes' in this manner, and for certain applications their objections are justifiable. Our defence in general terms is two-fold. Firstly, it's often of great practical advantage to have isomorphic coding with the design diagrams. Secondly, memory is getting cheaper but debugging is not. Explicit subset definition based on isomorphism between the design diagram and the actual program code contributes in practice to significantly reduced debugging time. The message is simple — save bytes by all means, but distinguish carefully between pointless inefficiency and the deliberate choice of using a few more bytes to create code that can easily be compared to the design diagrams.

6502 form

Our 6502 processor cannot perform conditional subroutine calls. We must therefore find a way of creating such a facility. One fairly obvious solution involves using the 6502's relative branch instructions to select an appropriate subroutine (several of these are available). Since we're using the carry flag to detect control characters we can use the 'relative branch on carry clear' (whose mnemonic is BCC). With only

slight rearrangement we can also use the complementary test BCS, which is the 'branch on carry set' instruction. The bulk of the code shown (see previous page) should be familiar, the differences are due only to the absence of conditional subroutine calls on the 6502.

Don't be fooled by the presence of two RTS instructions — only one will actually be performed; that is, if the carry is set then the conditional relative branch is not performed, so we can execute the CONTROL\$CHARACTER subroutine followed by a return instruction. If the carry is clear, the relative branch is performed, then PRINTABLE\$CHARACTER is performed followed by the alternative return instruction.

6502 VERSION

```
CONTROL$
CHARACTER: LDA # BELL
           JSR OUTPUT$ROUTINE
           RTS
```

The CONTROL\$CHARACTER subroutine in 6502 form is similar in principle to both the 8088 and the Z80 forms, we simply load the accumulator with the BELL character. The mnemonic used is LDA# data (the '#' sign is a 6502 mnemonic convention that indicates the operand is to be obtained from the next byte in memory; that is, it's signifying an 'immediate addressing' mode.

Fig 10. Modified flowchart for the example program

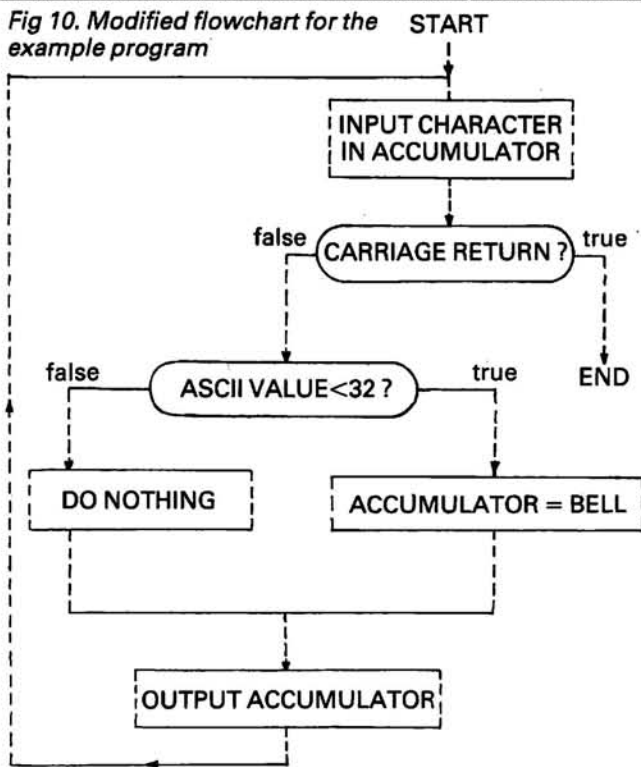

8080 PRACTICAL SOLUTION

```
START: CALL INPUT$ROUTINE
      CPI CARRIAGE$RETURN
      JZ FINISH
      CPI SPACE
      JNC PRINT$CHARACTER
      MVI A,BELL

PRINT$CHARACTER: CALL OUTPUT$ROUTINE
                JMP START
```

Z80 PRACTICAL SOLUTION

```
START: CALL INPUT$ROUTINE
      CP CARRIAGE$RETURN
      JP Z,FINISH
      CP SPACE
      JP NC,PRINT$CHARACTER
      LD A,BELL

PRINT$.CHARACTER: CALL OUTPUT$CHARACTER
                JMP START
```

6502 PRACTICAL SOLUTION

```
START: JSR INPUT$ROUTINE
      CMP # CARRIAGE$RETURN
      BEQ FINISH
      CMP # SPACE
      BCC PRINT$CHARACTER
      LDA # BELL

PRINT$CHARACTER: JSR OUTPUT$ROUTINE
                JMP START
```

MICRO ~ BUFF

TELEX AA 139718
TELEPHONE 277 7754 (ASK FOR RAY POPE)

499 HIGH STREET ROAD,
MT WAVERLEY 3150
MELBOURNE, VICTORIA,
AUSTRALIA

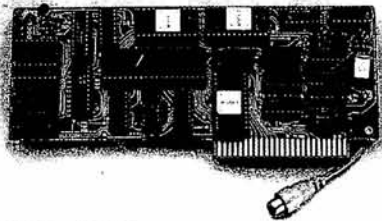

80 COLUMN I/F

80 x 24 Lines
Lo Res Graphics
Compatible with
Word Processors in
BASIC, CP/M or
PASCAL

\$85.00 Tax Paid

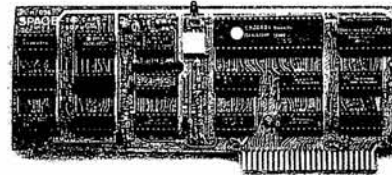

CP/M CARD

Turn Your Apple
into the most
Powerful
Business
Computer

\$55.00 Tax Paid

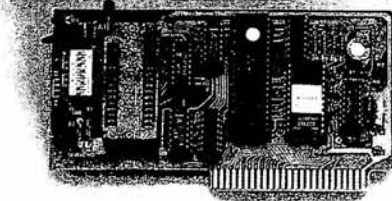

EPROM WRITER

2716, 2732, 2764
Does them all
AUTO Blankcheck
AUTO Verify
Read, Write, Copy,
Includes software

\$83.00 Tax Paid

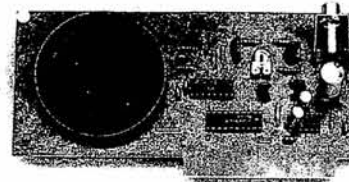

S. A. M.

ADD SPEECH
TO YOUR
COMPUTER
SOFTWARE
INCLUDED

\$39.00 Tax Paid

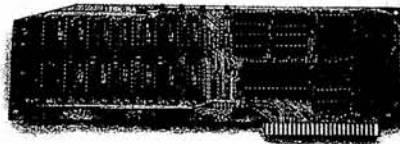

128K RAM CARD

Super-Fast Disk
Immulation or
Just Total
Expansion of
Memory Software
Included

\$225.00 Tax Paid

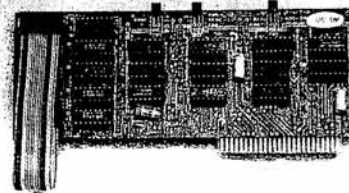

16K RAM CARD

Make Your
Old APPLE
into a 64K
Computer
32K also available

\$89.00 Tax Paid

GET SLOTTED

SUIT ALL APPLE
TYPE COMPUTERS

THE AFFORDABLE PLACE TO SHOP

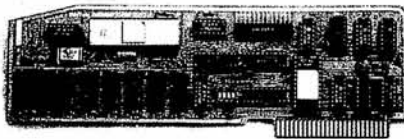

BUFFERED PRINTER INTERFACE

Centronics (Parallel)
Compatible 16K —
64K Buffer Text or
Graphics same as
Grappler Cards

\$160.00 Tax Paid

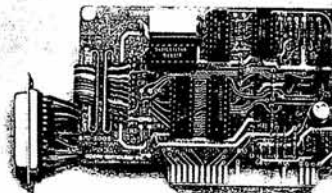

SERIAL RS232

For PRINTERS
or MODEMS
Fully
Programmable

\$75.00 Tax Paid

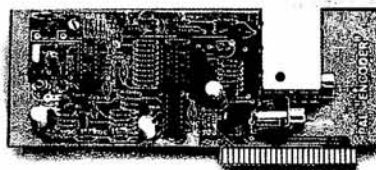

PAL INTERFACE

Connect to your TV
For the Colour of
Your Enjoyment

\$95.00 Tax Paid

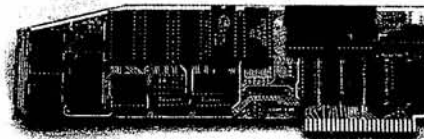

8088 INTERFACE

MSDOS (IBM)
or
CPM 86
Speeds up
the APPLE
Includes software

\$269.00 Tax Paid

DISK DRIVES

800K SINGLE **\$700.00**
1.600K DOUBLE **\$980.00**

5 1/4" DISK DRIVES BY TOSHIBA

**INTERFACE CARD BY MICRO BUFF
COMPLETE WITH SOFTWARE**

Teach yourself Assembler

Practical solutions

We have used our example to explain some general ideas. There is a very good reason why you would not, in practice, actually need to write subroutine based code for this particular example. Look back at some of the coding and think how we output printable characters, and how we output the ASCII bell character. In practice, we'll be using the accumulator to output the printable characters: we'll also use the accumulator to output the bell character. We will also, in both cases, be using our system OUTPUT\$ROUTINE to send the character to the terminal.

The practical implementation of our problem has a certain amount of com-

mon ground that has not been used in our earlier general discussions. We now consider and modify our flowchart/design diagrams in the light of the above information (see Fig 10).

When we consider fully the practical implementation of our problem we see that one of the alternation subsets is a 'do nothing' process.

This type of structure is frequently handled by simple in-line conditional relative branching or conditional jumping. Based on a condition, we either perform some section of code, or avoid it by jumping over it. Bear in mind that this type of structure is a subclass of the simple alternation we first dealt with. There are still, from a theoretical viewpoint, two sets of actions. The distinction is that one of the subsets is an 'empty set'.

Having possibly struggled through some of the ideas we have presented so far, you will no doubt be pleased to see the assembly language code that results from our most recent efforts. If you've persevered up to this point, you should find the code fairly straightforward. In all three cases, the label PRINT\$CHARACTER identifies the location to be jumped or branched to if the carry flag is not set.

You should now appreciate the relationship between simple alternation where two subsets of actions are

involved, and the specific case of simple alternation where one of those subsets is an empty set. This month we've shown some of the ways in which the corresponding code can be written.

Last word

The design of our solutions is derived from the logical examination of the problem.

The logical solution exists as an independent entity, and by having such solutions available before you start coding you will side-step many problems that other approaches walk straight into.

Using this approach, we find that we're left with the much smaller problem of how to use an available instruction set to implement an already known logical solution. We would like you to think about the implications (and in particular the benefits) of having language independent solutions available before coding is started.

If last month's 'main block' is modified to incorporate this month's practical solutions you should be able to run a version of the given problem; you might also like to experiment with some of the other ideas we considered.

RABBIT for C-64 & VIC



- backup expensive software tapes
- high speed load, save and append
- data file handling
- cartridge convenience

RABBIT loads or saves 8k in 30secs; tape takes 3 mins

\$62.50 (incl postage)

from

TARDIS CORPORATION
Main road, Franklin, TAS.

pay by Bankcard or Visa, give number and expiry date.



BASF

Introducing a totally new level of excellence in magnetic media — the "qualimetric" standard. The "qualimetric" standard is maintained without compromise through every step of BASF design, production, inspection, and testing... reflecting an unwavering BASF commitment to media fidelity and durability.

For information security, tomorrow and beyond, look for the distinctive BASF package with the "qualimetric" seal.

SPECIAL OFFER:

Box of 10 Flexydisk 5.25, single sided, single density, in de Luxe library case for **\$35.00**

Free delivery anywhere in Australia

Comprehensive range in diskettes and computer tapes



Fill out coupon and return with cheque to

PERIMEDIA PTY LTD

P.O. Box 157,
Macedon 3440
Ph: (054) 26 1304
(03) 656 1178

Company Name

Address

Phone

boxes of BASF Flexydisk 5.25 s/s

daisywriter®

No other daisywheel printer gives you this many features for such a low price!

***INTERNAL 48K BUFFER MEMORY —**

Now you can forget waiting while your computer feeds your printer. Daisywriter lets you process and print simultaneously, it holds up to 30 pages of text and frees up the processor to do other tasks.

UNIVERSAL INTERFACE —

from Apple to Xerox and Commodore through IBM-PC to TRS-80. Daisywriter will connect to any processor with RS232, Centronics, IEEE or current loop interfaces.

COMPLETE RANGE OF PROTOCOLS — from

Applesoft to Zardax and Multiplan to Visicalc. Daisywriter will run with virtually any software.



Only \$1986*

HIGH SPEED PRINT THROUGHPUT —

bi-directional printing with high speed logic seeking ability enables Daisywriter to ZIP over white space on the page at up to 200 cps.

HIGH RELIABILITY — runs on a linear motor — no belts, pulleys or wheels to wear and require adjustment.

LOW RUNNING COST — uses easily loaded daisywheel cassettes and standard IBM typewriter ribbon cartridge.

GRAPHICS — full graphics capability.

INTERNAL SOFTWARE COMMANDS — more than 75 software commands to give you true proportional spacing and speed up your word processing.

CUTSHEET AND TRACTOR FEEDERS — available as options.

*Price does not include sales tax

PSI
Incorporated in N.S.W.

PAPERWORK SYSTEMS INC. (GROUP) PTY. LTD.

HEAD OFFICE: 14th FLOOR, 124 WALKER STREET, P.O. BOX 3511, NORTH SYDNEY N.S.W. 2060 AUSTRALIA. TELEPHONE: (02) 922 5322. TELEX: AA23981
3 BOWEN CRESCENT, MELBOURNE VICTORIA 3004 AUSTRALIA. TELEPHONE: (03) 267 7555

PREVIEW

In one of the most important micro launches of the year, IBM unveiled a portable version of its massive success story, the PC. Steve Birchall sent this exclusive review from Boston and also considers the Portable PC's position in the market.

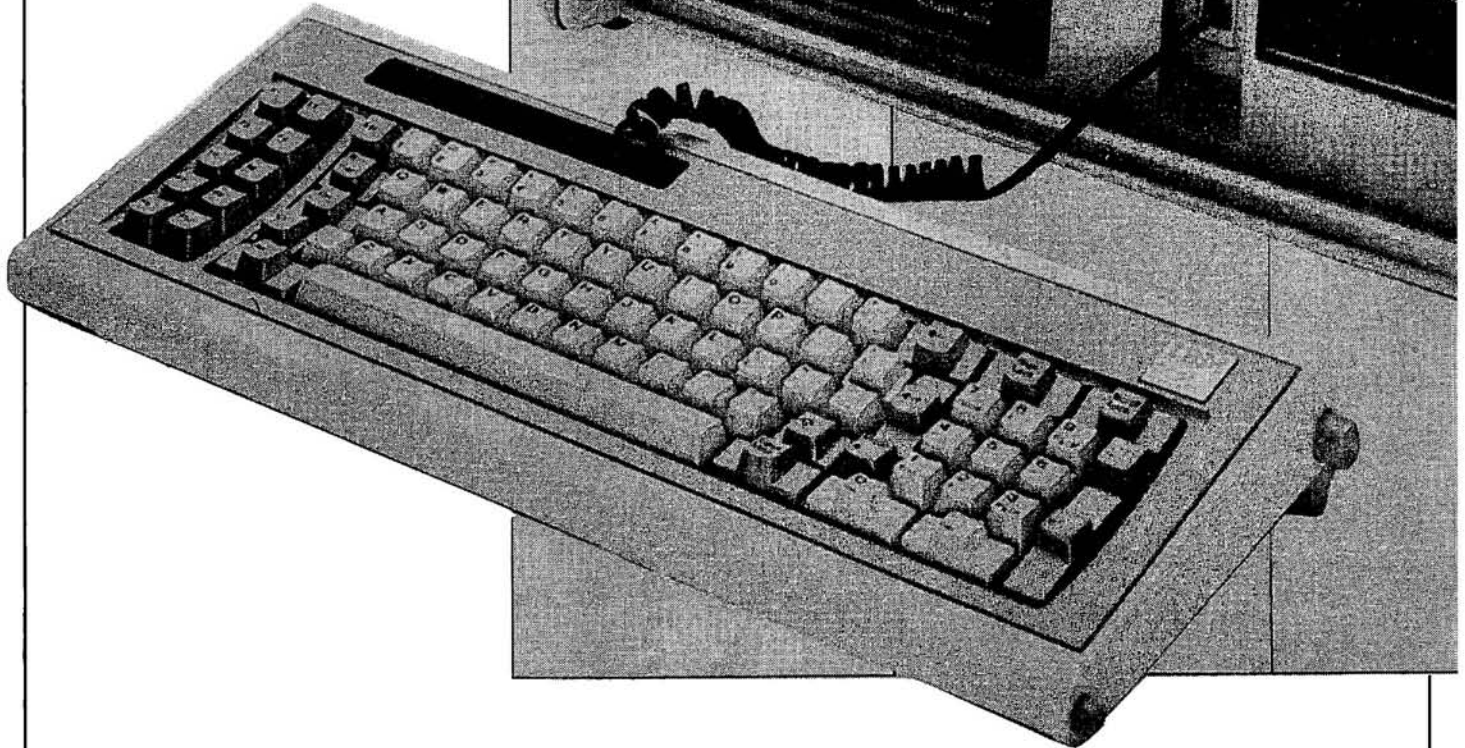

PC ON THE MOVE

Imagine a compact, lightweight portable version of the IBM PC, which you can take almost anywhere. It runs nearly all software from other members of the PC family. It comes with a 9in amber monitor, one disk drive (with space for an optional second drive), 256k of RAM (expandable to 512k), and a colour graphics adaptor card. An optional modem lets you talk to your main PC system back at the office or lab.

This is the new Portable Personal Computer announced by IBM in February. Neatly packaged in a rugged carrying case, the system weighs just 30lb, measures 20 x 17 x 8 inches, and in the basic configuration sells for \$2,795.

To make the four member PC family more useful, IBM also announced the Cluster system, which permits a user to interconnect as many as 64 machines in a simple network. The main 75 ohm

coaxial cable can be up to 3,280 feet long, and individual drop cables can be up to 16 feet.

This type of cable is less expensive than those normally used in a network. For a typical small Cluster of five computers, the system cost is about \$2,540 on top of the individual computers.

Presentation

The Portable PC looks similar to the work-alikes made by companies such as Kaypro and Compaq. The detachable keyboard is identical to the standard PC keyboard, and connects to the main unit with a coiled cord stored in a recessed opening in the keyboard module.

When folded into place for transit, the keyboard covers and protects the front panel, where the monitor and disk drive are. A thoughtful feature is the shielded disk storage just above the top disk drive.

At the other end of the main unit, a carrying handle folds up from the back panel.

The outer skin is a rugged, impact resistant plastic material, which surrounds the rigid metal chassis. To protect it from scuffs and scratches, IBM provide a soft nylon carrying bag in 'Big Blue' with an IBM logo on a little designer tag. The bag is well made and has a padded carrying strap.

Weight distribution seems well thought out. The machine balances fairly evenly in all dimensions — an important feature when carrying it around. Thirty pounds is not uncomfortable, particularly when the components are nicely balanced, but the unit should weigh less. Perhaps they decided to trade off a few extra pounds for the advantages of a more rugged unit.

The Portable PC is the kind of computer you can imagine a geologist taking to a remote location to search for oil. An accountant might take one along when calling on a client, thus gaining access to

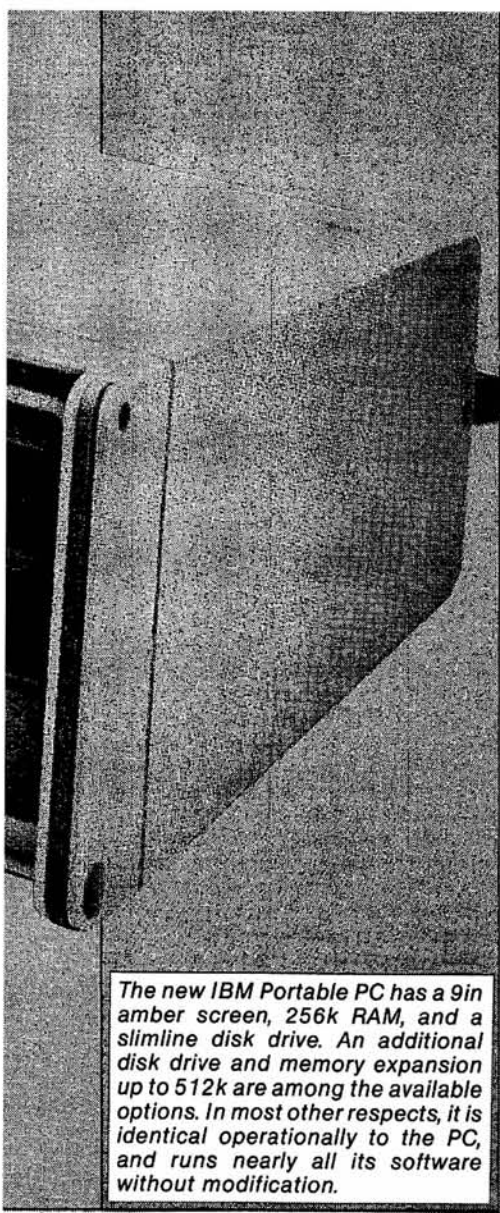

The new IBM Portable PC has a 9in amber screen, 256k RAM, and a slimline disk drive. An additional disk drive and memory expansion up to 512k are among the available options. In most other respects, it is identical operationally to the PC, and runs nearly all its software without modification.

the mainframe database while working at the client's offices. A busy executive might take one home for an evening or a weekend of report writing. A student might use one late at night to access the library.

The new world of possibilities offered by IBM's Portable PC is fascinating, but it does have limitations. Bear in mind that its size and weight keep it out of the notebook or lap computer category. Its power consumption requires a mains connection rather than battery operation. You won't see students with Portable PCs taking notes in a lecture hall or businessmen using them to juggle accounts on the commuter trains. This computer is simply a transportable version of the PC and will compete with such machines as the Kaypro and Osborne.

The standard configuration has a single slimline (half-height) disk (second drive optional), and 256k RAM (upgradeable to 512k with the memory expansion card).

In a certain sense, this is a boring new product. IBM wisely decided to introduce nothing more than portability. Because of that restraint, the Portable PC is the perfect addition to their PC range. Functionally, the Portable PC is identical to the standard model in nearly every respect. It can exchange data freely by means of disk, modem or Cluster connection with other models (with only a few minor system-specific exceptions).

Storage

The new slimline disk drives occupy half the height of the older drives. They use 5¼in double sided, double density diskettes and, with DOS 2.1, can store up to 360k per disk. These are the same drives IBM introduced on the PCjr, and are 41.6mm high, 146mm wide, and 208mm deep. The optional second drive can be installed by the user, adding about 2½ pounds to the overall weight.

Construction

Inside, the Portable PC has seven slots (three hold full-size cards, and four are for short cards). Of these seven slots, two long ones are occupied by the disk drive controller and the monitor display cards. The Cluster Adaptor card, if used, occupies the remaining full-size slot. All IBM special purpose cards (such as the modem or the various printer controllers) are interchangeable from model to model.

The Intel 8087 math co-processor is also available on the Portable for those needing high speed number crunching capability.

The universal power supply operates on 115 or 230V (selectable by setting a rear panel switch) at either 50 or 60Hz. A variety of power cords is available to accommodate different types of mains connections.

The chassis is divided into two halves, separated on top by a rigid metal divider. On the left is the monitor tube, with a shield, and the power supply; on the right, the main circuit board (identical to the PC XT mother board), which occupies the entire bottom of the chassis. Attached to it are the receptors for the seven circuit cards.

Near the front is the disk drive and its shielding. The bottom being one piece gives added rigidity to the structure. Significantly, the Portable PC comes with a twelve month guarantee: IBM knows it will suffer many hard knocks in use.

On the back, recessed under a hinged flip-down cover, are a connector for the printer and another for an external monitor. Blank panels for each of the other slots permit you to attach appropriate

connectors for other peripherals. Another connector accommodates the mains cord. Nearby is a switch for 230 or 115V operation, and the system on/off switch. The sides are free of connectors or controls.

Compatibility — any quibbles

All members of IBM's PC family (the PC, PC XT, PCjr, and the Portable PC) use the Intel 8088 chip and the same Operating System, so software generally works on all systems.

However, since each member of the PC family has certain unique capabilities, there are exceptions.

- The small number of PC programs which rely specifically on the monochrome display will not run on the Portable.

- PCjr software which exploits its enhanced colour graphics must be modified to run on the other systems. IBM has a set of guidelines available.

- Software for the PC XT which requires the hard disk and extra memory will not work on the other systems.

It's that compatibility that is important to the user of this family, both in terms of data and software. Also, special purpose cards such as the IBM modem or the various printer controllers work in every model interchangeably. If a card becomes defective you can borrow one from another machine for a quick emergency fix. In a small office, school, or research facility a Cluster of PCs permits people to send messages and data to each other freely. When an executive is finished with a financial analysis it can be sent to a secretary to format it and print it out. Or it might go straight to a colleague for comment. Add a few Portables to the mix and instant input of data from remote locations is possible.

Unfortunately, while IBM have made all the PCs compatible with each other, they have not made them compatible with other IBM product lines. When Douglas LeGrande (Vice President of Operations for the Entry Level Systems Division) presented the Portable PC to the Boston Computer Society he was asked if the PC Cluster could exchange data with the Display Writer. The answer was no. Also, the Cluster can not communicate with the outside world through a modem. However, you can connect the 3270-PC to a Cluster to gain access to mainframes. They have not had time to test the XT/370 for this capability.

Screen

The amber monitor is easy to read and displays 25 lines of 80 characters. For colour displays you may also connect an external color monitor, which runs simultaneously with the internal monitor. At last month's Boston Computer

Society meeting LeGrande emphasised IBM's growing belief in the importance of colour displays. The new PCjr has enhanced colour graphics capabilities which the other members of the family don't have. The Portable PC is the first model to include the relatively expensive

colour/graphics adaptor card as standard equipment. Most of the IBM accessories work on the Portable, including the new colour printer. It looks very much like an updated version of the popular IDS Prism printer. This dot matrix printer uses a ribbon with four colour

Where to, Big Blue?

As has become usual with IBM micro releases, IBM Australia has no immediate plans to release the portable version of the IBM PC in this country, nor does it speculate on its future plans. In the US, however, the impact of the machine will be fairly immediate. It's not so much that the Portable PC represents the latest and greatest in computer technology, it's simply that it represents the first step in what has long been feared as IBM's ultimate objective — to muscle in on the huge ancillary market created by its initial strategy.

IBM's PC surprised the industry by offering a reasonably open system. Not only did the PC use an operating system from another company (Microsoft), but the machine itself incorporated an Apple-style bus system which enables other companies to configure cards for features like serial communications, extra memory and so on.

As a newcomer to the personal market, IBM obviously felt its best course of action was to cash in on some of the expertise already available in other companies.

Apple adulation

Apple's introduction of the Lisa and Macintosh was the opening round of the impending battle between Apple and IBM. When AT&T unleashes its home computer this autumn, even the apparently impregnable IBM may suffer some battle scars. Lurking in the background are the Japanese manufacturers, who are already promoting software compatibility with their MSX standard. Though IBM and AT&T are formidable competitors, we must remember that the Japanese were able to bring the American automobile industry to its knees.

A clear indication of how the forces are beginning to line up is the difference between two recent meetings of the Boston Computer Society. At the January meeting, Apple's Steve Jobs introduced the Macintosh with an expensive, well-executed multi-media presentation. The BCS had to rent a larger hall for the occasion, and still over 2000 people were turned away. Those

lucky enough to get in were wildly enthusiastic about the power of the Macintosh and its elegantly simple user interface. Cheers and applause interrupted the show frequently. Apple has a computer that people can learn to use in 20 minutes. Macintosh cuts through all the red tape of tedious menu choices or complex command strings. Point at what you want, push a button, and watch while the computer carries out all those boring instruction sequences.

A month later, when Douglas LeGrande from IBM introduced the new Portable PC, PCjr, and Cluster network system to the BCS the presentation was surprisingly plain vanilla: he gave a simple, low-key speech with not a computer on display — not even a picture of one. The computers were all waiting downstairs for hands-on demonstrations.

What IBM wanted to suggest was an easy-going style. But the meeting had all the excitement of a banker's convention: no cheers or applause interrupted this speech. The crowd number was normal for a BCS meeting — but fewer people were in attendance than had been turned away from the Apple meeting. At the hands-on demos, the participants evinced the quiet, serious intensity of businessmen evaluating a new piece of equipment.

Clearly, Apple has gained powerful customer loyalty, and has developed an exciting new product. IBM, on the other hand, has acquired experience dealing

with the consumer market only during the past two and a half years. It is still exploring this strange new world and only beginning to understand how to work successfully in it. The new product presentation was adapted from IBM's approaches to the business market. Since IBM has the money and personnel to make any kind of presentation they want, we can conclude they simply do not understand what they need to do if they want to compete in that arena. That may change, but will the change come soon enough?

AT&T will soon introduce a new home computer. Like IBM, it has no problems with manufacturing or technological innovation. Unlike IBM, it has a significant amount of experience in selling technology to home users. 'Human engineering' has always been one of its fortes, and the AT&T home computer may be one of the easiest to use so far. AT&T may also have a significant edge over IBM as, in the US, they have a more familiar brand name.

The Japanese are playing a different game, and have quite a few tricks up their sleeves. Obviously, they can make consumer electronics gear more cheaply than anybody else. But their real strategy involves standards and compatibility. Most of the Japanese manufacturers have agreed on the MSX operating system.

Half-blind dinosaurs

Another variable in the analysis is the growth of automated manufacturing in the consumer electronics industries. In the near future, Japanese manufacturers may not be able to make things more cheaply than anyone else. Automated factories operate at essentially the same cost anywhere so the area of competition will move to innovative new products.

A small, flexible company able to read the consumer's mind and supply them with the gadgets they need and want at the right time may devastate the slow-moving, half-blind industrial dinosaurs.

Apple is doing exactly the right thing considering the current state of personal computers. IBM is still testing the water, wondering how to appeal to this strange (to them) new market. The fun is just beginning, and users will benefit from a tremendous outpouring of creative energy in new consumer electronics products.



APPLE COMPATIBLE — DUAL PROCESSOR

* CENTRAL CPU, 6502 & Z80a * 64K BYTE OF USER RAM 12k OF ROM * FULLY PROGRAMMABLE KEYBOARD * NUMERIC KEYPAD * SPECIAL FUNCTION KEYS * UPPER AND LOWER CASE FULL ASCII CHARACTERS * 16 COLOUR GRAPHICS * 7 EXPANSION SLOTS FULLY COMPATIBLE WITH APPLE HARDWARE AND SOFTWARE

** 3 MONTHS FULL GUARANTEE AND SERVICE SUPPORT

NOW WITH **NEW KEYBOARD** FULLY COMPATIBLE WITH ALL **WORD PROCESSORS**

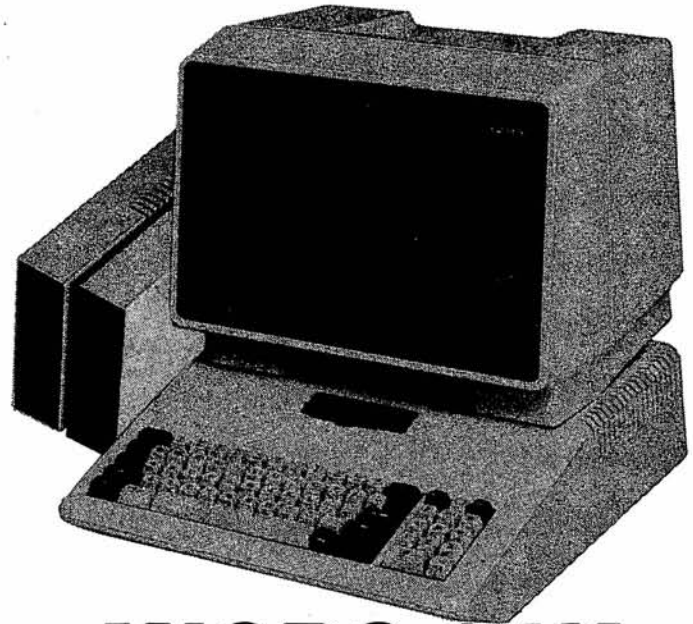

\$669 TAX PAID

**MICRO 64K
6502 & Z80A**

THE AFFORDABLE PLACE TO SHOP

MICRO ~ BUFF

TELEX AA 139718

TELEPHONE 277 7754 (ASK FOR RAY POPE)

**499 HIGH STREET ROAD,
MT WAVERLEY 3150
MELBOURNE, VICTORIA,
AUSTRALIA**

THE TOTAL SYSTEM

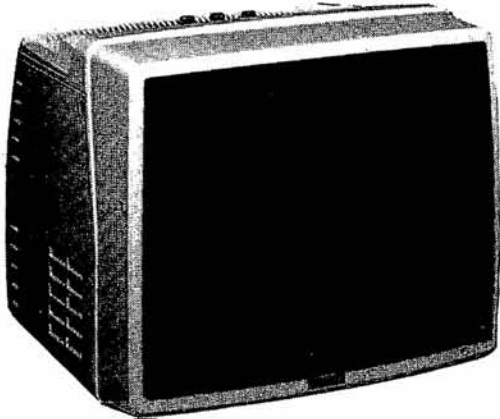

**BMC 18 MHZ
MONITOR
\$279 —**

SAM

THE VOICE
FOR YOUR
COMPUTER

\$39.00 Tax Paid
INCLUDES SOFTWARE

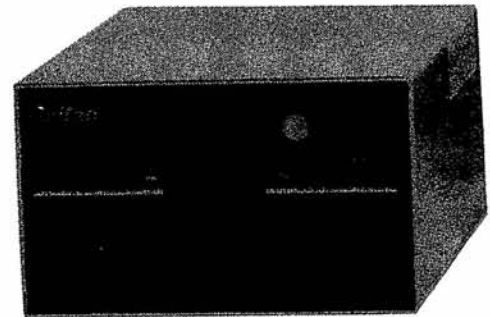

**SHUGART DISK DRIVE
\$320.00**

80 COLUMN INTERFACE CARD VIDEX COMPATIBLE
INCLUDES 40/80 SOFT SWITCH

\$95.00 TAX Paid

VALUE AT \$1497. **THIS MONTH ONLY \$1150 TAX PAID**
SPECIAL SCHOOL DISCOUNTS APPLY INCLUDES SOFTWARE & COMPUTER

stripes (red, blue, green and black) and shifts the ribbon up and down as necessary. Currently being shipped to IBM dealers, the printer sells for \$1995.

One persistent problem with computers is glare and reflections on the screen. This is not a trivial problem because such things lead to headaches and eyestrain. IBM obviously tried to take care of the problem by using the amber screen, and by recessing it so the top and side of the cabinet project over and alongside the screen, shading it from ambient light. Also, the screen has an anti-glare filter on its surface.

Available options

- Slimline Disk Drive \$425
- Colour monitor
- 64/256k memory expansion
- Printer adaptor
- Game control adaptor
- Expansion unit
- Asynchronous communications adaptor
- Binary synchronous communications adaptor
- Graphics printer
- Colour printer \$1,995
- Compact printer
- Cluster adaptor
- 8087 math co-processor

Verdict

IBM has succeeded admirably in producing a portable version of the PC. Maintaining software compatibility among all members of the PC family is an important factor which will make the entire PC range (standard PC, PC/XT, PCjr. Portable PC, and the mainframe-to-PC gateways such as the 3270-PC and XT/370) more attractive to potential users. Because of this, the PC range has acquired a degree of maturity. It now makes sense as a set of related tools.

The Cluster system takes this one step further and integrates all the models at a relatively low cost into a simple network. Now the advantages of a small network are available to PC users who don't have a minicomputer to act as a network controller.

Schools and small businesses should find this network well suited to their applications, and the Portable PC adds an extra measure of flexibility to such an installation.

IBM did not intend, with this round of new product announcements, to answer the challenge of the Apple Macintosh. Neither did it intend to stave off the impending influx of Japanese lap computers. Certainly it has competing machines under development, and will announce them soon. In the meantime, IBM has encouraged third party software developments such as VisiCorp's Vision

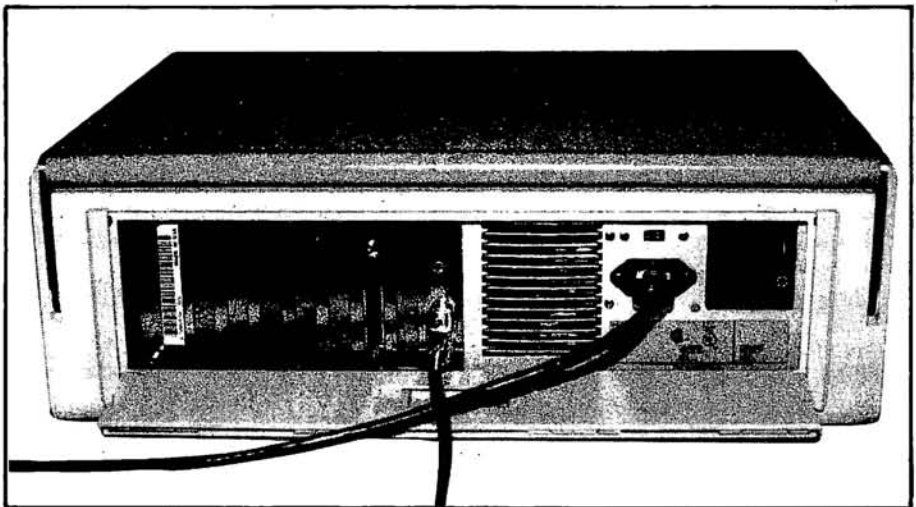

Protected by flip-down panel are printer connector, monitor output and blank panels for future options.

and Microsoft's windows and mouse. These will run on the Portable until IBM's answer to the Macintosh appears.

It is difficult at this stage to know when, or even if, the portable will be

making an appearance in Australia. Experience tells us that its arrival may be many months away; as usual IBM refuses to "speculate" on its own plans.

Specifications

Price	US\$2,795
Processor	Intel 8088 at 4.77MHz. The 8087 high-speed math co-processor is optional.
RAM	256k standard, expandable to 512k
ROM	40k
Text screen	80 characters by 25 lines
Graphics Resolution	same as standard PC
Colour Graphics Capability	Colour/graphics adaptor card included as standard equipment
Keyboard	Full 83 key standard PC keyboard
Storage	Slimline 5¼in disk drive stores 320k under DOS 2.1 on double-sided double-density diskettes. Second disk drive optional.
Operating System	MSDOS
Language	Basic
Expansion Slots	3 full-size, 4 short
Dimensions	20 x 17 x 8 inches
Weight	30lbs

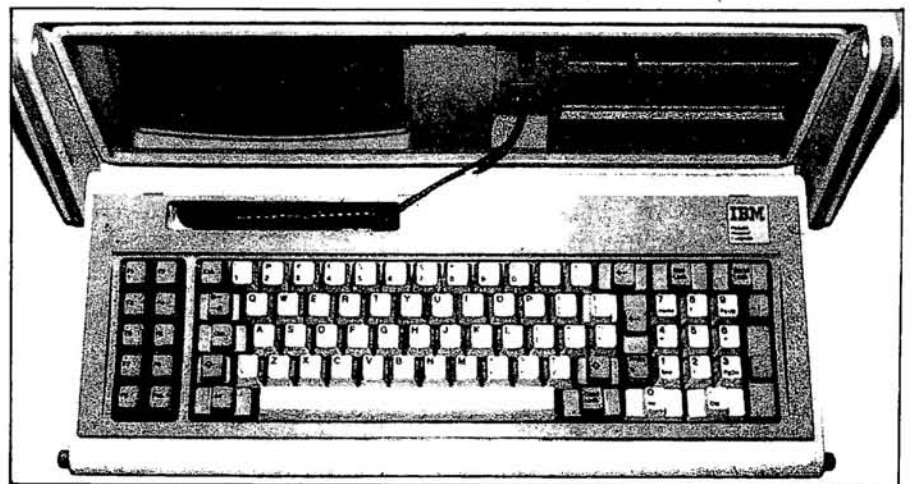

The flip-down keyboard is exactly the same as on the standard PC.

A BEGINNER'S GUIDE TO PROGRAM CONVERSION

TRS-80/System 80

Surya continues his analysis of each machine on the APC Converter Chart (see November 1983 issue). High and low resolution graphics and sound capabilities for the System 80 and TRS-80 Model 100 are featured this month, plus the final part of the Apple II conversion.

The TRS-80 has limited graphics facilities; not surprising when you look at how long the machine has been around. The graphics resolution is 64 x 48, the origin (0,0) being at the top left-hand corner of the screen. Thus:

```
100 Rem: A totally pointless program
110 CLS: Y=0
120 FOR X=0 TO 63 STEP 1.3
130   Y=Y+1
140   SET ((INT(X)),Y)
150 NEXT X
```

draws a line diagonally across the screen.

The graphics statements are SET, RESET and POINT. SET(x,y) lights the block at coordinate (x,y). RESET switches it off again. POINT(x,y) tests the specified point, returning - 1 if it is lit and 0 if it is not.

The TRS-80 also supports a PRINT @ statement. This allows text to be placed at a specified location on the screen. For the purposes of the PRINT @ statement, the top row of the screen is numbered from zero at the left-hand side to 63 at the right. The next line is numbered 64 to 127, and so on to the bottom line, 960 to 1023. To print at the bottom line, for example, you simply PRINT @ 960, thus:

```
100 PRINT @ 960, "This is printed on
the bottom line";
```

The semi-colon at the end of the PRINT statement suppresses the line feed which would otherwise scroll the screen upwards.

The TRS-80 does not support sound as standard.

The System 80

The System 80 is an oriental imitation of the American TRS-80. Unlike most imitations, however, the System 80 is every bit as good as the original. The TRS-80 is slightly fussier about syntax than the System 80, but the two are all but identical. Most Basic programs are interchangeable. In APC's Programs section, the label TRS-80/System 80 is used to describe programs written on either machine.

The TRS-80 Model 100

The TRS-80 Model 100 is Tandy's port-

able micro. The graphics resolution is 239 x 63, and the graphics commands are PSET, PRESET and LINE, PSET and PRESET are exact equivalents of SET and RESET. Considering that LCD screens are not noted for wonderful graphics, the LINE statement is surprisingly powerful.

The format of the statement is LINE (x1,y1)-(x2,y2), a, BF. The statement draws a line from the first coordinates to the second. If a=1, the line is PSET; if 0,

it is PRESET. The additions B and F are optional. If B is included, then a B)ox will be drawn with (x1,y1) as one corner and (x2,y2) as the other. If the F is included, the box will be F)illed — either PSET or PRESET, depending on the value of a.

The model 100 also supports sound (of the beep variety). BEEP beeps. 'SOUND pitch,length' plays the specified note and is similar to most sound statements.

\$500

'INFORMATION BUSINESS MANAGER'

COMPLETE ACCOUNTING PACKAGE
FOR ALL 8 AND 16 BIT MICROS

THIS AUSTRALIAN DEVELOPED PACKAGE INCLUDES:

- * Accounts Payable
- * Accounts Receivable
- * Stock Control
- * Invoicing
- * General Ledger

ALL FULLY INTEGRATED
COMPREHENSIVE MANUAL

DEALER ENQUIRIES WELCOME

ALSO AVAILABLE

- * REAL ESTATE SYSTEM
- * PAYROLL
- * INSURANCE BROKER SYSTEM
- * OTHER CPM SOFTWARE

A&M Computer Solutions

2 PROSPECT HILL ROAD, CAMBERWELL 3124
Telephone: (03) 813 3022

As promised last month, we continue the Apple II guide with high-res graphics and sound.

High resolution graphics (HGR)

The HGR screen is addressed as 280 columns by 192 rows with six colours available. The Apple reserves enough memory for two high resolution screens, these being called by HGR and HGR2 respectively. Four text lines are again reserved by default and can be made available for graphics use by the statement POKE — 16302,0 and reset to text by POKE — 16301,0.

Two POKES which you are likely to find in Apple programs using the HGR mode are:

POKE — 16300,0 to switch from HGR2 .back to HGR

— 16303,0 to switch from graphics to text retaining text-windows and cursor position.

In HGR mode, there are two main graphics statements: HCOLOR and HPLLOT. HCOLOR=x sets the foreground colour to x, defined as:

- 0 black
- 1 green
- 2 violet
- 3 white
- 4 black

- 5 orange
- 6 blue
- 7 white

Although there are eight codes, two are redundant (4 and 7), leaving six effective colours.

HPLLOT is an easy-to-follow statement operating in a similar way to most machines DRAW statements:

HPLLOT x,y lights point (x,y) in the current colour.

HPLLOTx1,y1 TOx2,y2 draws a line from (x1,y1) to (x2,y2). Coordinates can be 'chained', so that the following HPLLOT statement:

HPLLOT 0,0 TO 279,0 TO 279,191 TO 0,191 TO 0,0

draws a rectangle around the edge of the screen. Most basics don't allow this type of chaining, so you'd have to split up each pair of coordinates and DRAW, SET or PLOT each line separately.

HPLLOT TO x,y draws a line from the current cursor position to coordinate (x,y); it carries on from where it last left off.

There are seven other graphics statements in Applesoft HGR mode: DRAW, XDRAW, SCALE, ROT, SHLOAD, BSAVE and BLOAD. These statements concern a feature known as shape tables. Shape tables are too com-

plex to go into in the space available here and, in any case, the information wouldn't be much use to owners of other machines since you will find them all but impossible to duplicate.

Shape tables are a form of sprite, a kind of sophisticated use-definable character. Created by POKEing values into memory, shape tables may be saved to tape or disk for later loading. The scale and orientation of the resultant shapes can be manipulated using the statements mentioned above. Anyhow, unless you are very familiar with both Applesoft and the machine you are translating to, any program making liberal use of DRAW, XDRAW, SCALE, ROT, SHLOAD, BSAVE or BLOAD should be left well alone.

Sound

There are only two ways to produce sound on Apple: PRINT CHR\$(7) and POKEing memory location — 16336. PRINT CHR\$(7) produces a short beep, as with most machines. Producing anything interesting from the noises emitted by POKEing — 16336 is a decidedly frustrating and not over-fruitful task, so this POKE may be safely omitted when converting to other machines.



HOW! MUCH PERFORMANCE DO YOU REALLY NEED? B.V.P. 6400

COMPATIBLE WITH AN
ENORMOUS AMOUNT OF SOFTWARE
AND ACCESSORIES.

64k — 128k OF RAM. 16k OF ROM

**PROVEN POWER !!!
AT A PRICE THAT KEEPS
YOUR BALANCE**

B.V.P.

"THE MICRO COMPUTER SOLUTION"

456 St. Kilda Road,
Melbourne 3004. Telephone: (03) 267 5450



NOW RELEASED

MICRO PRO INTELLIGENT PC-301

The MICRO PRO personal computer PC-301 is a 16 bit computer system designed specifically to be compatible with off-the-shelf software and peripheral cards that conform to the popular IBM personal computer standard.

Each MICRO PRO personal computer consists of:

★★★★MAIN CPU★★★★

- ★ 8088 16 BIT 4.77 Mhz
- ★ room for 8087 mathematic chip
- ★ five expansion slots on main board
- ★ 128k of ram expandable
- ★ disk controller for up to 4 drives

★★★★COLOUR CARD★★★★

- ★ graphics
- ★ 80 column x 25 lines
- ★★ twin 340k disk drives standard
- ★★ detachable key board 95 keys

★MULTIFUNCTION CARD★

- ★ RS 232 communications port
- ★ 128k of ram expandable
- ★ parallel port



★★OPERATING SYSTEM★★

In addition to pre written software packages, MICRO PC-301 provides you with Microsoft MS-DOS so that you can design and write your own custom software (Licenced to run MS DOS)

DEALER ENQUIRIES WELCOME

PC 301 TELEPHONE 03 568-6911
MICRO PRO COMPUTERS
 43 ATHERTON RD, OAKLEIGH 3166 MELB AUST

PLEASE SEND ME MORE INFORMATION

NAME.....
 ADDRESS.....
 SUBURB..... P/CODE.....
 STATE.....

PULSAR WINS PREFERRED SUPPLIER STATUS TO EDUCATION DEPARTMENT

PULSAR ELECTRONICS P/L, THE LARGEST MANUFACTURERS OF STD BUS MICRO COMPUTER SYSTEMS IN AUSTRALIA HAS WON EXCLUSIVE PREFERRED SUPPLIER STATUS TO THE VICTORIAN EDUCATION DEPARTMENT. PULSAR ELECTRONICS MANUFACTURE A RANGE OF COMPUTER EQUIPMENT FROM SINGLE STAND ALONE MACHINES TO 20 USER TURBODOS SYSTEMS. PULSAR, WHO HAVE RECENTLY MOVED INTO LARGER PREMISES AT TULLAMARINE, ALSO MANUFACTURE A RANGE OF ANCILLARY STD BOARDS TO COMPLEMENT THEIR LITTLE BIG BOARD WHICH FORMS THE HEART OF ALL PULSAR SYSTEMS. THESE BOARDS INCLUDE:

256K RAM CARD
 AUTO DIAL/AUTO ANSWER MODEM CARD
 SASI INTERFACE CARD
 SIX CHANNEL SERIAL CARD
 TURBODOS PROCESSOR SLAVE CARD

ALL OF WHICH ARE AVAILABLE AS SEPARATE ITEMS.

PULSAR'S NATIONAL SALES MANAGER (MR JOHN REARDON) WOULD BE PLEASED TO DISCUSS ANY COMPUTER REQUIREMENT THAT SCHOOLS MAY HAVE.

Pulsar Electronics Pty Ltd commenced trading and manufacturing High Technology products in 1980. The original corporate structure was a partnership and included a total staff of two. During 1980/81 various micro-computer based products were developed including computer display signs and a single board computer which was Z80 based. In 1981 a concept to provide a

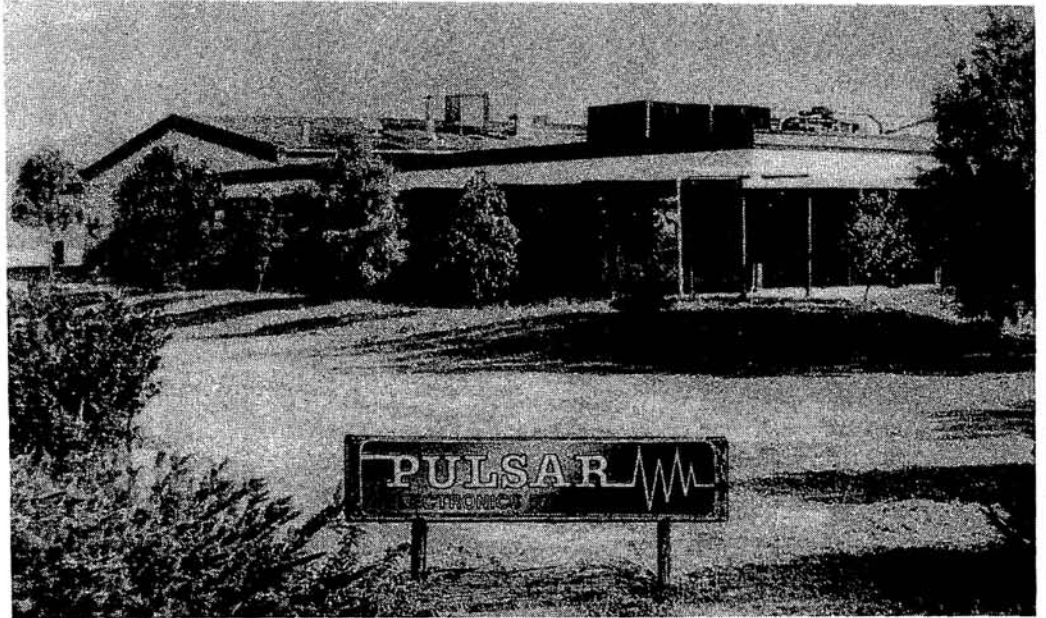

high performance low cost general purpose computer with the maximum expandibility and flexibility was conceived. The product which resulted is known as the Little Big Board. Being the first people in the world to incorporate so much performance on a single STD Card we achieved a significant marketing edge. As the word spread through the industry, both locally and internationally, the sales of Lit-

tle Big Board based products increased to such a level that we currently employ 19 persons. Our organisation is exceptionally young with an average age of 26. As an organisation we have grown with the assistance of those government departments who appreciate the local High Technology excellence of our products. (a) Products are 100% 'open'

with regards to software listing and design. (b) Offer local support and the possibility to expand a system and solve a specialised problem efficiently. (c) All our products are designed for high reliability, performance and low cost. (d) We carry stock not like many others who import to fill orders.

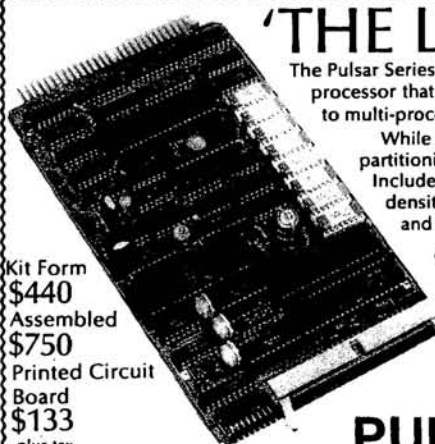

'THE LITTLE BIG BOARD' Assembled or Kit Form

The Pulsar Series 6000 Microcomputer card has been designed to provide a cost-effective general purpose central processor that will find application in a wide range of systems, from stand-alone and dedicated control processors to multi-processing and network configurations.

While the 6000 Series is fully compatible with the industry-standard STD bus, attention has been given to partitioning the circuit so that a complete disc-based computer system can be constructed using just one card. Included on the board is: Z80A processor operating at a full 4 MHz, 64 Kbytes dynamic RAM, single/double density floppy disc controller for up to 4 drives, two RS232C serial I/O ports, 2 Kbytes PROM bootstrap/monitor and battery-backed real-time clock and calendar.

CP/M® DISTRIBUTION PAC

Includes CP/M Version 2.2 with PULSAR's enhanced BIOS implementation; PROM bootstrap and Utility Package.

TECHNICAL MANUAL PAC

- Circuit diagrams of the Little Big Board
- Source Listings of BIOS, loader and bootstrap
- Source Listings of Utility Programmes
- Detailed description of L.B.B. operation

Kit Form \$440
 Assembled \$750
 Printed Circuit Board \$133
 plus tax

PULSAR ELECTRONICS

Lot 2 Melrose Drive Tullamarine 3043
 Tel (03) 330 2555 Telex IMTBM AA10104

C·O·M·M·U·N·I·C·A·T·I·O·N·S



APC welcomes correspondence from its readers but we must warn that it tends to be one way! Address letters to: 'Communications', APC, 77 Glenhuntly Road, Elwood, Victoria 3184.

Lotus 1-2-3

This is to clear up a few of the problems described in your December review of the Lotus 1-2-3, specifically:

1. A display of remaining memory can be obtained through the Worksheet Status command.

2. Printing may be stopped at any time by striking Control-Break. This may also be used to stop printout of graphics. Note, however, that many printers have a buffer of 2k or greater. Therefore, Control-Break will not necessarily stop printing immediately but will stop filling the printer buffer. When the print buffer empties, printing will stop.

Tracey Jewells Lotus Development Corp, US

AID

Using microcomputers for scientific applications in a large company, I am occasionally aware of the temptation to proliferate other people's useful software. Whether proliferation within a company constitutes breach of copyright is part of the current debate on software piracy. For example, what is the practical difference between using software held on another computer via a communications line and using the same software on a copied disk?

A simple idea which

would be highly effective in reducing unauthorised software proliferation is the introduction of the addressable identified (AID) in microcomputer systems. The AID is a unique code fixed in ROM at the microcomputer manufacturing stage. In its simplest form, purchased software packages are modified before despatch to the user, to contain the users AID at several points. The software contains instructions to compare the software and ROM AIDs: where a mismatch is found, the program crashes. The security problem is reduced to hiding the AIDs and disguising references to them within the software.

While such a method will not provide complete protection against a sophisticated pirate, it might at least stop the low level proliferation; that is, several copies for different computers within a small business.

R Brown

Basic loop

In response to A Sheppard's letter (*APC*, February 1984), I would like to point out that there is an easier way to simulate a REPEAT-UNTIL loop in Basic. The method takes advantage of the fact that boolean expressions can be included in assignment statements and will be evaluated as 0 for false and 1 (or -1 in some cases) for

true.

This method, example given here, avoids the 'unbalanced stack' Mr Sheppard referred to:

```
100 REM previous part of
    program
110 REM
120 REM "REPEAT"
130 FOR REPT=0 TO 1
140 REM
150 REM instructions to be
    repeated
160 REM
170 REPT=(condition to
    terminate loop)
180 REM "UNTIL
    (condition)"
190 NEXT REPT
200 REM
210 REM rest of program
220 END
```

If your version of Basic uses -1 to represent true, use 170 REPT= — (condition to terminate loop) instead of the above (and also in nested REPEATS), and so on.

Line 170 sets the loop variable to false (0) so that when the NEXT statement is encountered, the loop will be repeated. When the condition is true (1) the NEXT will cause termination of the loop, and so restore the stack (Mr Sheppard's problem).

By including the statement 125IF (condition to terminate loop) THEN 200, we obtain a simulated WHILE DO . . . ENDDO statement. It should be obvious that with this method, we can construct all the structured formats available (other than procedures) in languages

such as Pascal without resorting to PEEKs and POKEs.

Brendan W.

Criticism

One of the beguiling things about reading *APC* monthly is the acerbic and iconoclastic tone of many of your editorial team, and the feeling that you are beholden to no-one in what you say or how you say it.

After all that, I think that Mike Liardet overstepped the bounds of objectivity in his review of the Commodore 715 in the February '84 issue.

I deduce from his article that he has:

— Never used a Commodore machine before.

— Never looked closely at one either.

— Cannot believe that anything not locked in to 'seepy/M' and its clones is worthy of the name computer.

To start with, a minor point: criticism of the IEEE-488 port being an edge connector — . . . not on a \$2300 one'. Why not? The Osborne 1 has the same setup. Anyway, once the peripherals are plugged in, you don't spend a lot of your time unplugging them regularly, so what's the problem?

'Commodore has had an uneavable reputation for providing poor documentation'.

NEW MODEL!

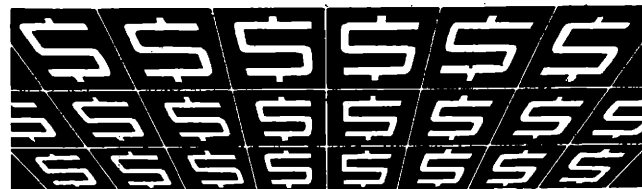

THE PRICE/PERFORMANCE WINNER

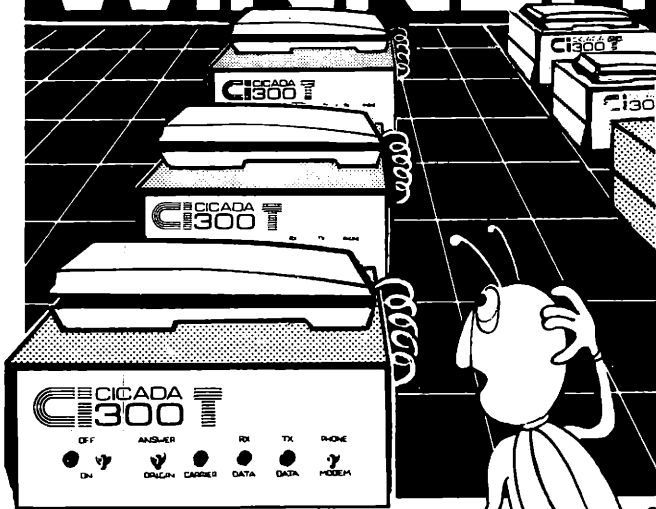

**CICADA
300T**
DATA MODEM
WITH INTEGRATED TELEPHONE

CIC300T01

For user installation to a standard phone socket without Telecom assistance, the new **Cicada 300T 300-Baud data modem** features fully integrated phone for maximum convenience. With all the legendary performance and reliability of the standard Cicada 300:

Or, buy the continuously improved standard Cicada 300 for use with your own telephone. Now operated by hundreds of government, business and private users, the Cicada series modems carry a full, meaningful warranty.

Specifications (Both modems): Compact answer-and-originate units for direct connection to phone lines and for computer interface utilising either RS232C or V24/28 systems. Unit measures 203mm x 152mm x 63.5mm. Telecom approval number C83/37/1011.

Available now from Centre Industries or leading retailers.



187 Allambie Road, Allambie Heights, NSW 2100
Telephone (02) 451 5555 After Hours (02) 451 6244
Telex AA 22671

C·O·M·M·U·N·I·C·A·T·I·O·N·S

Agreed, but that's part of the mystique of using CBM.

He appears to be shocked that nothing had to be booted to get the beast going. Ask the tens of thousands of home micro owners how often they boot their systems from a disk. This, dear Mike, is how micros ought to work. It's only historical accident that the majority of business machines require you to fill one drive semi-permanently with a system disk, instead of having the system tidily stored in ROM where it belongs.

Sneering at the provision of a cassette drive port implies a superiority that takes little account of fact. If you can't afford a hard disk then you can't afford a tape streamer, and the humble cassette offers a cheap and convenient way of taking backups of files and copyable software. Very sensible too:

Now the crunch: 'Commodore . . . has steadfastly refused to adopt any of the standard operating systems, and arrogantly persists with its own.' That 'arrogant' really gets up my nostrils. CBM is a standard among those who use their products. It's a robust and workable OS using clear and (mostly) unambiguous commands. But, most importantly, it does what an OS ought to — it manages the data flow without getting in the way of the primary task of the user, which is to use the machine to enhance his company profitability.

A decent OS will perform its functions while being 1) unobtrusive, and 2) efficient. To borrow some of the review's arrogance, I am not convinced that CP/M manages either. My clients (mostly businessmen) make it abundantly clear to me that what they ask of a machine is something which enhances the running of their work, without requiring hours of study to get it going. Whatever other faults

they have, Commodore machines certainly are in the 'plug in and go' class, needing no complicated setting up or configuration.

I have no connection with Commodore other than as a very satisfied consumer and purchaser of their products for home and office use.

Mr P Gillman



Simmering debate

The debate about the relative merits of various programming languages, particularly between the proponents of Basic and Pascal, simmers on. The truth is that none of the available computer programming languages is perfect. Since discovering CP/M I have made regular use of Basic, Pascal, Fort and Assembler, and am at present learning C. All of these have a use but none is suitable for all the tasks I undertake. For the record, my perfect language would have the following features:

It should be fully interactive. This implies the use of an interpreter or incremental compilation as in Forth. Editing the program should not dump variable contents.

Array sizes should be dynamically allocated at run time. For example, the equivalent of the Basic statement:

10 A=100

20 DIM MATRIX (A)

should be legal. The language should support a full range of structured programming features. In particular, it must be possible to write closed subroutines or procedures to which parameters can be passed. Long variable names should be allowed.

It should have a compiler option which is 100% compatible with the interpreted mode of the language. This

C·O·M·M·U·N·I·C·A·T·I·O·N·S

makes the dynamic allocation of array space difficult but surely not impossible. Bascom fails in this respect.

The language should operate on two levels. It should be possible to write virtually any application using 'normal' programming techniques and, with the language's help, detect type mismatches, and so on. At the same time, advanced users should not be prevented — as they are in Pascal) from taking short cuts and playing clever tricks. Of the languages I have used, Forth and C come closest to having this attribute. Easy linkage to machine code is an essential part of this requirement.

Any offers to develop such a language? The nearest I have seen to this specification so far is Hewlett

Packard Basic as implemented on its scientific micros, but even this lacks a true compiled mode. BBC Basic has many of the desired features but, again, lacks a compatible compiler.

Peter Amey



Superskip sense

It was with dismay that I read "Superskip Security" (APC, January 1984). Certainly confusing the code using John Noad's method would deter any would be pilferers; however it also makes the code unreadable to Mr Noad himself and very time consuming to amend (especially if he has not

thought out an "Unsuper-skip" procedure!). I don't own a micro, but if I did I certainly wouldn't be employing Mr Noad's questionable programming practices. One more small gripe — hard as I looked I still couldn't find those promised Benchmark descriptions in the January issue (perhaps John Noad "Superskipped" them out of the magazine).

W Bain

Sorry about the non-appearance of the Benchmark listings and descriptions. They finally surfaced in the February issue along with a full chart of all machines tested in order of speed. In future, Benchmark listings will also be printed in each issue in Direct Access. — Ed.



Unfair show

Recently I went to a Computer Fair held in a high school near my home in Sydney. I was impressed by the interest of the parents, students, politicians and the mass media. It seemed all were hoping to find out about the computer age. Most I fear came away baffled and bewildered, they saw hundreds of machines beeping like video games in an arcade. As I am computer literate, parents I knew asked me "how do these machines herald the new era of computers and how can I introduce my children to computers?". The way the computer company displayed their wares made it difficult for me to give an answer.

The stands were staffed

MICROCOMPUTER SOFTWARE MADE SIMPLE!

Business software for microcomputers is Padmede's specialty.

For first time users and for those with no need of complex and confusing option oriented programs, Padmede systems are the answer.

Systems that are:—

- Easy to install
- Easy to operate
- Trouble free
- Fully supported.

and provide immediate results

At \$390 per accounting module Padmede represents the best microcomputer software value in Australia today.

Available on all microcomputers that support CP/M and MS/DOS.

Padmede Commercial Systems

26 Ridge Street, North Sydney, 2060.
(02) 923-2899

TRAVERS SOFTWARE SERVICES
262 High Street,
Kew, VIC. 3101.
(03) 862-2644

PROLOGIC PTY. LTD.
38 Montpelier Retreat,
Battery Point, TAS. 7000
(002) 34-6499

CONSULTECH
55 Colin Street,
Perth, W.A. 6005
(09) 322-1295

TOP SELLING AUSTRALIAN COMPUTER

Coming to terms with the future



microbee

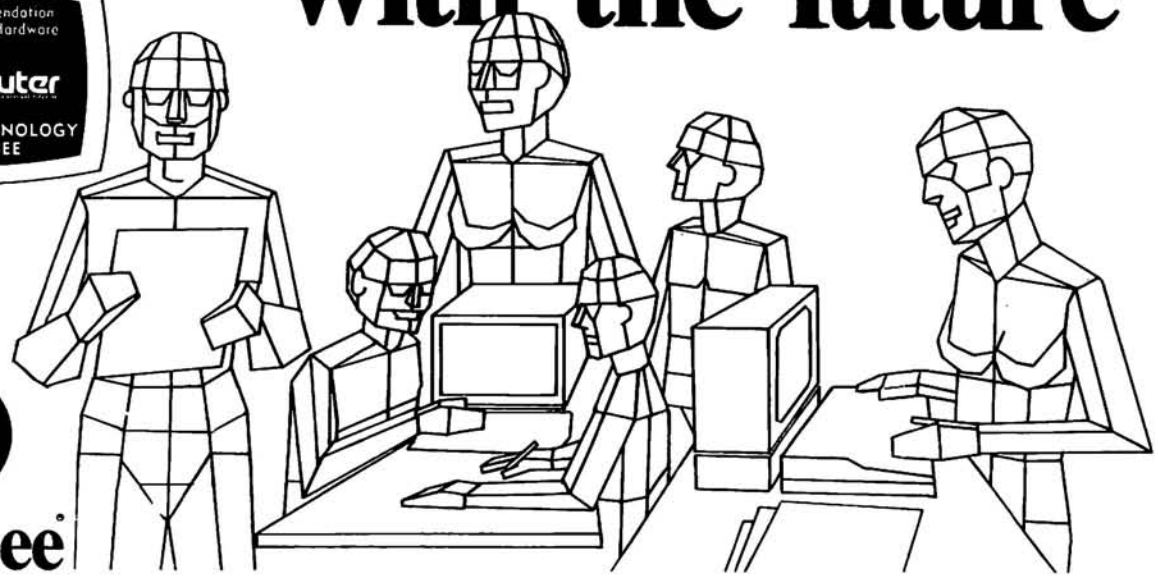

Education

microbee is now officially recognized as Australia's Educational Home Computer. With the release of BEENET 2 it is now possible to NETWORK 16 or more microbees in a classroom with each student station linked to the teacher's file server to produce the ideal classroom system sharing printers, disk drives and rapidly transferring information as required.

Personal Business Use

People don't only want to just use a personal computer. Computers are

for doing something useful in the world. Man uses TOOLS to achieve his goals. microbee recognises this and provides Wordprocessing, Communications, BASIC and a host of utilities inside each unit. In all cases microbee is being used as a TOOL in the service of mankind.

Family Entertainment

Not all applications need to be so serious. microbee is ideal as a basis for exciting and stimulating games for all the family. Fast moving graphics, sound effects and over 200 top quality popular games mean your microbee is ideal for family fun as well.

Why not try your hand at Micro Space Invaders, Robotman, or play Bee Monopoly the 1984 way. Think you know a lot about chess? Try your skills against microbee . . . it can also show how to improve your game . . .

Personal Finance

microbee is a powerful calculator and can be used to improve your personal financial planning, start a data base or even schedule your appointments. microbee is indeed a modern tool for today's times, enabling young and old to come to terms with the future in a constructive, informative and entertaining way.

<p>SERIES 2 EXPERIMENTER</p> <p>By popular request, the low cost microbee Series 2 Experimenter has been designed for those who are starting out in the fascinating world of computers or those who want to share the fascination of exploring the exciting developments in the fast moving MICROWORLD. All microbees can be expanded at any time. microbee Experimenter \$399</p>	<p>SERIES 2 EDUCATOR</p> <p></p> <p>The microbee Series 2 Educator was specifically designed to serve the needs of the education market. This is recognised by the fact that the microbee has been chosen by the NSW, WA, Queensland and the Australian Schools Commission as a recommended computer for use in schools. With the exceptional performance at a realistic price, powerful software designed for Australian curriculum needs, microbee is now in wide use throughout primary, secondary schools, technical colleges and universities. microbee Educator \$449</p>	<p>SERIES 2 ADVANCED PERSONAL COMPUTER</p> <p>The microbee Series 2 APC with 500K Disk Drive is the most powerful and best priced/performance computer in its class. The APC is now supplied 'bundled' with WORDSTAR, MULTIPLAN, microbee BASIC, CP/M 2.2 plus MICROWORLD packages such as disk WORDBEE, EDASM, BASIC as well as vital utilities such as CONFIG, FORMAT, COMPARE. Comprehensive Microworld User Manual also supplied. microbee APC (Single Disk Drive) \$1495 microbee APC (Dual Disk Drive) \$1795</p>
--------------------------------------------------------------------------------------------------------------------------------------------------------------------------------------------------------------------------------------------------------------------------------------------------------------------------------------------------------------------------------------------------------------------	-----------------------------------------------------------------------------------------------------------------------------------------------------------------------------------------------------------------------------------------------------------------------------------------------------------------------------------------------------------------------------------------------------------------------------------------------------------------------------------------------------------------------------------------------------------------------------------------------------------------------------------------------------------------------------------------------------	-----------------------------------------------------------------------------------------------------------------------------------------------------------------------------------------------------------------------------------------------------------------------------------------------------------------------------------------------------------------------------------------------------------------------------------------------------------------------------------------------------------------------------------------------------------------------

The Solution: microbee Personal Communicator

Our top selling portable **microbee**, the Personal Communicator now features Telcom1 firmware, WORDBEE, Microworld BASIC, machine code MONITOR, ADM-3A terminal emulation, self-test in 28K of ROM with 32K of CMOS battery backed user memory, high resolution PCG GRAPHICS, SERIAL AND PARALLEL I/O ports, programmable cassette interface, and direct monochrome video output.

Add the low cost BEEMODEM and your Personal Communicator uses the home telephone line to become a complete home terminal ready, willing and able to communicate with other computers worldwide.

Microworld BASIC has long been a powerful feature of the **microbee**. A vast library of educational, entertainment and utility software is now widely available on the market. Microworld BASIC supports full high resolution graphics, colour if required, music, I/O data can be directed at will and, best of all, MW BASIC is a breeze to learn to program yourself.

microbee
Personal Communicator . . . \$499



microbee computer centres

1 Pattison Ave,
Waitara 2077.
Phone (02) 487 2711

729 Glenferrie Rd,
Hawthorn 3122.
Phone (03) 819 5288

141 Stirling Highway,
Nedlands, Perth.
Phone (09) 386 8250

Coleman Court,
Weston A.C.T. 2611.
Phone (062) 88 6384

151 Unley Road, Unley.
S.A. 5061. (08) 272 1384

455 Logan Road,
Stones Corner,
Qld 4120

Koala Crescent,
West Gosford 2250.
(043) 24 2711

Authorised Dealers in:-

NSW: Carlingford,
Coffs Harbour, Concord,
Hurstville, Lismore,
Sydney, Waterloo,
Wauchope

VICTORIA:
Glen Waverley,
Melbourne.

QUEENSLAND:
Aitkenvale, Cairns,
Milton.

SOUTH AUSTRALIA:
Adelaide, Edwardstown,
Port Lincoln.

WESTERN AUSTRALIA:
Mount Tom Price.

TASMANIA:
Launceston
ACT:
Belconnen, Weston.

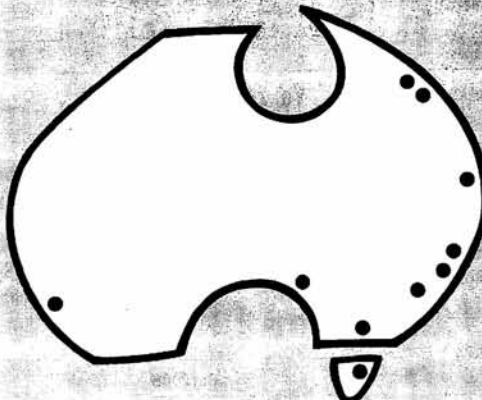

**Shops and Dealers
Australia wide**

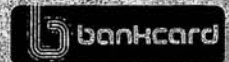

DIRECT ORDERS
PHONE (02) 487 2711
TELEX AA72767

**APPLIED
TECHNOLOGY
RETAIL PTY LTD**



microbee

MELBOURNE HOUSE keeping up with COMMODORE

Commodore 64 Games Book

Teach your Commodore 64 every trick in the book. 30 programs ranging from nerve shattering space games such as Galaxy Raid and Earth Defence, to real life adventures including Sea Harrier and Flight Simulator. You can enter them all yourself by simply following the easy to enter listings.
"For a Commodore 64 games enthusiast this book is a must." — Personal Computer News



Commodore 64 Exposed

The definitive book for the Commodore owner. A complete and comprehensive guide that clearly explains every function of your Commodore 64, from BASIC to machine language. The book goes far beyond the data provided in the Commodore user's guide. It includes full details on advanced programming, graphics and sound, plus simple demonstration programs that can be entered in minutes.

VIC Innovative Computing

Packed with exciting arcade, strategy and adventure games, these 30 easy to enter programs open a whole new dimension in computer game excitement.
"If you were to ask me which books I would buy, I would take VIC Innovative Computing."
— Practical Computing

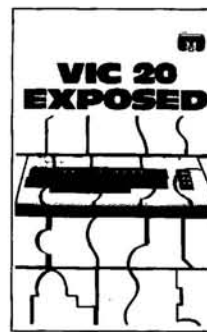

VIC 20 Exposed

First time computer owners or experienced programmers — get more out of your VIC 20. Understand all the facilities of your micro and get the maximum potential out of your programs. "VIC 20 Exposed" lets you understand exactly how this versatile home computer works, from BASIC right through to machine language — all in simple, straightforward language.

Commodore 64 The Hobbit

Visit J.R.R. Tolkien's Middle Earth with The Hobbit — the most amazing adventure yet devised.
"A game by which future games will be judged."
— Personal Computing Today.
"The most powerful computer game yet invented."
— Computer Weekly.
"Superior to any other adventure game."
— Your Computer.

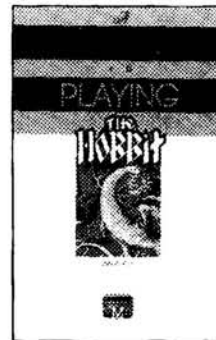

A Guide To Playing The Hobbit

Finally! A guide to playing the most exciting and challenging adventure today, The Hobbit. Whilst providing solutions to the problems which are encountered, this book aims to preserve as far as possible the qualities of challenge and discovery which are so much a part of The Hobbit. No two games are alike, and this guide will help you to discover more about The Hobbit each time you play.

Commodore 64

- Commodore 64 Games Book \$19.95
- Commodore 64 Exposed \$19.95
- Commodore 64 The Hobbit \$39.95

VIC 20

- A Guide To Playing The Hobbit \$9.95
- VIC Innovative Computing \$17.95
- VIC 20 Exposed \$19.95

APCA

DEALER ENQUIRIES WELCOME

I enclose my cheque/money order for \$

Please debit my Bankcard No.

Expiry Date

Signature

Name

Address

Postcode

\$	
\$	+ p/p \$2.00
Total	
\$	

Please add \$2.00 for post and pack.

MELBOURNE HOUSE

Suite 4, 75 Palmerston Crescent, South Melbourne, 3205. Telephone: (03) 690 5336



C·O·M·M·U·N·I·C·A·T·I·O·N·S

by representatives who seemed familiar with business systems or essentially arcade type game machines. Some reps were honest enough to say "I only have business machines". Most others tried to bluff their way. They succeeded in confusing people, not enlightening them.

There was little education software. This is what people had come to see. Mostly the software was of GeeWhiz programs or the plug in arcade type. These programs do not impress concerned parents. After much searching I came to one stand, in the furthest classroom devoted to education software. The only such stand at the Fair! I spoke at length to the sales person. He lamented the lack of interest in good educational

software. Of all the sales persons, he seemed the only one with any concept of how computers can help in education. Unfortunately, the margins he said were not available in selling software, especially as there is no copyright law in Australia at present. Just as people would soon lose interest in record players if there were not a readily available supply of good records, so they will if the imbalance between software and hardware is not quickly corrected.

I suggest that in future school computer fairs, companies should use school children to demonstrate what their machines and software can do; not business or arcade games sales persons. This would give credibility that the sales representatives at this fair

mostly did not display. As students are cheaper to employ, more could be on hand to demonstrate on an individual basis. This would also give the computer students an introduction to the real world of computers.

Also the organisers of Computer Fairs should make sure the emphasis is on software, not hardware. Companies should be given incentives, most likely financial, to display useful programs and not just hardware running inappropriate software.

If Computer Fairs continue to confuse parents as this one did, I feel that the public will rapidly lose their fascination for computers.

D Butler

Bug answered

In the December issue of TJ's Workshop Tim Hodges wrote in wondering why the program in chapter 18 (of the Spectrum manual) was being upset by pressing CAPS-SHIFT 5 a few times.

There is a fairly simple explanation for this occurrence: CAPS-SHIFT 5 is read as CHR\$(8). This is a standard ASCII code for cursor left. To demonstrate what happens when you PRINT CHR\$(8) type in this program.

```
10 PRINT AT 0,0;"hello  
   there 123456";  
   CHR$(8);CHR$(8);
```

```
15 PAUSE 40  
20 PRINT "XxX"
```

You can see that PRINTING CHR\$(8) moves the PRINT position one to the left.

In Tim Hodges program

**Thinking
about
your
IBM PC/XT**

Want one or have one?
Need to talk to experienced
people who understand
your business?

Looking for application software?
Want to NETWORK your systems?
Need training on LOTUS, dBASE 2, PC DOS?
You should be talking to us.

**THINK
COMPUTERS**

602 Maroondah Hwy, Mitcham, 3132
Phone: (03) 873 1122

PLEASE SEND FURTHER INFORMATION **IBM PC/XT**
NAME
COMPANY NAME
ADDRESS
PHONE

TANDY ELECTRONICS DEALER

DISCOUNTS ON ALL TANDY COMPUTERS AND ACCESSORIES

Free delivery throughout Australia.
90 day Warranty
Bankcard & cheque orders accepted.

Bayne & Trembath

3 Boneo Rd., Rosebud, Vic 3940
Ph: (059) 86-8288, A/H (059) 85-4947
(TANDY DEALER 9320)

C·O·M·M·U·N·I·C·A·T·I·O·N·S

```
10 IF INKEY$ <>" "
   THEN GOTO 10
20 IF INKEY$ = " "
   THEN GOTO 20
30 PRINT INKEY$
40 GOTO 10
```

When you press CAPS-SHIFT 5 the program PRINTs CHR\$(8), moving the print position off the screen! This sometimes makes a mess of the display file, which in turn affects everything in RAM, including the program.

T Richardson



Sexist 1

As a woman and leasee of an Apple IIe I do object to the cover of your magazine December 1983. Could I remind you that sex and women's bodies are not

needed to sell computers. While I agree that both are fascinating we women, and I hope you men also, do not use our computers to assist our sex lives. (Computer dating aside.) I would hope that in future your magazine will celebrate women's intelligence rather than display our bodies.

Eileen Willis



Sexist 2

I wish to lodge a complaint about the cover of the December issue of *Australian Personal Computer*. I find it offensive that you have used women's bodies (no faces, mind you) to sell your product and I consider that it reflects

poorly on you and your magazine.

The computer industry is at present dominated by men and I believe women should be encouraged to the industry. This kind of advertising can only serve to alienate women. It undermines the intelligence and competence of women working with computers by relating women's bodies and no other attributes to computers. (By the way, how do you consider women's bodies and computers relate?)

By assuming a sexist male readership you make another mistake. This year Australia's Businesswoman of the Year was a woman working in the computer industry and you will do well to remember that there are many women, and men too, in the industry and using computers in the

home, who find this kind of advertising distasteful.

Fiona Hardie



A nice pair

As a regular subscriber to APC, I must congratulate you on the front cover of the December issue. The design showed a most delightful pair (of computers) in fine detail. I hope you will continue with a similar "do it anywhere" theme on future covers and perhaps offer the two sales representatives a further opportunity to display their merchandise in future issues of the magazine. Well done APC!

S Langford



SOFTWARE RENTAL

NOW YOU CAN RENT THE MOST POPULAR GAMES — EDUCATIONAL — BUSINESS SOFTWARE FROM:



At only 20%-25% of the current retail price + Postage & Packing

- All software in original manufacturers packaging.
 - No minimum quantity.
 - Rentals are for 7 days (plus 3 days grace for return shipping).
- We will endeavour to obtain any software requested.

To immediately order, or for more information ring:

S. D. COMPUTER RESEARCH

1/4 SOUTH STREET, EDGECLIFF 2027
Telephone: (02) 328-6293

COMMODORE 64

SOFTWARE FANTASTIC OFFER!

12 PROGRAMMES FOR \$10.00

• GAMES • UTILITIES • APPLICATIONS

THATS RIGHT . . . 12 COMMODORE 64 programmes on cassette for only TEN DOLLARS!!! That's about half the amount that you'll expect to pay for just one programme.

WHAT AN OPENING OFFER!!!!

PLUS You'll regularly receive details of all the fantastic new software and hardware available from dozens of overseas sources at tremendous discount prices.

Free Post No 4. G.S. WEBBER & ASSOCIATES: P.O. Box 238, Gympie, 2227. No stamp required. Please send ONE CBM64 multtape to:

Name

Address

..... P/Code

I enclose \$10 as full payment by Cheque P/Order

Bankcard No.

Expiry Date Signature

"Almost everything about MultiMate® is new and miles ahead of the competition."

Designed to emulate a Wang dedicated word processor, MultiMate demonstrates the same elegance, functionality and versatility."

PC World © August 1983.



Professional word processing used to be available—on expensive, dedicated systems. Only giant corporations could afford them. Then, they had to buy the necessary training and talent to keep them running.

We invite you to try MultiMate Word Processing for the IBM PC** and most plug-compatibles. MultiMate transforms the PC into a dedicated word processor.

Skeptical? Don't buy it, just try it.

Then you'll see why, without our even saying a word, MultiMate is for you . . . for your company.

Who can use MultiMate?

You can! If you're a novice to word processing, MultiMate won't be any harder to use than the typewriter or yellow pad you're using now. If you're an expert, you'll find MultiMate extraordinarily powerful. (Think of MultiMate as a software package that lets you seek your own level.)

Stand-alone utilities

File Conversion Utilities allow you to convert standard ASCII files to MultiMate documents and vice versa. That means you can read and use files created on other word processing equipment, too.

EDITPAT (Edit Printer Action Table) allows you to customize the MultiMate program to make best use of your individual printer configuration.

Document Recovery allows you to correct problems in some documents caused by improper removal of document diskettes—for example, lost data or missing format lines.

Unsurpassed support

At Software Corporation of Australia, we've built our reputation on providing prompt, useful support to registered end-users. Our Customer Hotline has enabled MultiMate users to get answers to their questions when they need them most: right away!

Why is MultiMate better?

It's more than just a superior word processing program. Compare for yourself. Unlike other distributors, our user and dealer support is unlimited. We upgrade our registered end-users for 5 years for a guaranteed upgrade charge; ask to see our SCA Customer Support Plan for details. And in a user's manual that reviewers call the best in the industry, we've got tutorials, a reference section, index, glossary and much more.

Even spells words the Australian way!

MultiMate's latest version — called 3.21 — comes complete with an 83,000 word spelling dictionary which adopts Australian/British rather than American spelling form.

Distributed in Australia exclusively by

**SCA SOFTWARE CORPORATION
OF AUSTRALIA PTY. LTD.,**

449 Swanston Street, Melbourne, 3000.
Telephone (03) 347 7011. Telex AA30458.

**MULTIMATE
INTEGRATES
PERFECTLY WITH
DATA BASE
MANAGER II FOR
SORT & SEARCH
CAPABILITIES**

MultiMate functions are key-driven

Here's your chance to really read between the lines. In this list of MultiMate's functions, one thing stands out—the power of MultiMate. What you won't see is how easy MultiMate is to use. We've consolidated keystrokes and commands, which means fewer keystrokes. And that means more efficiency, less learning time.

CURSOR POSITIONING FUNCTIONS

- up cursor position
- down cursor position
- right cursor position
- left cursor position
- back tab
- end of screen
- end of page
- go to page number
- go to place mark
- go to tab
- home
- next page
- next word
- page down
- page up
- previous page
- previous word
- set place mark
- scroll cursor left
- scroll cursor right
- search
- top of page

EDITING FUNCTIONS

- auto page numbering
- auto underline—alphanumeric
- auto underline—text
- case significant search
- center
- character insert
- character delete
- copy
- decimal tab
- delete
- document merge
- escape
- external copy
- footers
- hard space
- headers
- hyphen (soft)
- indent
- insert
- move
- page break
- page combine
- page length
- repaginate
- replace
- required page break
- return
- save
- save/exit
- search
- stop print
- strikeover
- subscript
- superscript
- underline characters
- tab
- word wrap

FORMATTING FUNCTIONS

- format—change
- format—current
- format—delete
- format—page
- format—system
- format line—replace
- format line set-up
- status line

PRINTING FUNCTIONS

- background print
- bold print
- draft print
- enhanced print
- foreground print
- merge print
- printer control codes
- right justification
- shadow print
- stop print
- variable print pitch
- 30 item print queue

ADVANCED FUNCTIONS

- column calculations: horizontal addition
- column calculations: vertical addition
- column manipulation—copy
- column manipulation—delete
- column manipulation—insert
- column manipulation—move
- key procedures—create
- key procedures—execute
- key procedures—pause
- key procedures—prompt
- library
- library attachment
- merge code
- spell—check
- spell—edit

SUPPORTING FUNCTIONS

- highlight—character
- highlight—cursor position
- highlight—line
- highlight—sentence
- highlight—word
- highlight—paragraph
- on-line help screens
- on-screen shift status indicators

UTILITIES

- edit drive defaults
- edit printer defaults
- edit system format line
- print document summary screen
- print queue control
- rename a document
- search document summary screen
- copy a document
- delete a document
- move a document

Productivity tools for Australian business.

*MultiMate is a trademark of SoftWord Systems, Inc. **IBM PC is a registered trademark of IBM Corporation.

\$75 Million

1,400%

IF YOU THINK IBM IS THE ONLY GAME IN TOWN, WE'RE GOING TO THROW YOU A CURVE.

Whenever we hear claims that IBM is destined to be the sole survivor in a personal computer marketplace supposedly littered with dying independents, it reminds us of Mark Twain's comment about the reports of his demise being greatly exaggerated.

There is life after IBM.

While there is no denying IBM's stature in the industry, to think they're the only game in town simply doesn't compute. Just look at your own sales curve.

In the past fiscal year, Kaypro sales grew 1,400%. In fact, we are now the fourth largest seller of personal business computers in America (after IBM, Apple and Tandy). Thereis, it would seem, life after IBM.

Our success is hardly a fluke, given our 30 years of electronics manufacturing experience. Nor is the strength of our diverse product line unique. We can point to dozens of independent computer companies with equally strong barometers of success.

And therein lies the critical issue. For, though pleased with our own success and the continued vitality of the industry as a whole, we are concerned that all the predictions of an eventual IBM stranglehold on the market might create something of a self-fulfilling prophecy. As a business publication noted recently, many industry analysts believe that the media-fueled IBM mania has had a harmful effect upon the industry, discouraging investor and consumer confidence in companies whose successes warrant that confidence.

Capitalizing on this unjustified fear, IBM urges consumers to huddle under the security of its Big Blue umbrella. Only then does the customer discover that IBM is selling the very guts of a personal computer system as expensive add-on "extras" — things like software to make the computer useful, two disk drives to store information, or a screen to view the work being done. By the time a full IBM system is assembled, the buyer has usually paid about twice what a comparably equipped all-in-one Kaypro would cost.

IBM is certainly free to market their machines as they please. But it does make us wonder what might happen to the downward trend in computer prices if IBM — "the only company able to overcharge," as one newspaper reporter not afraid to draw attention to this issue recently put it—were to gain the vise-grip on the market that some people fear.

Some industry analysts also fear that the IBM juggernaut threatens the innovative drive and technological momentum that made America's personal computer industry what it is today. After all, IBM did not invent the personal computer. It merely used its marketing power to push its way into a new industry that had already been created by smaller, more innovative firms. As a recent commentary in the industry's magazine of record, InfoWorld, put it: "The record shows that IBM consistently stood in the way of progress, while all innovation came from startups."

"At Kaypro, we don't think any one company can monopolize the personal computer business, and our own sales figures prove the point. But we're also not blind to the attractive power of the IBM logo. That's why we'll always go them one or two steps better by providing much more computer at much less cost.

To show what we mean, we'll soon announce a startling new incentive to encourage consumers to evaluate our computers up close. There is an alternative to IBM. Watch for us.

KAYPRO

Sincerely

David G. Kay
VICE PRESIDENT,
MARKETING AND PRODUCT PLANNING

 **president** COMPUTER GROUP. AUSTRALIAN DISTRIBUTORS OF KAYPRO WITH THOUSANDS OF AUSTRALIAN USERS.

SYDNEY MELBOURNE ACT WA OLD SA TAS NT
(02) 476 2700 (03) 529 1788 (062) 88 2000 (09) 384 5511 (07) 397 0888 (08) 260 2444 (003) 31 8388 (089) 81 5905

\$5 Million

The more you think IBM,[®] the more you like Columbia.

Only Columbia gives you true IBM compatibility
and over \$3500 worth of software with every computer.

Columbia VP Portable



Columbia MPC
Hard Disc Desktop

Columbia MPC Dual
Floppy Disc Desktop

Nobody gives you more IBM-PC compatibility for your money than Columbia. Hardware add-ons and peripherals—all compatible. And all the popular software packages the IBM runs, Columbia runs.

Choose from a number of operating systems including MS-DOS, CP/M-86, and others. Plus service you can count on nationwide from PRESIDENT. And of course quality that has met the most demanding standards for fourteen years.

Columbia offers three very professional personals. The VP Portable, with up to 640K bytes of main memory and two 360K byte floppy disc drives. The MCP 1600-1, with main memory up to 640K bytes, two 360K byte floppy disc drives, two RS232 serial ports, one IBM compatible parallel printer port, and eight IBM compatible expansion slots. Or the MCP 1600-4, with an

added 10M byte formatted hard disc for increased storage and disk access speed.

You couldn't ask for more. But you get more.

Columbia adds value like nobody else in the industry. Buy any Columbia and get sixteen standard software packages worth over \$3500. Perfect Writer, Perfect Filer, Perfect Calc, Perfect Speller, Data Communications, Fast Graphs, Home Accountant Plus, Columbia Tutor, two operating systems (MS-DOS and CP/M-86) and the new T.I.M. IV Data Base Management System. And others. And just for fun, Space Commanders. All that software would cost you more than the computer itself. No wonder so many people come in with IBM on their minds, and walk out with Columbia in their hands.

COLUMBIA

DATA PRODUCTS, INC.

Get Columbia performance and value now. From just \$3940
(PLUS TAX)

Available only where you see this sign  **president**

SYDNEY MELBOURNE BRISBANE ACT PERTH ADELAIDE
(02) 476 2700 - (03) 529 1788 - (07) 229 0019 - (062) 88 2000 - (09) 328 6522 - (08) 260 2444

MICROMAIL

Personal and Pro



MTX512:64k RAM
MTX500:32k RAM

Distributed By MICROMAIL (02) 449 5600 (02) 467 1933

essional



Dealer enquiries welcome

The All-Purpose System

The MTX Series is a new departure in micro-computer technology. Whether your needs as a user are for personal programming, games playing, scientific or process control, educational or business use the MTX Series is already capable or very easily adaptable to almost every application. Glance through the standard features below - you'll see what we mean.

Hardware - 32K RAM on the MTX500, 64K on the MTX512.

The MTX500 has 32K of user RAM as standard (64K on the 512), expandable to 512K plus 16K of video RAM, controlled by a separate Video Processor. Sixteen colours, 40 column text, 256 x 192 high resolution graphics with all sixteen colours available, and 32 easily moveable user defined graphics characters (Sprites) combine to make effective screen displays quick and simple to achieve. Standard outputs are centronics printer port, two joystick ports, an uncommitted I/O port, 2400 Baud Cassette port, separate TV and Video Monitor ports, 4 channel sound with hifi output plus a dedicated cartridge port. Other standard features include the Z80A processor running at 4MHz, real time clock, full moving key keyboard with 79 keys including eight 2-function keys and separate numeric pad.

Software

The MTX's 24K ROM contains several languages and routines which enable the novice or the experienced programmer to make full use of the machine. Standard languages are MTX BASIC, MTX LOGO commands, NODDY. ROM routines include an ASSEMBLER/DISASSEMBLER with screen display of the Z80 CPU registers, memory and program, which can be manipulated from the keyboard. Machine code programs can be stepped through one instruction at a time, and easily called from within BASIC programs. A further feature is the Virtual Screen facility which enables the programmer to split the screen into a maximum of eight sections to work independently whilst maintaining all full screen facilities. Pascal is available as an add-on ROM pack.

The Disc Based Computers from Memotech

Designed to use the full power of the MTX computers the FDX and HDX make perfect business systems at prices which make perfect business sense. Both feature the CP/M operating system, giving instant access to a wide range of proven application software.

Available in October these feature:

- Full Western Digital floppy disc controller set with SASI interface for 4 drives, CP/M types 0-13.
- minimal latency, very high data transfer rates
- optional Colour 80 Column Board
- optional Silicon Discs (1/4 Mb) which dramatically increase the efficiency of 8 bit software to those of 16/32 bit software; increases life and reliability of mechanical drive
- permits single disc CP/M operation

FDX— Floppy Disc System

1 or 2 5 1/4" Qume drives 500K unformatted, 347K formatted,

HDX— Hard Disc System

5 1/4" Qume drive, 500K unformatted, 347K formatted,
5 1/4" Winchester which may be 5, 10, or 20 Mb

All Memotech products are designed and manufactured in Oxfordshire, England

CP/M is a trademark of Digital Research Inc.

MEMOTECH
MTX
SERIES

OSBORNE

Osborne Executive Productivity

In 1981, Osborne Computer Corporation created the concept of portable, low-cost personal business computing. Quite simply, it was a revolutionary change in the way people go to work.

Today, tens of thousands of business professionals who now use the Osborne 1 have found these tools easy to use and fun to learn. And literally indispensable.

The same innovative approach to business computing has created The Executive by Osborne.

The Executive was designed, built and priced with one objective: to increase your productivity. It is a tool to help you move ahead quickly in your business or profession **now**.

The Executive is delivered with the hardware and software tools you need to go to work right away on the jobs you do for hours every day. With enhanced hardware and software, the Executive is designed to make the Osborne concept of personal business computing even more attractive.

It's the next logical step.

The evolution of the Osborne revolution.

Your Osborne Executive is an investment in your business future

It's an investment in your own scarcest resource: thinking time. It lets you put the time you save on mundane chores into creative, "bottom line" tasks.

It's an investment in your personal growth, because The Executive gives you new tools to do new jobs, jobs you simply could not imagine doing before.

And it's an investment in your effectiveness, because the Executive handles all the details for accurate computations, error-free typing and organisation of dates, facts and lists.

Do you work with words?

With WordStar,[™] The Executive becomes a simple and powerful portable word processor. It lets even two fingered typists get their ideas down faster than handwriting or dictation. Best of all, it is quick and painless to change your mind and improve what you've written, to change your strategy to meet market conditions.

At the same time, your secretary is freed to do more useful "assistant" work, while you achieve polished, finished text with total control and privacy.

Letters, memos, reports, articles, copy, ideas — will improve dramatically. They'll take less of your time and minimise interruptions. They'll go out faster. Your time becomes more effective, you become more efficient.

Do you know the BASICs . . .

Two powerful BASIC dialects — MBASIC[™] and CBASIC[™] come with the Executive. If you have studied a little programming, you'll know the power of these two languages. If you haven't, you may find them useful for business application software and a wide variety of learning programs that will introduce you or your children to the fundamental power of the computer.

Do you work with numbers?

The Executive and SuperCalc[™] replace your calculator, paper and pencil with the accuracy and unflinching attention of a speedy, dedicated machine.

Remember the last schedule, forecast or budget you did by hand? Now imagine laying it out without having to add any numbers across or down. Think how fast you could work if changes made in one month's allocation were reflected instantly across the entire spreadsheet.

That's what the Executive can do with SuperCalc[™]. It works just as easily on a single column of figures, a complex budget forecast, trend analysis or research report.

Everything you do with numbers can be saved on a diskette for later review or revision. Or it can be run out on your office printer.

Do you want to get organised?

The Executive includes Personal Pearl,[™] a powerful database manager. Using your Executive, you can now file, organise and find all sorts of information. Quickly. Easily. All you do is enter the quotes, name and address lists, market data, or whatever, by filling in simple forms on the screen. Forms you specify yourself.

The Executive will sort it all out and store it in a way that lets you find it the first time you look. Fingertip efficiency that is infallible.

It's a personal electronic filing system, address book and calendar pad all wrapped up in one. You can instantly get your hands on facts that used to be jumbled up in a file somewhere. And you need never again call a phone number that's been changed. Change it once and it's instantly changed everywhere in your own personal database.

Lots of memory to work with

The Executive has 128K of user memory, making it extremely quick, a useful attribute when you're working with number-oriented tasks or sorting through data files. Expanded memory also lets you add more rows and columns to your spreadsheets than ever before — extending the range and power of the SuperCalc[™] program considerably. The two disk drives store 200K each, which means you can have about 60 typed pages of word and number information at your command on a single disk.

EXECUTIVE™

\$3600 Software worth
Limited Offer
all included in price

Terminal Emulation (optional)

Most large companies have vast stores of information full of facts that would be useful to the executive . . . if you could only reach them.

The Osborne Executive lets you plug into your company's computer system. In many cases your Executive can function with your main computer just like one of its own terminals.

Say hello to the information age!

The most exciting development in personal business computing is the telephone. The Executive COMM-PAC™ option lets you plug your Executive right into the telephone.* To let you access and control information electronically. Now you can enjoy instant access to an even wider world of information . . . latest stock listings, news reports, newspaper clipping files, commercial research services . . . the list grows daily.

And you can begin saving time and money with electronic mail. You can exchange files and information with other Osbornes – even other computers – over the telephone lines. Just imagine the advantage of sending a twenty page document anywhere in the world in a matter of minutes!

*Subject to Telecom approval

Newest and best operating systems

The systems that manage computer operations are continually being improved. The Executive includes two different operating systems: CP/M Plus, a new and easier-to-

use version of CP/M; and the UCSD p-System, which has recently become an industry standard.

What this means to users is that a vast library of applications tools designed to run with CP/M or p-System computers is available to you. CP/M and p-System software from Osborne and a number of other sources can help you accomplish almost any business task you can imagine.

The bottom line

If quill pens were the state of the art and someone showed you a ballpoint, would you learn how to use one? If letter-writing was the way business was done and someone told you about the telephone, would you investigate it? If typists and filing cabinets and mounting postage bills are the bane of your bottom line and someone told you about an inexpensive investment that could set you free to do what you do best, would you check it out?

Your Executive productivity investment goes where you go

Because the Executive is portable, you never need to work without it. And you'll quickly find you don't want to work without it.

AUTHORISED OSBORNE DEALERS

NEW SOUTH WALES

Complete Solutions, SYDNEY
(02) 331 6799
Computer Connection, MIRANDA
(02) 526 1404
Computers Galore, NEUTRAL BAY
(02) 908 2355
Computer Spectrum, WOLLONGONG
(042) 271 666
Data Parts, ALBURY
(060) 218 080
Delta, BANKSTOWN
(02) 705 6636
Direct Computer Sales, HURSTVILLE
(02) 570 8344
Grace Bros Computer Centre, SYDNEY
(02) 238 9111
Orana Cash Registers, DUBBO
(068) 825 833
S.C.C. Computing, SYDNEY
(02) 290 3344
Typewriter City Discounts, SYDNEY
(02) 267 8847

AUSTRALIAN CAPITAL TERRITORY

Boulevard Business Services, CANBERRA
(062) 485 411
R.C. Electronics, CANBERRA
(062) 547 608

QUEENSLAND

Archive Computer Centre, CLAYFIELD
(07) 262 2911
Cairns Computer Centre, CAIRNS
(070) 518 010
Compsoft, SPRING HILL
(07) 229 0066
Computers & Peripherals, KEDRON
(07) 350 2611
Electronic Warehouse, FORTITUDE VALLEY
(07) 528 455
Myer Computer Centre, INDOOROOPILLY
(07) 378 5111
Scarborough Fair Computers, SOUTHPORT
(075) 325 133
Toowoomba Computer Centre, TOOWOOMBA
(076) 327 542
The Byte Shop, NEWMARKET
(07) 352 6621

Town & Country Computers, TOWNSVILLE
(077) 754 000

SOUTH AUSTRALIA

Micro-80 Computing Centre, ADELAIDE
(08) 211 7244
Myer Computer Centre, ADELAIDE
(08) 217 0123
The Copy Centre, WHYALLA
(086) 457 755

VICTORIA

Almer Distributors, OAKLEIGH
(03) 569 0169 or 569 6911
Data Parts Pty Ltd, ALBURY
(060) 218 080
Data Parts Pty Ltd, SHEPPARTON
(058) 217 155
Data Parts Pty Ltd, BENDIGO
(054) 434 866
Data Parts Pty Ltd, BALLARAT
(053) 313 399
Direct Data, Armadale
(03) 206 949
Geelong Computing Centre, GEELOG
(052) 222 844

IMA Computer Centre, SURREY HILLS
(03) 560 2974

WESTERN AUSTRALIA

Amity Computers, ALBANY
(098) 416 060, 413 792
Computer Country, PERTH
(09) 328 4644
Merton Scott Business Machines, PERTH
(09) 328 6522
Myer Computer Centre, PERTH
(09) 321 0151
Ossie Computers, CLAREMONT
(09) 384 5511

NORTHERN TERRITORY

Davioics, ALICE SPRINGS
(089) 523 517
The Computer Shop, DARWIN
(089) 814 893, 812 712

TASMANIA

Strawberry Enterprises, BERRIEDALE
(002) 491 814

MAKE AN EXHIBITION OF YOURSELF..

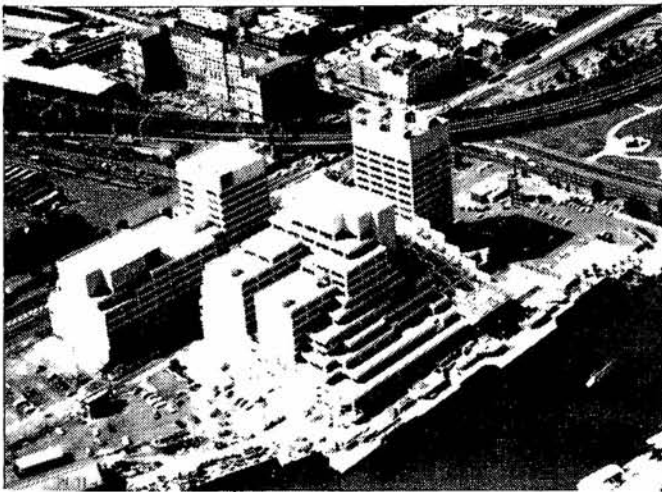

Where? At The 3rd Australian Personal Computer Show World Trade Centre Melbourne.

This will be the first time you have the opportunity to participate in the largest specialised microcomputer show in Melbourne.

Four days provides you with more selling time and more time to be a part of the current microcomputer revolution.

With many of the largest computer companies already participating the benefit of securing your place in this show is obvious.

Discount admission to special interest groups, free admission to the trade and \$4 admission to the public. Free seminars and free catalogues for all visitors.

Phone Fleur Michael now to secure the best possible choice of sites and your place in the future of the microcomputer industry.

Organised by Australian Exhibition Services Pty Ltd in association with the London based Andry Montgomery group, the largest specialist exhibition organiser in the world.

Further details:

AES Australian Exhibition Services Pty Ltd
3/2 Illoura Plaza 424 St Kilda Road Melbourne Vic 3004
Telephone (03) 267 4500 Telex 39329
SPONSORED BY AUSTRALIAN PERSONAL COMPUTER



The 3rd Australian
Personal
Computer Show

World Trade Centre
Melbourne
18-21 July 1984

Bring a micro

David Hopkins describes his Sharp PC1500 program which acts as a computer scoreboard for well-known games such as Scrabble.

I took my (S)harp to the party... but nobody asked me to play, or so runs the old ballad that used to be sung to while away long evenings. Let's face it though, a harp is a liability in many social gatherings and *glissandos* are not everyone's delight. Bring your 'desktop' micro to the party, complete with peripherals, and you are likely to get the same treatment as was handed out to our Victorian minstrel: 'Boot' has more than one meaning.

The ever-shrinking and more capable breed of portable or even pocket micros, though, may be much more socially acceptable. Take the Sharp PC series, for example: you can even slip them discreetly into your inside pocket if your host or hostess purses a lip at the very hint of a byte. However, if the micro is actually going to be accepted into the party, it must be able to sing for its supper, just like our turn-of-the-century baritone.

The trouble is that with their limited display capabilities (a penalty for their very portability) our socialising micros are not very communicative. With ingenuity and the judicious use of limited memory, user-friendliness can be achieved or, should we say, sociability.

The program given below allows scoring on games such as 'Scrabble' was written for the Sharp PC1500, a machine that, complete with interface/printer, is smaller than many a fashionable coffee-table book. The one line LCD display is used almost solely to prompt inputs, while the fascinating printer-plotter (which on its own generates enough interest to keep the party going) is used to yield a continuously updated record of the state-of-play and to deliver a table of results at the close.

With all these features included the 8k memory extension is essential, but you could drop some features and eliminate REMS, and so accommodate a truncated version within the standard machine. Adapting the program to other machines is straightforward as long as you take account of the steps used to circumvent the limited print formatting capability of the PC1500.

The program first asks you to input the name of the game, the number of players (up to four players are allowed, but 'Solo' is declared illegal) and their names in order of play. A variable

duration turn-timer option is offered. On completion of this preliminary procedure, the printer then delivers a heading which automatically includes the date and time of starting and formats a number of columns according to the number of players (see Fig 1).

Scores are then requested by the LCD display for each player in turn, so no-one will ever again need to ask 'Who's next?'. Scores are limited to three digits for the same reason that the number of players is limited to four — lack of space on the narrow cash-register type of paper roll. The program utilises the second size of character, 'C-SIZE 1', in the interests of legibility, but if you can tolerate the minuscule 'C-SIZE 0' then four-digit scores, or

```

10:"A":REM INPUT
   NAMES
30:REM Enter 999
   to end scoring
40:CLEAR :Y=1983
50:DIM N$(3):M1:
   DIM U(3):DIM T
   (3):DIM H(3)
60:INPUT "TYPE OF
   GAME ?";A$
70:INPUT "No. of
   Players (2,3 or
   4)";JA
80:IF A<2CLS :
   GOSUB 1300
90:IF A<2PAUSE "S
   OLO NOT LEGAL
   !":GOTO 70
100:IF A>4CLS :
   GOSUB 1300
110:IF A>4PAUSE "T
   OO MANY PLAYER
   S !":GOTO 70
120:FOR J=0TO A-1
130:PAUSE "PLAYER
   No. ";J+1:INPUT
   N$(J)
140:L=LEN N$(J):IF
   L>10GOSUB 1300
   :PAUSE "Shorte
   n Name Please"
   :GOTO 130
150:NEXT J
160:REM **FORMAT*
170:CLS :LPRINT "G
   AME OF ";A$
180:LPRINT "PLAYED
   BETWEEN"
190:LPRINT "1. ";N$(
   0)
200:LPRINT "2. ";N$(
   1)
210:IF A=2THEN 120
220:LPRINT "3. ";N$(
   2)
230:IF A=3THEN 120
240:LPRINT "4. ";N$(
   3):GOTO 1200
250:LPRINT TAB 5;"
   1";TAB 13;"2";
   GOTO 280
260:LPRINT TAB 3;"
   1";TAB 10;"2";
   TAB 16;"3";
   TAB 18;"4"
270:LPRINT TAB 2;"
   1";TAB 7;"2";
   TAB 12;"3";TAB
   16;"4"
280:LPRINT "-----
   -----"
290:INPUT "TIMER W
   ANTED ? (YorN)
   ";D$
300:IF D$(("<"Y"")THEN
   340
310:INPUT "No. of m
   inutes per tur
   n ?";JB
320:REM **SCORING*
330:IF D$(="Y")GOSUB
   1400
340:INPUT "1st. Pla
   yers Score ?";
   S:IF S=999GOTO
   550
350:T(0)=T(0)+S:IF
   S>H(0)LET H(0)
   =S
360:IF A=3GRAPH :
   LPRINT USING "
   #####";T(0):
   TEXT :GOTO 390
370:IF A=4GRAPH :
   LPRINT USING "
   #####";T(0):
   TEXT :GOTO 390
380:GRAPH :LPRINT
   USING "#####
   ";T(0):TEXT
390:IF D$(="Y")GOSUB
   1400
400:INPUT "2nd. Pla
   yers Score ?";
   S:IF S=999LF 1
   :GOTO 550
410:T(1)=T(1)+S:IF
   S>H(1)LET H(1)
   =S
420:IF A=3GRAPH :
   LPRINT USING "
   #####";T(1):
   TEXT :GOTO 4
   50
430:IF A=4GRAPH :
   LPRINT USING "
   #####";T(1):
   TEXT :GOTO 4
   50
440:GRAPH :LPRINT
   USING "#####
   ";T(1):TEXT
450:IF D$(="Y")GOSUB
   1400
460:INPUT "3rd. Pla
   yers Score ?";
   S:IF S=999LF 1
   :GOTO 550
470:T(2)=T(2)+S:IF
   S>H(2)LET H(2)
   =S
480:IF A=3LPRINT T
   (2):GOTO 330
490:GRAPH :LPRINT
   USING "#####
   ";T(2):
   TEXT
500:IF D$(="Y")GOSUB
   1400
510:INPUT "4th. Pla
   yers Score ?";
   S:IF S=999LF 1
   :GOTO 550
520:T(3)=T(3)+S:IF
   S>H(3)LET H(3)
   =S
530:LPRINT T(3):
   GOTO 330
540:REM **SORTING*
550:U(0)=T(0):U(1)
   =T(1):U(2)=T(2)
   :U(3)=T(3)
560:CLS :LF J
570:FOR J=0TO A-2
580:FOR J=J+1TO A-
   J
590:IF T(J)>T(J+1)
   THEN 610
600:O=T(J):T(J)=T
   (J+1):T(J+1)=O
610:NEXT J
620:NEXT J
630:REM **RESULTS*
700:FOR J=0TO A-1
710:LPRINT T(J)
720:NEXT J
730:LF -A:X=0:W=0
740:FOR J=0TO A-1
750:IF T(0)=U(J)
   LPRINT "1st. ";
   N$(1):X=X+1
760:NEXT J
770:IF X=ATHEN 900
780:IF X=A-4THEN 8
   10
790:X=X+A-2
800:ON XGOTO 810,8
   10,870,870,930
810:FOR J=0TO A-1
820:IF T(J)=U(J)
   LPRINT "2nd. ";
   N$(1):W=W+1
830:NEXT J
840:IF W=A-4THEN 8
   10
850:W=W+A-2
860:ON WGOTO 960,8
   70,960,930,960
870:X=0
880:FOR J=0TO A-1
890:IF T(2)=U(J)
   LPRINT "3rd. ";
   N$(1):X=X+1
900:NEXT J
910:X=X+A-4
920:ON XGOTO 960,9
   30,960
930:FOR J=0TO A-1
940:IF T(3)=U(J)
   LPRINT "4th. ";
   N$(1)
950:NEXT J
960:T=(T(1)):IF T(0)
   =T(1)LET T=T(2)
   :IF T(0)=T(2)
   LET T=T(3)
970:LF J:LPRINT "W
   INNING MARGIN:
   -";T(0)-T
   (1):T(0)-T
   (2):T(0)-T
   (3)
980:LPRINT "BEST S
   CORES:-"
990:FOR J=0TO A-1
1000:LPRINT USING
   "#####";
   T(J)
1010:NEXT J
1020:T$=STR$ TIME
   :IF TIME <99
   999LET T$="0
   "+T$
1030:US=MID$(T$,5,
   5)
1040:USING "
   LPRINT "FINI
   SHED AT: ";J+1
   :LPRINT "-----
   -----"
1050:LPRINT "====
   =====
   ==":LF 3
1060:GOSUB 1300
1080:INPUT "AGAIN
   -SAME DETAIL
   S?(YorN)";E$
1110:IF E$(("<"Y"")
   END
1120:FOR J=0TO A-
   J
1130:H(J)=0:T(J)=
   0:W=0:X=0
1140:NEXT J
1150:GOTO 1230
1200:REM **DATE**
1210:T1=TIME :T2=
   INT (T1/1000)
   STATUS 1
   0:T3=INT (T
   1/100)-(T2*1
   00)
1220:LPRINT "ON";
   USING "###";
   T3:"/";USING
   "###";T2:"/"
   ;USING "###
   ";Y
1230:FS=STR$ TIME
   :IF TIME <99
   999LET FS="0
   "+T$
1240:US=MID$(T$,5,
   5)
1250:LPRINT "STAR
   TING AT ";J+1
   :LPRINT "-----
   -----"
1270:ON AGOTO 80,
   250,260,270
1300:REM BLEEPER*
1310:FOR K=1TO 5
1320:BEEP 1,50,20
   0:BEEP 1,100,
   200
1330:NEXT K
1340:RETURN
1400:REM **TIMER*
1410:WAIT 0
1420:PRINT "SPACE
   to Start,
   0 to Stop"
1430:M=0:W=0
1440:B$=""
1450:B$=INKEY$
1460:IF B$(("<"
   ")THEN 1440
1470:BEEP 1
1480:O=TIME :F=
   INT (O/100):
   O=(O-F*100)*
   10000
1490:E=TIME :G=
   INT (E/100):
   E=(E-G*100)*
   10000
1500:IF D=ETHEN 1
   490
1510:N=INT (M/60)
   :O=M-(N*60)
1520:M=M-1
1530:PRINT "Count
   down";USING
   "###";N;"min
   s. ";USING "N
   #";O;"secs."
1540:IF (M/10)-
   INT (M/10)=0
   BEEP 1
1550:IF M<20BEEP
   1
1560:IF M=0CLS :
   GOSUB 1300
1570:IF M=0THEN 1
   630
1580:D=E
1590:CS="0"
1600:CS=INKEY$
1610:IF CS("<"0"
   ")THEN 1490
1620:BEEP 1
1630:RETURN
   STATUS 0
   6802
   STATUS 1
   3161

```

Fig 1 Program for Sharp PC1500 Scrabble scoring

PRESENTING – EASY DESK

THE LOW COST MOBILE COMPUTER DESK

A quality product at a price you can afford

- ★ Made in AUSTRALIA
- ★ Easy assembly
- ★ For use in the home, office, at work or in the class room. (IDEAL GIFT!!)

- ★ Packed in cardboard box
- ★ Laminated in teak
- ★ Sturdy steel construction
- ★ Solid castors
- ★ Courier delivers to your door
- ★ Dealers' enquiries welcome

SIZE:
Width 900mm
Depth of top shelf 300mm
Depth of bottom shelf 400mm
Height of bottom shelf 670mm
Peripherals NOT included

Cheques, Bankcard, Money orders payable to:



\$99
Tax paid

HOME COMPUTERS

160 MAIN ROAD (BURWOOD HWY) UPPER FERNTREE GULLY 3156 Telephone: 758 2124

Name
Address State Postcode
Bankcard Signature
 Cheque enclosed Bankcard

SPECTRAVIDEO 318/328



EXTENDED MICROSOFT BASIC
EXPANDABLE RAM, CPM etc.

WE KNOW COMPUTERS

CALCUTRONIC PTY LTD

CALCULATOR AND COMPUTER CENTRE

797 GLENFERRIE ROAD,
HAWTHORN, VIC 3122
Telephone: (03) 818 6631

PARENTS! TOP — RATED SOFTWARE!



DAY BREAK SOFTWARE

FROM MICRO NATIONWIDE

Now you can choose from a variety of the most wanted programs-TUTORIALS, EDUCATIONAL GAMES, DISCOVERY ACTIVITIES, and more . . . all from MICRO NATIONWIDE PTY LTD. PRODUCERS OF FINE EDUCATIONAL PROGRAMMES. MICRO NATIONWIDE'S NEW DAYBREAK division offers superior programs designed for children of various ages and abilities . . . at home!

- The programs are *all self-directing*.
- No adult supervision is necessary.
- Tutorial programs are *all self-correcting*
- Programs are *all self-motivating*

All programs are level-adjustable. Parent or child can vary their complexity and create new challenges as the child progresses.

The Programs Your Child Needs Most!

AGE	TITLE, ORDER NO. and DESCRIPTION	PRICE
3-5	DISCOVER! (DB-2000) — Directionality, colors, body parts with "spirits." Cue cards allow child to work independently. (not available on TRS-80).	37.95
7 & up	PERPLEXITY (DB-3000) — Classic puzzles challenge problem solving, logic and organisational skills. Several levels of difficulty.	37.95
7 & up	MATH BASEBALL (DB-4000) — Builds basic math skills. Several levels of difficulty.	37.95
10 & up	REGIONS of the US (DB-5000) — Game-like program teaches major cities, land forms, products, and climates.	39.95
TUTORIALS	9 & up ADDITION AND SUBTRACTION OF WHOLE NUMBERS (DB-4030)	37.95
	9 & up MULTIPLICATION AND DIVISION OF WHOLE NUMBERS (DB-4031)	37.95
	9 & up ADDITION AND SUBTRACTION OF FRACTIONS (DB-4032)	37.95
10 & up	MULTIPLICATION AND DIVISION OF FRACTIONS (DB-4033)	37.95
12 to Adult	SIMPLE ALGEBRAIC EQUATIONS (DB-4055) — 3 programs of progressively difficult levels.	39.95
12 to Adult	ANNAM (DB-5035) — A simulation in which you are the leader of a developing country. The fate of your small nation lies in your leadership and your ability to remain in control.	\$44.95

Programs available on Apple II or Iie, TRS-80, Commodore 64 Atari 800. When ordering, please specify computer model.

To order write or telephone, send cheque money order or charge to Bankcard, American Express, Visa or Diners Club. Include card number, expiration date and signature. Dealer Enquiries Welcome.

To order or to send for our free catalogue write to: FREEPOST 2,

Micro Nationwide Pty Ltd,
PO Box 653,
Mona Vale, NSW, 2103,

Or telephone (02) 99-1772 (02) 997-3317.





Pat the Postman

Really original. All Pat has to do is collect parcels whilst avoiding obstacles - like cars, fires, trains, etc. Skill level and Hall of Fame.

48K Spectrum.



Deffendar

Earth is under attack from mutant aliens in an accurate implementation of a top arcade game - and one of the most difficult to survive in!

48K Spectrum.

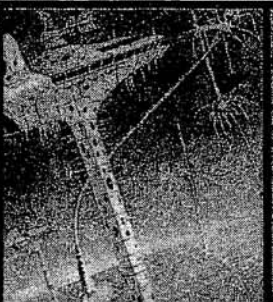

Cruise Attack

Save the city from annihilation in this wonderful version of an arcade favourite. Nine skill levels, bonus points for attack ships.

48K Spectrum.



Nanas

Catch the bananas, miss the coconuts. Easy? Try it and see. Simple in concept, hilariously entertaining - it'll drive you bananas.

16K Spectrum.

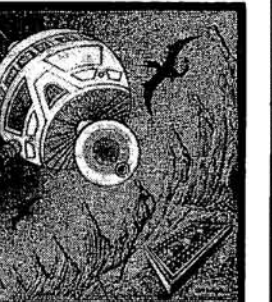

Timequest

A warp-space accident spreads your capsule across time. As you land in each new era, fresh perils face you. A very skillful graphic adventure

48K Spectrum.

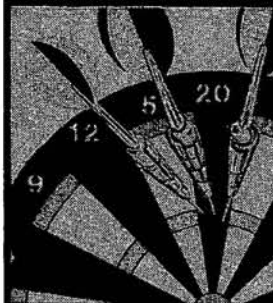

One Hundred & Eighty

That famous shout tells you what it's all about! A good implementation of a difficult game - doubles, trebles, twenty-five and bull all possible.

48K Spectrum.



Land of Sagan

A quest to find the long lost Staff of Health. Is it in one of the castles? Or in the Tower? There are plenty of problems - and plenty of opponents - in this great graphic adventure.

48K Spectrum.

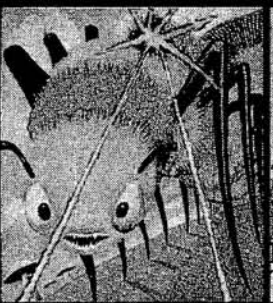

Creepy Crawler

An authentic version of one of the most addictive arcade games devised. All the usual features (Centipede, Spider, Bug, etc) with full use of Spectrum graphics and sound.

16K Spectrum.



Mad Martha II

Great sequel to the best-selling Mad Martha. Hilarious graphic adventure, with hero Henry in sunny Spain, beset by wacky waiters, mad bulls and the wrathful Martha.

48K Spectrum.



SAS Assault

Your mission - rescue the Russian ambassador from terrorist kidnapers, before the Kremlin declares war. Loads in two parts - your rating in the second depends on your skill in the first.

48K Spectrum.

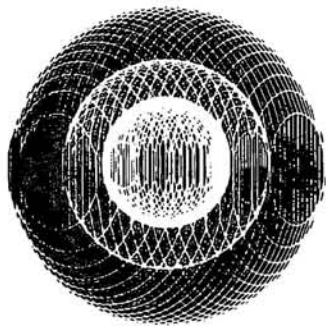

SOFTWARE SPECIALISTS

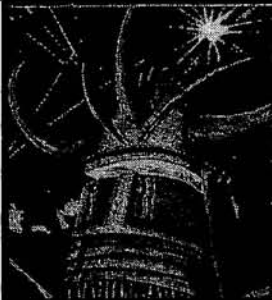

Laserwarp

Invaders. Aliens. this game has the lot - and you have to survive to destroy the Master! Simple controls, far from simple task.

48K Spectrum.

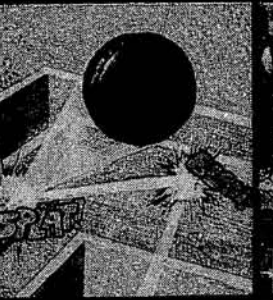

Knockout

No aliens, lasers, invaders or rockets - just simple but absorbing fun which up to 4 players can enjoy.

48K Spectrum.

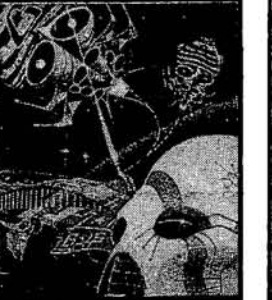

Galakzions

Watch out as the Galakzions break formation to attack in such force that no mere human can survive!

16K Spectrum

SOFTWARE CONCEPTS

P.O. BOX 315, MATRAVILLE, 2036. SYDNEY AUSTRALIA

PHONE: (02) 661 6184

SEGA SC3000 - VZ200 - COMM 64 - VIC 20 - BBC 'B' - SPECTRUM

TIME FOR A SPECTRUM GAMES INSPECTION

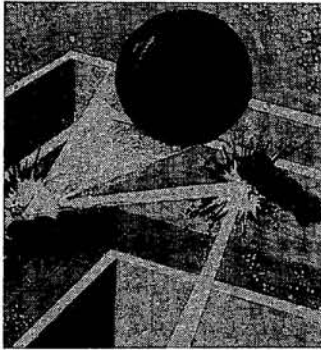

KNOCKOUT FOR 48K ZX SPECTRUM Memory required: 48K Language: Machine code

Knockout is a game in which you compete against the Spectrum or up to three other players, and is effectively a computer version of the popular board game 'Rebound'.

The object is to bounce balls around a board and leave them within firmly defined scoring positions. Each player has four balls to a frame and opponents take it in turns to play each ball of the frame.

The screen display shows a plan view of the board with black walls bent in the shape of a tight G, the ball being shot from the top right end of the G, rebounding off the end walls and ending up in the tall of the G where there are two blue areas of scoring and three green higher scoring areas before a yellow out of bounds.

The player's ball (up to four different colours) is positioned vertically for its shot, an angle determined, and a strength of shot by on-screen prompts and the cursor keys 6 and 7. The balls all remain in play until the frame is completed so there is the chance of knocking an opponent's ball, or your own, into better or worse positions for scoring. Players enter their games at the start of play and the computer scores for each and keeps a running total. If you are on your own and only enter one name, then you will be playing against the computer.

'You might think from the title that this is a 'Breakout' type of game — but it's not, more a new breed of computer bowls, the sort they have in pubs. I liked it very much, why, I don't really know! But it's a very simple game to play and suitable for all ages and all types. It's dif-

ficult to say how addictive people might find it, but at a guess I would say very. It's also good that you can play by yourself or with others.'

'The game is played in-frames up to a maximum of nine, and is a good conversion of a floor or board game to the screen. The game is quite good to play, although not very addictive because the true game calls for physical skill in placing shots, but the fact that it's different places it above average.'

'There's nothing spectacular about *Knockout*. The graphics are essentially simple, but everything is elegantly planned and implemented. Of all sports simulations I've seen recently, I think this is the most appealing and a worthy addition to anyone's collection'.

COMMENTS

Control keys: all done with prompts and keys 6 & 7, & Y.
Colour: effectively plain and to the point.

Graphics: simple, ball rebounds are very good.

Sound: good

Features: against computer or up to 3 other players

General rating: an excellent simulation, difficult to define addictivity properly, but good value generally.



MASTER CHESS FOR 48K ZX SPECTRUM

Ten levels of play + change sides or level in midgame + set board to any position + scrolling history of moves + copy display and history to printer at any time + save game at any point + recognises all legal moves + indicates illegal moves + Chess clock on screen + 6000 move opening book. 'I have seen other chess

games for computers... this is the best so far and should give hours of fun.'

Chess-players with a 48K Spectrum will find this program ideal if they are stuck for a partner. With levels of competence ranging from 0 to 9, both novice and expert will be guaranteed a good game.

You can choose the colour of the board, the pieces and the background to suit yourself, although I found the display quite easy on the eye as it was. Other options include setting up the board — marvellous for problems — requesting the computer to suggest a move, and saving a game.

At level 0 the game is very fast, getting progressively slower as you approach level 9, which as far as I'm concerned is championship chess.

I have seen other chess games for computers, but as far as I am concerned, this is the best so far, and should give hours of enjoyment to the chess buff. **B.B.**

instructions	95%
playability	100%
graphics	75%
value for money	100%

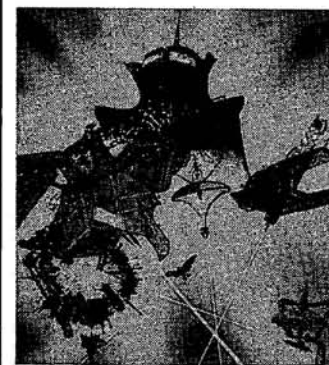

LASERWARP

Memory required: 48K
Language: Machine code

Mikrogen claim that this game has it all. It certainly has quite a lot anyway! It is a very simple shoot em up which has you in control of a laser base while every known electronic alien in the universe is falling on you, swooping at you and hurling indestructible missiles of all shapes and sizes at you. 'Paranoia' might be a more apt title!

The various aliens (depends on the level of play chosen) each have different movement characteristics and drop different types of missiles, including very mean, red-coloured heat seeking missiles which veer towards the laser base as they get lower, following slightly as it moves away.

Surviving ten attack waves leaves you facing 'The Master' who sounds like a nasty piece of work. Should you destroy him, he returns stronger than ever. The universe was never an easy place...

'The game works quite well as a shoot em up, and I like the idea of many aliens on screen at one time. The downward scrolling star background works nicely too, and in general the graphics are good. It has well used colours.

'A very busy screen which keeps you constantly on your toes. Strong graphics and plenty of them, reasonable sound and a very lively shoot em up. Two oddities though, the inlay says user-definable keys, and I couldn't find any, and the game hardly requires them anyway. Also the instructions on the screen say N/L = Fire, when actually it's ENTER. Still, a very good game with a straightforward appeal.'

'Laserwarp is the latest and greatest shoot em up game. It's highly addictive and fun to play. This may even challenge Imagine's *Arcadia* as the best ever Spectrum shoot em up. Extremely good value for money if you like arcade games. Only one niggle — laser base fires rather slowly.'

COMMENTS

Control keys: S/D Left/right, ENTER = fire

Joystick: none

Keyboard play: responsive, but laser can only have one shot on screen at a time

Colour: varied and reasonable

Graphics: very good

Sound: good

Skill levels: 5

Lives: 3

Screens: 10 waves plus master

General rating: very good

Use of computer 88%

Graphics 85%

Playability 78%

Getting started 50%

Addictive qualities 80%

Value for money 80%

Overall 77%



SORCERER'S CASTLE For 48K SPECTRUM

The traditionalist with appreciate *Sorcerer's Castle*. The player may make the choice of becoming, for the duration, a warrior, wizard, elf, Hobbit and so on. Several points are then dished out for strength, wisdom, intellect, etc — the good old traditional Dungeons and Dragons Parameters.

A few more points are given to the player to be distributed as he wishes. Then 60 gold pieces are used to purchase weapons, armour and flares or torches (and you will certainly need some source of light when play starts).

A lengthy wait follows, while the floor plan of the castle is set up — a nice feature of this being the clock that counts down the seconds. It's good to know that the computer hasn't packed up on you!

When the set-up is finished, the player is given information of his whereabouts in the castle. The castle has several levels, each containing 64 rooms (a square of 8x8). A list of weapons and treasure is also available. Now things really start to get interesting! It is possible, of course, to simply thrash about in the dark going from room to room.

But the cautious, or prudent, adventurer will have provided him (or her) self with a torch, or more extravagantly, as they can only be used once, a flare. By shining the light into the next room, the player can safely examine what awaits. In this way the whole matrix can be mapped out. A floor plan can be called up, but will only show the contents of rooms visited.

Whilst travelling about, various treasures and objects are discovered. These are sometimes booby-trapped for the unwary. A book may be a vital clue, or it may blow up in the adventurer's face — or stick to the weapon hand! However, there are many gems lying about for the taking.

The purpose of this weird wandering is to find the Sorcerer and beard him in his LAIR! He is resident in one room of the castle, and many clues are presented to the searcher during the course of his wandering. Whilst the books may be booby-trapped, it is often worth taking the risk to open them, as they may also give the location of the Sorcerer's room.

Now, there are several features of the game, such as the method of travel between levels, and a special extra-fast way of travelling, that I won't detail here — I don't want to give everything away! The program is really a blood relative of that old favourite *Wumpus*, but doesn't suffer because of that. If you are a renegade from *D&D*ing, looking for some of the flavour of that game, *Sorcerer's Castle* is well worth a look.

TIME FOR A VZ200 SOFTWARE INSPECTION LATEST RELEASES FROM SOFTWARE CONCEPTS

ENTERTAINMENT

DEFENCE PENETRATOR	16K	\$12.50
VENTURE	16K	\$14.95
ALERT	16K	\$14.95
PURSUIT	16K	\$14.95
CONQUEST	16K	\$19.95
CRUSADER	16K	\$19.95
STAR STRIKE	16K	\$14.95
ALIEN	16K	\$14.95

BUSINESS & UTILITY

MAIL IT	16K	\$12.50
DISASSEMBLER	16K	\$19.95

EDUCATIONAL

SPELLING TUTOR 1 & 2	8K	\$12.50
SPELLING TUTOR 3 & 4	8K	\$12.50
FLASHCARD 1 & 2	8K	\$12.50
FLASHCARD 3 & 4	8K	\$12.50
SUPER SPY A	8K	\$12.50
SUPER SPY B	8K	\$12.50

SEGA SC 3000

TIME FOR A SEGA SC3000 SOFTWARE INSPECTION LATEST RELEASES FROM SOFTWARE CONCEPTS

GAMES PACK 1 STAR STRIKE

This tape contains two programs
Infiltrate the enemies massive planetary defence system. How far can you penetrate? FANTASTIC EXPLOSIONS. SOUND. Includes skill levels, incredible value for money.

\$24.95

ALIEN

Your mission to defend Earth. FAST ACTION GAME. Annihilate the Aliens before they infiltrate the last line of defence. Unless destroyed they appear stronger, faster and more powerful than ever. All you have to stop them with is your high output intercept laser system.

\$19.95

GAMES PACK 11

This tape contains two games. The popular CHECKERS and TIC-TAC-TOE. Hours of endless fun. Based upon the ever popular family entertainment games. Try and outsmart the computer.

\$19.95

CRUSADER

First of the TRILOGY. Join the world of action packed adventure with the CRUSADERS. You become KYRIK STURT their leader. The fanatical guardians of the fragile structure of intergalactic peace are up against their most dangerous mission. Galactic catastrophe is only zones away. EXCEPTIONAL GRAPHICS-SOUND-BRILLIANT concept includes combat manual.

\$29.95

PYRAMIDS OF MARS

This is a TEXT ADVENTURE. Skill, logic and patience are required. Danger lurks around every corner. Now you can have an adventure without ever leaving your chair. You seek the lost treasure of the underground caverns deep within Mars. Playing time in excess 5 hours.

\$19.95

All programs supplied with Luxury Collection Binder, and free catalogue tape* offer ends 31st June. All programs run on standard Sega Computer.

WATCH FOR: PURSUIT, ALERT, CRUSADER II, M.C. TUTORIAL, INTER-GALACTIC SPYCATCHER AND MANY MORE

SPECTRUM SOFTWARE

TITLE	MEMORY REQUIRED	R.R.P.
COSMIC RAIDERS	16/48K	\$24.00
CREEPY CRAWLER	16/48K	\$25.00
CRUISE ATTACK	48K	\$25.00
DEFENDER	48K	\$25.00
GALAKZIONS	16/48K	\$22.00
KNOCKOUT	48K	\$25.00
LASER WARP	48K	\$25.00
MASTER CHESS	48K	\$25.00
MAD MARTHA	48K	\$25.00
NAANAS	16/48K	\$25.00
180	48K	\$25.00
PARADROIDS	48K	\$25.00
PAT THE POSTMAN	48K	\$25.00
SORCERER'S CASTLE	48K	\$25.00
SCRAMBLE	16/48K	\$22.00
SAS ASSAULT	48K	\$25.00
LAND OF SAGAN	48K	\$25.00
TIME QUEST	48K	\$25.00
SPACE ZOMBIES	16/48K	\$25.00

PLUS 30 MORE TITLES, SEND SSAE FOR COMPLETE CATALOGUE

30 TITLES

SEND SSAE FOR CATALOGUE

40 TITLES

SEND SSAE FOR CATALOGUE

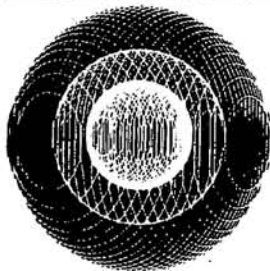

SOFTWARE CONCEPTS

P.O. BOX 315, MATRAVILLE, 2036.

SYDNEY, AUSTRALIA.

PHONE: (02) 661 6184

SOFTWARE SPECIALISTS SEGA SC3000 — VZ200 — COMM 64 — VIC 20 — BBC 'B' —SPECTRUM

ORDER FORM Complete in block letters

TITLE	QTY	PRICE	VALUE	NAME
				ADDRESS
				SIGNATURE
				COMPUTER TYPE
				SSAE Catalogue only

ADD \$1.50 cert. post and packaging \$1.50

I enclose crossed cheque/money order
to the value of

Bankcard NO.

Expiry date

Made payable to SOFTWARE CONCEPTS,
P.O. Box 315, Matraville N.S.W. 2036

DEALER ENQUIRIES WELCOME



more participants, could be accommodated by simple adjustments. As each score is entered, the running total is printed into the appropriate column.

'999' is employed as the terminator and when this is entered the total scores are printed out in rank-order. Then the printer scrolls back to the top score and proceeds to print the position and name against the scores. This use of the Sharp printer's negative line-feed capability saves a lot of programming space by utilising the left and right justification features of numerical and string printing.

After these gymnastics, the computer gives you the winning margin and each player's best individual score. Finally, the time at which the game ends is given and the LCD display offers you the chance to repeat the performance if the order and names of players is not changed.

If the timer option is used, you are reminded of the passage of time by regular bleeps; for the last part of the period the bleeps increase in frequency to add a little stress.

The printed record is often prized by the players, particularly the winners

and those who make the best individual scores. 'Scrabble' addicts, in particular, like to keep records of their feats. Perhaps it would be a good idea to add a repeat print-out option for those occasions when more than one player wants a copy. It may not become the Belle of the Ball, but in this role the pocket micro can find its way into polite society and make new friends. One even finds people volunteering to keep score, and strangely, they are often those who normally shun such tasks and treat electronic devices with the greatest suspicion.

LOAD 80

FOR TRS-80[®] MOD I & III
AND SYSTEM 80

NEW

+

INSTANT COCO

Concerned with great LOAD
80 programs like AIDSIII

FOR TRS-80[®] COLOR
COMPUTER

Replacing **COLOR LOAD 80**)
Available from January 1984

YOU HAVE READ
80 MICRO AND HOT COCO
FOR THE UNIQUE PROGRAMS

★ ★ **NOW** ★ ★
USE A CLOAD

AND SAVE HOURS OF TYPING
AND FRUSTRATION
ALLOW 14 DAYS DELIVERY

CASSETTE
LOAD 80
OR INSTANT COCO
ONLY

\$19.95 EA.
(Back issues avail-
able on request)

*TRS-80 & Color Computer are Trademarks of Radio Shack, Tandy Corp.

I WISH TO ORDER

Load 80 Nov 83 Dec 83 Jan 84 Feb 84

Instant Coco Jan 84 Feb 84

My Cheque/Money Order is enclosed \$

Name:

Address:

Phone:

Post & Packing \$1.00 Per Cassette

AUSTRALIA COMPUTER SOFTWARE
P.O. BOX 450, MALVERN, 3144 VICTORIA
PHONE: (03) 20 4947 DEALER ENQ WELCOME

INTRODUCING
the best value in personal computers.



EPSON QX-10

256 K RAM : 2x320 K DRIVES
640x400 DOT GRAPHICS
REAL TIME CLOCK AND CALENDAR
2x RAM DRIVES : BATTERY BACKUP
16 CHARACTER FONTS

RS 232C PORT : LIGHT PEN INTERFACE
CENTRONICS PARALLEL PORT
COLOUR OPTION AVAILABLE
5 SLOT EXPANSION BUS
FAST VOICE COIL MOTOR DISK DRIVES

18 PROGRAMMABLE FUNCTION KEYS

12" ANTIGLARE GREEN SCREEN, FX-80 PRINTER, WORDSTAR,
MAILMERGE, SPELLSTAR, BASIC AND EXTENDED CP/M 2.2

ALL INCLUDED IN ONE LOW PRICE **ONLY \$4,954** incl. Tax

MasterCard.

C.A.E. ELECTRONICS Pty. Ltd.
1/27 FORGE STREET, BLACKTOWN
(02) 6214242



How to buy a business micro

— a specially commissioned 16 page guide to
selecting what is probably your most important
purchase this decade. Beware of the pitfalls!

AUSTRALIAN BUSINESS
COMPUTER

On sale now at leading newsagencies. \$2.95

DON'T WASTE YOUR VALUABLE SOFTWARE, MONEY OR TIME!
 BEST PRICES ON APPLE COMPATIBLE GEAR FROM

SOUTHERN CROSS RESOURCES

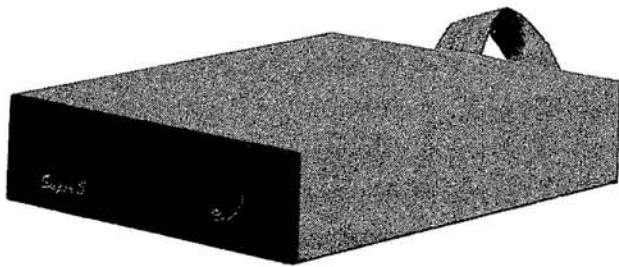

The Super 5 Quality Disk Drives

- Quiet, reliable operation
- Direct from Japan ● TEAC Mech.
- 6 months warranty ● 14 day money back trial

NEW SHIPMENT — NEW PRICE!
 NORMALLY \$448.00 NOW **\$330.00** incl tax!

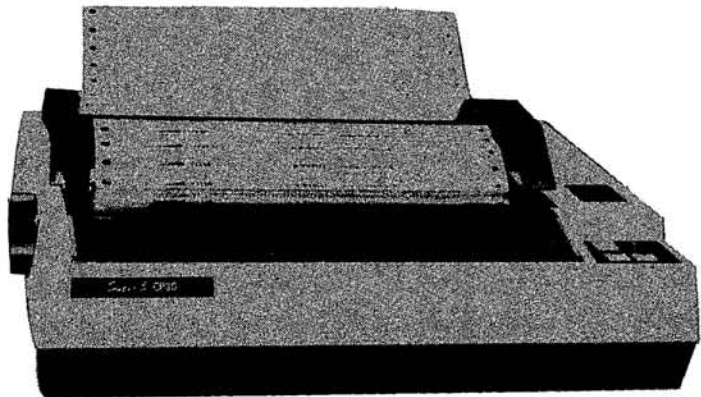

The Super 5 CP80 Dot Matrix Printer

- Flexible, friction and tractor drive
- 25 User selectable type styles
- 640 graphic dots/line density
- Epson FT type III compatible

NEW SHIPMENT — NEW PRICE!
 NORMALLY \$618.00 NOW **\$469.00** incl. tax



The Keypaddle

Tectron's new multifunctional keypad for use with the Apple II « computer

For serious business

- 16 key calculator-like keypad makes data entry easy
- For hand held or desk top use
- Create and control graphic displays

For serious fun

- Keypaddle works with all existing paddle games
- Firing buttons on both sides mean easy use by righties and lefties
- Two-sized dial for maximum ease in turning

Fantastic features

- Easy-push keyboard buttons
- Tactile and aural feedback from pressed side buttons
- Flexible, curled cord won't get in the way
- Compact size (5 5/16" x 3" x 5/8")
- Easy installation

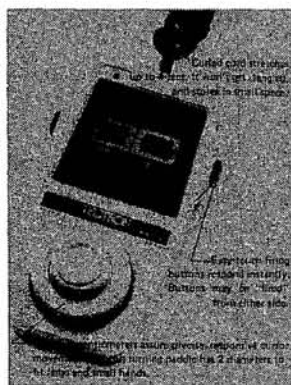

This multifunctional Keypaddle serves as a Visi-Calc data entry device with cursor control, and game/graphics paddle controller. A push on the "firing button" is all that's necessary to switch in and out of Visi-calc mode.

- Single unit for hand held operation of games and Visicalc **\$65.00**
- Double unit as above **\$85.00**

NOTE: Full Visicalc operation not possible with Apple IIe

Also available APPLE COMPATIBLE:

- | | |
|----------------------------------------------------------|--------------|
| ● DISK CONTROLLER CARDS | incl. tax! |
| ● PARALLELINTERFACE PRINTER CARDS (with cable) | \$55 |
| ● 16K RAM EXPANSION CARDS | \$75 |
| ● Z80 CARDS for CPM operation | \$65 |
| ● SPEECH SYNTHESISER CARD (with speaker and disk) | \$60 |
| ● PAL TV INTERFACE CARDS | \$80 |
| ● PAL CARD with modulator for SOUND thru TV | \$85 |
| ● 80 COLUMN CARD | \$120 |
| ● 80 COLUMN CARD with auto recognition SOFT SWITCH | \$90 |
| ● 16K PRINTER BUFFER CARD | \$105 |
| | \$260 |

PAY MONEY ORDER CHEQUE BANKCARD
 Send to: **SOUTHERN CROSS RESOURCES**

461 PACIFIC HIGHWAY, ARTAMON, NSW, 2064

Bankcard No.

Expiry Date

Name

Address

..... Signature

PHONE: (02) 427 3099 ADD \$5.00 POSTAGE

CALL-IN OR WRITE FOR FOR 1st and \$2.00

MORE INFORMATION FOR EACH OTHER ITEM

PRICES HOLD ONLY WHILE STOCKS LAST!

GAMETRONICS SOFTWARE EXPLOSION

for Sinclair ZX SPECTRUM

HARDWARE

PROGRAM NAME	PRICE
Spectrum Computer 16K	\$265.00
Spectrum Computer 48K	355.00
ZX Printer	169.00
Printer Paper	4.50
MX 82 Epson Printer	540.00
Cent/Interf inc Cable & W. Processor	120.00
Digital Tracer & Software	190.00
Lightpen & S/Ware	69.95
Loading Aid Sure Load Every Time	25.00
Speech Synthesiser Phonetic	120.00
Sound Generator 3 Channel	99.00
Digital I/O Port Module	120.00
Analog Input Port Module	120.00
Analog Out Port Module	120.00
Realtime Clock Module	59.00
Light Pen Module	140.00
Joystick Interface	45.00
TV Sound Module	29.00
Full Size Keyboard	120.00

COMPUTING

Convert ZX81 to Spectrum 16K	19.95
Display Generator 16K	14.90
Infrared Disassembler 16K	29.00
M-Coder II Compiler 48K	29.95
Machine Language i6K	20.00
Melbourne Draw 48K	29.95
Speakeasy 48K	15.95
Spectrum Forth 48K	39.95
Spectrum Assembler 48K	39.95
Spectrum Print Util's 48K	18.95
Spectrum Bug 2 16K	25.00
Super Draw 16K	22.00
Sys 64 16K	25.00
Ultraviolet Assembler 48K	33.00
Use & Learn 16K	35.00
Viepoint 3D 16K	29.00
VU-3D 48K	25.00
Hurg 48K	39.95
Sound FX 48K	22.00
Distron 16K	22.00
Zxed Toolkit 48K	29.00
SPDE 16K	25.00
Abersoft Forth	44.00
Games Designer	44.95
Pascal Compiler	00.00

GAMES

3D Combat Zone 48K	\$22.00
Arcadia 48K	25.00
Avenger 48K	22.00
Cosmic Raiders 16K	24.00
Cosmic Debris 48K	22.00
Crazy Balloons 16K	25.00
Devil Birds & Digger Man 16K	26.00
Dodge the Demon Driver 16K	26.00
Embassy Assault 16K	19.95
Flight Simulator 48K	25.00
Frog 5 Snow Down 16K	22.00
Frogger 16K	25.00
Galactic Patrol 16K	25.00
Galaxians 16K	22.00
Games 1 16K	20.00
Games 2 16K	20.00
Games 3 16K	20.00
Games 4 16K	20.00
Games 5 Star-Trail 48K	20.00
Games 6 16K	20.00
Gobbleman 16K	22.00
Horace and the Spiders 16K	20.00
Horace goes Skiing 16K	20.00
Hungry Horace 16K	20.00
Invaders 16K	22.00

Invasion Force 16K	22.00
Light Cycle 16K	22.00
Maze and Death Race 48K	22.00
Meteor Storm 16K	22.00
Nightmare & Dragon Maze 16K	23.00
Over the Spectrum 1 16K	20.00
Over the Spectrum 2 16K	20.00
Over the Spectrum 3 16K	20.00
Penetrator 48K	22.50
Planetoids 16K	20.00
Schizoids 48K	25.00
Sentinel 48K	22.00
Space Zombies 16K	24.00
Space Intruders 16K	22.00
Space Raiders 16K	22.00
Space Rescue & Star Quest 16K	23.00
Star Trek 48K	22.00
Terror-Dakili 4D 48K	22.50
Timegate 48K	29.00
Trog 48K	28.50
Monte Carlo 16K	22.00
Panic 48K	20.00
Armageddon 16K	20.00
Digger Dan 16K	20.00
Kong 48K	20.00
Electra Storm 48K	20.00
Break Away 16K	20.00
Luna Crabs 16K	22.50
Mind Out 48K	22.50
Frenzy 16K	22.50
Astro Blaster 16K	22.50
Trader 48K	29.50
Jetpac 16K	25.00
Cookie 16K	25.00
Pssst 16K	25.00
Tranz Am 16K	25.00
Ant Attack 48K	25.00
Bugaboo the Flea 48K	25.00
Traxx 48K	25.00
Velnors Lair 48K	25.00
Xadom 48K	25.00
3-D Strategy 48K	25.00
Smugglers Cove 48K	25.00
Aqua Plane 48K	25.00
Paradroids 16K	25.00
Pat the Postman 48K	25.00
Naanas 16K	25.00
180 16K	25.00
SAS Assault 48K	25.00
Cruise Attack 16K	25.00
Time Quest 48K	25.00
Laser Warp 48K	25.00
Defender 16K	25.00
Knockout 16K	25.00
3D Tanx 48K	22.00
Centi-Bug 16K	22.00
Meteoroids 16K	22.00

Dictator 48K	22.00
Spawn of Evil 48K	22.00
Jawz 16K	22.00
Maziacs 48K	29.00
Gold Mine 16K	22.00
Hard Cheese 16K	22.00
Star Trek 3000 48K	22.00
Speed Duel 48K	25.00
Apple Jam 16K	25.00
Trom 48K	25.00
2003 Space Oddity 16K	22.00
Slicker Puzzle 48K	29.00
Jumbly 48K	29.00
Blind Mice 16K	25.00
Gulpman 16K	19.95
Hopper 48K	25.00
Road Toad 16K	22.00
Haunted Hedges 16K	22.50
I Am In Stock 16K	19.50
Dimensions Destructors 48K	19.50
Earth Defence 16K	19.50
Millimon 16K	19.50
Snake 16K	19.50
Monkey Bizness 48K	19.50
Road Racers 16K	19.50
Galaxians 16K	19.50
Jet Pac 16K	25.00
Trans AM 16K	25.00
Cookie 16K	25.00
Pssst 16K	25.00
Lunar Jetman 48K	25.00
Alic Atac 40K	25.00

Chess Tutor 16K	25.00
ABC Lift Off 16K	25.00
Count About 16K	25.00
Hot Dot Spotter 16K	25.00
Fruit Machine 48K	22.00
Golf 16K	22.00
Diet 48K	29.00

ADVENTURES

Land of Sagam 48K	25.00
Adventure in Time 48K	\$14.90
E.T. 48K	23.50
Espionage Island 48K	22.50
Forbidden City 16K	16.95
Gold 16K	26.00
Golden Apple 48K	25.00
Haunted Palace 16K	16.95
Inca Curse 48K	22.50
Mad Martha 48K	29.95
Mines of Saturn 16K	24.00
Planet of Death 16K	22.50
Rescue 48K	25.00
Ship of Doom 48K	22.50
The Hobbil 48K	39.95
The Orb 48K	25.00
Towers of Doom 16K	16.95
Pilman Seven 48K	22.50
Johnny Reb 48K	22.00
Privateer 48K	22.00
Roman Empire 16K	22.00
Samurai Warrior 16K	22.00
Paras 48K	22.00
Redweed 48K	22.00
Warlord 48K	22.00
Tyant of Athens 16K	22.00

BOOKS

Understand Your Spectrum	\$17.95
Spectrum Machine Lang for Beginner	17.95
Over the Spectrum	15.95
The Complete Spectrum ROM Disassembly	23.95
Spectrum Hardware Manual	17.95
Spectrum Microdrive Book	24.95
Supercharge Your Spectrum	19.95
Exploring Spectrum Basic	16.95
Sinclair User Magazine	5.50
ZX Computing Magazine	6.50
Sinclair Projects	5.50
Sinclair Programs	5.50
Users Book of Tape Recording	19.95

CHALLENGE

Psion Chess 48K	\$25.00
Chess Tutor 16K	25.00
Spectrum Chess 48K	27.00
Spectrum Voice Chess 48K	27.00
Cyrus is Chess 16K	27.70
Cyrus is Chess 48K	27.70
Monte Carlo 16K	22.00
Roulette 16K	22.00
Jackpot 48K	25.00
Backgammon 16K	25.00
Dominoes 16K	22.50
Reversi 16K	22.00
Brainstorm 16K	22.00
Pool 16K	20.00
Pontoon 48K	25.00
Handicap Golf 48K	25.00
Test Match Cricket 48K	25.00
Football Manager 48K	29.00
Auto Chef 48K	25.00
Dallas 48K	25.00
30 Quadracube 16K	22.00
Break Away 16K	22.00

BUSINESS

Small Bus. Accounts 48K	39.00
Mailist 48K	55.00
Data Base 48K	55.00
Spectrum Voice Chess 48K	27.00
Comp-U-Share 48K	\$35.00
Comp-U-Tax 48K	35.00
Home Banking 48K	35.00
Spreadsheet 48K	35.00
Vu-File 48K	25.00
Vu-Calc 48K	25.00
Stock Control 48K	55.50
Critical Path Analysis 48K	55.50
Collectors Pack 16K	22.50
Club record Controller 48K	22.50
Mat Calc 16K	14.90
Protex W. Processor 48K	24.90
Eddie A Word Processor 48K	25.00
Personal Finance 48K	29.00
Masterfile 48K	39.95
Masterfile 16K	25.00

FREE OFFER!

Two free computer data cassettes with every order over \$30.00

gametronics

Shop 6/177 Toorak Rd, Sth Yarra 3142
Telephone: (03) 241 3031

MAIL ORDER

CHEQUE/MONEY ORDER/BANK CARD/NO.
PLEASE SEND ME
SPECTRUM 16K
SPECTRUM 48K

PRICE	QTY.
\$289.00
\$389.00

TOTAL AMOUNT PAYABLE
ADD \$8.50 P&P H/WARE ex
NAME..... ADDRESS.....
CITY.....
P/CODE..... EXP. DATE.....
PLEASE SEND FREE CAT.
SIGNATURE.....

EVERYTHING YOU EVER WANTED TO KNOW IN ONE MAGNIFICENT VOLUME

If you subscribe to *Australian Personal Computer* this month you will receive not only 12 issues of the biggest and best micro magazine in Australia just as soon as it comes off the presses, but you will also get a FREE copy of Peter Rodwell's book, *The Personal Computer Handbook*, worth \$19.95.

The Personal Computer Handbook was written by Peter Rodwell, a name well known to APC readers as one of the most authoritative Benchtesters and reviewers in the micro industry. It contains over 200 pages of information on personal computers — from an introduction to computers, what they are and how they work, to a look at what's in store for personal computers in the future and reviews of machines from Apple, IBM, Atari and Commodore to name just a few. It's a large, almost coffee-table sized book of 208 pages, 30 of which are in full colour!

To get a year's subscription to APC and your FREE copy of *The Personal Computer Handbook*, all you have to do is fill in the subscription order form opposite and send it off to us. Lucky existing subscribers who want to take advantage of this offer can do so by just extending their subscriptions for another year.

DON'T WAIT. GET YOUR COPY NOW — BEFORE THEY RUN OUT.

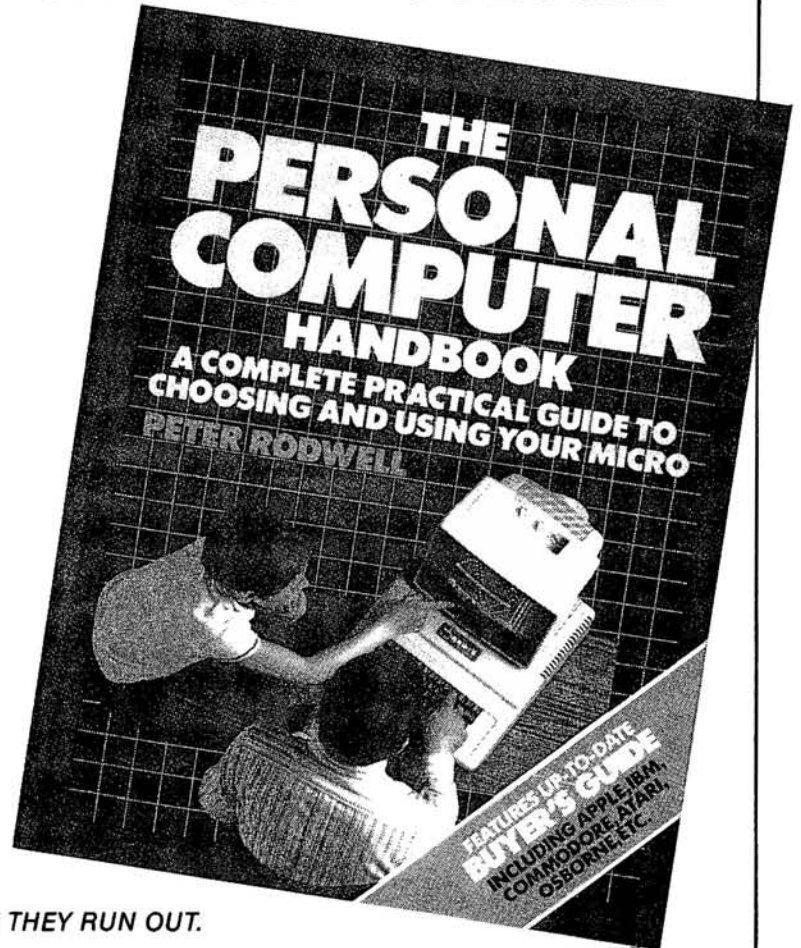

MICROMAIL

From May 1

New Showroom Opening Specials
**NO. 1 303 PACIFIC HIGHWAY, LINFIELD
 NSW 2070**

New Phone Numbers: (02) 467 1933 (02) 449 5600

Order Line Outside Sydney: (008) 23 0200

FOR THE COMMODORE 64

'COLOSSUS CHESS 2-0'



Colossus Chess 2.0
 The World Champion
 Chess Game
 has beaten Grandmaster
 12 to 4 and White Knight,
 the 1983 Home Computer
 European Champion, 11
 to 5.

	RRP	Micromail
Cass.	\$35.95	\$29.95
Disk	\$39.95	\$34.95

For Adults Only WANDA
 — from the Games
 Machine (UK). Also
 Egbert, Aagh Condor,
 SKULL.

	RRP	Micromail
Cass.	\$29.95	\$24.95



From **Mr Chip RED ALERT** — a
 spy game for 1-4 players. Also,
 Jackpot 64, Westminster,
 Wh\$er Dealer, Lunar Rescue.

	RRP	Micromail
Cass.	\$24.95	\$19.95

Also **CHIPMON**, contains 1 + 2
 pass assembler, disassembler +
 monitor for development of
 machine code programs and
 routines.

	RRP	Micromail
Cass.	\$44.95	\$39.95



THE BOSS (Peaksoft). Your job is to
 build the best team possible to win the
 league, cup, and European Cup. Has
 9 skill levels + more. Complete with
 save game tape.

	RRP	Micromail
Cass.	\$33.95	\$27.95



Soon to be released.

Titles from Quicksilva, DK Tronics, Virgin and Anger
 Productions.

All the above titles are distributed by **MAILSOFT**

Introducing

BC BASIC

A Micromail Exclusive
 Adds 104 Commands and Functions to the
 Commodore 64. **ONLY \$80 (cart.)**

CATEGORY OF FUNCTIONS	BC BASIC			SIMONS' BASIC		
	Ease	Use	Reliability	Ease	Use	Reliability
Graphics set up	****	****	****	***	***	****
Plotting commands	***	***	****	****	****	****
Misc screen commands	****	***	****	****	***	****
Sprite set-up	****	****	****	****	****	****
Sprite programming	****	****	****	****	**	****
Keyboard input	***	**	****	**	****	**
Misc input/output functions	****	****	****	**	*	****
Sound set up	****	****	****	****	****	****
Sound programming	***	****	****	**	***	***
String commands	****	****	****	**	****	*
Arithmetic commands	****	****	****	**	***	**
Structured programming	****	****	****	****	****	****
Programmer aids	none	none	none	****	**	***
Total points	49	47	59	43	42	47

"BC Basic is very robust and bug free. It's commands
 are well thought out and much more versatile and
 useful in practice than Simon's Basic" — Commodore
 User Mag. (UK).

MEMOTECH



Micromail Exclusive

Memotech MTX 500 32 k User Ram
 Memotech MTX 512 64 k User Ram
 Expandable to 512 k Ram
 Z80A processor 4 MHz. Built in software — MTX Basic, MTX
 Logo, Noddy, Assembler, Disassembler. Optional CPM
 Floppy Disk System 5¼" Qume Drives — 500 k capacity each
 Silicon Disc (¼ MB) increases the efficiency of 8 bit software
 to those of 16/32 bit software. Hard Disk — 5¼" Winchester 5,
 10, 20 MB.
 MTX 500 Computer **Only \$699**
 MTX 512 Computer **Only \$799**
 New Word w/p cart. **Only \$219**
 FDX Floppy Disk System **call**
 Software from **\$19.95** **call**

Australia's No. 1 Microcomputer Mail Order Club.

SPECIAL INTRODUCTORY OFFER: FREE MEMBERSHIP WORTH \$30 WITH PURCHASE OF \$100 OR MORE ON INITIAL ORDER.

SPECIAL OFFER OF THE MONTH PART I

**Commodore 1541 RRP Micromail
Disk Drive \$499 \$395**

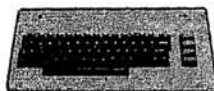

SPECIAL OFFER OF THE MONTH PART II

**BC Basic (cart.) Exclusively from
Micromail \$80**



Commodore

	RRP	Micromail
Prices include sales tax		
Commodore 64	\$499.00	\$399.00
Datasette	49.95	43.95
1526 Printer	499.00	439.00
1701 Colour monitor	499.00	449.00
S-64 Portable	1499.00	1399.00
Koala Pad	149.95	134.95
Light Pen	39.95	35.95
Parallel Interface	119.00	106.95
Advanced Calc Result	200.00	179.00
Superbase 64	180.00	149.00
Simons Basic	80.00	74.95
Multiplan	149.00	129.00
Intro to Basic 1/2	40.00	32.95
Easy Script	100.00	85.95
The Manager	100.00	85.95
Home Accountant	105.00	89.95
Jumpman	54.95	46.95
Commodore joystick	12.00	10.50
Zork I, II, III	25.95	21.95
Homeword	59.95	52.95
Typing Tutor	19.95	17.95
Bank Street Writer	83.95	75.95
Flight Simulator	64.95	57.95
Choplifter	54.95	46.95
Data Manager	29.95	25.95
Programmer's Reference Guide	28.00	20.00
Colossus Chess	35.95	29.95
Donkey Kong	69.95	62.95
Grandmaster	29.95	25.95
Loderunner	54.95	46.95
Computer Tutor	79.95	69.95
Wordpro Plus 64	180.00	130.00

and more!

ATARI

	RRP	Micromail
Prices include sales tax		
600XL	\$399.00	\$359.00
800XL	599.00	549.00
1050 Disk Drive	699.00	629.00
1010 Program Recorder	159.00	149.00
Koala Pad	149.00	139.00
Choplifter	48.95	42.95
Atari Writer	119.95	105.95
Donkey Kong	79.95	69.95
Paint	99.95	89.95
Zaxxon	58.95	49.95
More software	Call	Call

and more!

SPINTRAVEL

	RRP	Micromail
Prices include sales tax		
SV-318	\$399.00	\$299.00
SV-328 80K RAM	699.00	599.00
Data Cassette Drive	149.00	99.95
SV-328 Floppy Disk System	1599.00	1399.00
MSX manual	—	\$20.00
Software	Call	Call

and more!

apple.

	RRP	Micromail
Hardware excluding sales tax		
CED Par/Ser	\$135.00	\$115.00
Apple Fan	120.00	105.00
Micro Fazer	390.00	349.00
Digitek Printmaster	202.00	174.00
Davong 5 Meg. Drive	2880.00	2399.00
Other hardware	Call	Call
Software includes sales tax		
Bank Street writer	598.95	586.95
Homeword	59.95	52.95
Zardax	324.00	258.00
Visicalc	428.00	225.00
PFS File, Graph, Report	175.00	139.00
D Base II	825.00	689.00
Home Accountant	105.00	86.95
Versaform	570.00	459.00
Master Type	64.96	54.95
Frogger	48.95	39.95
Wizardry	81.95	69.95
Choplifter	48.95	39.95
Loderunner	48.95	41.95
Defender	72.95	64.95
Pacman	72.95	64.95
Flight Simulator II	56.95	46.95
Sargon II	56.95	48.95
Zork I, II, III	60.95	50.95
Other software	Call	Call

Sindair

ZX Spectrum 16K	299.00	269.00
48K	399.00	349.00
Microdrive	149.00	135.00
ZX-I Interface	149.00	135.00
CPM Software	Call	Call
Microsoft Software	Call	Call
Typequick	80.00	60.00

Manufacturer's full warranty on all products.

SANYO (16 bit)

	RRP	Micromail
Prices include sales tax		
MBC 550 PC + 160K Drive	\$1495.00	\$1395.00
MBC 550/2 PC + 320K Drive	1995.00	1850.00
MBC 555 PC + Dual 160K Drives	1995.00	1850.00
MBC 555 PC + Dual 320K Drives	2595.00	2450.00
Micropro Wordstar/Calstar	195.00	180.00
Micropro Mailmerge + Spellstar + Infostar	295.00	275.00
More hardware and software	Call	Call

IBM

	RRP	Micromail
Software includes sales tax		
LOTUS 1 2 3	\$950.00	\$659.00
Sybiz software	Call	Call
Padmede Accounting Modules	390.00	325.00

Wordstar Professional	795.00	639.00
Wordstar 3.24	595.00	199.00
Spellbinder	695.00	495.00
The Word Plus	249.00	199.00
Supercalc 3	445.00	369.00
D Base II	825.00	689.00
Friday	360.00	320.00
Multimate	595.00	495.00
Championship Blackjack	69.00	58.95
Sargon II	54.95	48.95
Flight Simulator	87.95	74.95
Zork I, II, III	59.95	49.95
Multiplan	395.00	295.00
Hardware excludes sales tax		
Quadboards	Call	Call
Davong 64K Ramcard exp.	359.00	299.00
Quadlink	875.00	699.00
Davong 5MB Drive (EXT)	2880.00	2399.00
Persyst Boards	Call	Call
AST Boards	Call	Call
TEAC Disk Drive 320K	750.00	450.00
Other hardware	Call	Call

FLOPPY DISKS

Le Floppie (10) SSDD	49.95	37.95
2 Pack Le Floppie	10.00	8.95
Le Floppie (10) DSDD	80.00	59.95

MONITORS inc. sales tax

	RRP	Micromail
Kaga Green	\$269.00	\$249.00
Teco Green Screen	249.00	199.00
Teco Amber Monitor	275.00	220.00
Sanyo Anti Glare Green	299.00	279.00
Kaga Green/IBM PC Monitor	327.00	309.00
Kaga Amber/IBM PC Monitor	340.00	319.00
RGB + Composite Video Colour	463.00	435.00
RGB Colour 640 x 262	775.00	725.00

PRINTERS including sales tax

Amust DT 80	449.00	399.00
Star Gemini 10x	599.00	475.00
Pony	199.00	Call
Star Gemini 15x	955.00	795.00
Euchida Daisy Wheel 20cps	799.00	649.00
SP 2000 Daisy Wheel	995.00	745.00
Juki 6100 Daisy Wheel	995.00	895.00
C-Itoh 8510 parallel	1340.00	995.00
C-Itoh 1550 parallel	1635.00	1295.00
NEC printers	Call	Call

MODEMS including sales tax

	RRP	Micromail
Cicada 300	\$250.00	\$210.00
Cicada 300T	275.00	240.00
Cicada for Commodore 64	275.00	225.00
Cicada 300T for Commodore 64	295.00	249.00

JOYSTICKS

Quickshot I	24.95	19.95
Quickshot II	29.95	25.95
Triga Command	24.95	19.95
Kraft	88.95	79.95
Wico 3 way joystick	49.95	45.95
Wico Apple II joystick adaptor	34.95	31.95

FOR ALL PRODUCTS NOT LISTED CALL (02) 449 5600 or (02) 467 1933

Order by phone Sydney 449 5600, 467 1933 Australia Wide (008) 23 0200 (Toll Free) 24 Hour Service Bankcard and Mastercard Welcome

Visit our showroom from May 1 at No. 1-303 Pacific Hwy, Linfield NSW 2070. Open Saturdays

Despatch guaranteed in five working days. Shipping and handling charges: -Sydney - \$5.00, anywhere in Australia - \$10.00
Courier delivery. Prices subject to change without notice.

Or send cheque or money order to
**Micromail No. 1-303 Pacific Hwy,
Linfield NSW 2070**

Members receive: Discount vouchers for future purchases. Free cassette or diskette. Microgram bimonthly publication.

MORROW MICRO DECISION

COMPUTER SPECIFICATIONS.

- Z80A CPU operating at 4MHZ.
- 64K RAM + 4K ROM (MD2 MD3) 128K MD11 + 8K ROM
- 5¼" Floppy Disc Drives (400K MD2 800K MD3)
- 5¼" Hard Drive 11.0 Meg Formatted (MD11)
2 x RS232 Serial & 1 x Centronics (MD2, MD3) + High Speed Port MD11
- RFI Inhibiting fabricated metal case with moulded plastic front panel.

SOFTWARE SPECIFICATIONS.

- CP/M 2.2 Operating System.
- Wordstar word processing MD2, MD3.
- New Word MD11
- Correct-it spelling checker
- Logicalc Electronic Spreadsheet
- Personal Pearl Data Base
- Quest Bookkeeper (Not available with MD2)

**MORROW
DESIGNS
THE MICRO
DECISIONS
TO PROVIDE THE
BEST VALUE FOR
YOUR DOLLAR IN
THE PERSONAL
COMPUTER
MARKET**



**TURN TO
MORROW TODAY**

The Professionals Choice

FULLY SERVICED THROUGHOUT AUSTRALIA BY YOUR MORROW DISTRIBUTOR

IMPORTED & SUPPORTED BY
AUTOMATION-STATHAM PTY. LTD.
47 BIRCH ST.
BANKSTOWN NSW 2200
(02) 709 4144

A FULL SERVICE MORROW
DEALER SINCE 1976
TRADE ENQUIRIES WELCOME
S.A. (08) 332 0122

ASSCO PTY. LTD.
153 ELEY RD.,
BLACKBURN 3130
VICTORIA
(03) 233 6355

The risk game

Should computer software companies strive to be innovators in the field of business applications at the risk of sound financial gain? Peter Bright cogitates.

Microcomputer software is in a rut. This is true not only of business software but of home computing software as well. I can only put it down to a terminal tunnel vision which seems to be affecting most of today's software vendors.

Let's take a look at the history of micros in general and micro software in particular. Business micro software breaks down into four neat areas: spreadsheets, databases, word-processors and accounting systems. The most recent addition to the list was spreadsheets with the advent of VisiCalc. Since then, we have been faced with more and more VisiCalc lookalikes proclaiming they are better because they can print graphs, dance, sing, and so on. The same thing has happened throughout the software industry — a great many people expend a great deal of effort creating a product which is functionally very similar to all the other variations on that theme on the market.

Why has this happened? I can only put it down to a lack of faith on the part of the people who now run the major software producing companies. Let's look at the companies which produced some of the most functionally original products in the business sector: MicroPro, which makes WordStar; Visicorp, which gave us VisiCalc; and Ashton Tate, which markets dBase II.

Early days

When these companies were first established they were designing new products which enabled users to do things with their micros not previously possible. The companies were taking a risk — would anyone buy their products? For example, when VisiCalc was first released, who could say that anyone would want to use computerised spreadsheets? Nothing similar existed even on mainframes — how can the market be measured for something that doesn't exist?

At that time, I was employed in the accounts department of a large firm. Part of my job was to control certain accounts by writing the balances onto an A3 sheet of paper in pencil, and then at the end of the month rubbing all the

entries out and starting again. If we'd had VisiCalc in the office the time saving would have been enormous.

However, let's look at what these once-pioneering companies have done since their early days. MicroPro has moved into the database area, Ashton Tate has stayed with databases and Visicorp has opted for user friendly interfaces with its Visi On package.

Of these, the first two have taken the 'safe' route — they have remained faithful to their original products and have not expanded the uses of the micro any further. This sounds very much like the British motor cycle industry to me — do you remember Triumph? The company stayed with what it had, and look what happened.

Another trait that has typified the micro software industry for the past two or three years is its liking for 'flavour of the month' software — at the moment, it's multiple windows, icons and mice. Last year it was colour graphics: it's anyone's guess what it will be next year. Visicorp has followed the trend with Visi On, which uses multiple windows to integrate different packages onto one screen. On the face of it Visicorp seems to have done better than MicroPro and Ashton Tate. Visi On does represent an advance in the way that packages are presented to an end user. The trouble is, I am not sure the whole user-friendly idea fits my criteria for expanding micro horizons. To my mind, mice, windows *et al* do not expand what you can do with a micro. They may make applications packages easier to use, but don't allow you to do anything you couldn't do before. So maybe Visicorp hasn't been as brave as it looks.

Expansion and innovation

Why have these companies not continued to expand micro horizons? The answer applies to a great many com-

**SOME OF AUSTRALIA'S BIGGEST COMPANIES
WOULDN'T BUY
ONE OF THESE...
...WITHOUT
ONE
OF THESE**





PH 614 1433 561 BOURKE ST MELBOURNE 3000

In microcomputers, as in any machine, a system is only as good as its backup. Which is our strong suit, at Microcomp, with custom-designed programs, full service and replacement machines, and a fully-equipped Computer Training Centre.

This, combined with a successful four-year track record in microcomputers, and a reputation for innovation, is why IBM and Sirius chose us to sell their products, and why you should request a copy of our Corporate Account Support Policy.

It makes very encouraging reading.



SAFE, SOUND, AND STATE-OF-THE-ART

B. S. MICROCOMP PTY. LTD., 561 BOURKE STREET, MELBOURNE 3000. CALL US ON 614 1433. JLM/MC21

NOW there is a REASON to buy a computer. Introducing ...

Meta-4

the australian data base adventure

A WINNER

WINNER of 1st PRIZE in the Business Division of the 1983 AUSOM Challenge programming competition sponsored by VERBATIM (Australia) Pty. Ltd.

META4 is a revolutionary new data base system which gives YOU full control of your computer with NO PROGRAMMING. No other Data Base system even comes near it. Now you can have an integrated Data Base system for your business for only **\$200.00**. META4 may be the ONLY program you need to buy for your computer

Continuing Our Special Introductory Offer. Complete META 4 System

\$200⁰⁰

Until 30th May 1984 (Manual Alone \$20)

BASIC FACILITIES

META 4 is a comprehensive Data base Management system, including

- FULL DATA BASE
- SIMPLE SPREAD-SHEET
- SIMPLE WORD-PROCESSING
- MAILING LISTS
- STANDARD LETTERS
- LABELS

THINK OF AN APPLICATION

META4 is suitable for a very wide variety of business, professional, academic and personal applications, such as

BUSINESS
 CUSTOMERS QUOTES
 ORDERS SALES
 INVOICES ACCOUNTS
 CREDITORS NAMES
 LETTERS ADDRESSES
 FINANCIAL LABELS
 SUPPLIERS PRODUCTS
 CATALOGUES PERSONNEL
 ORG STRUCTURE DEPTS

PROFESSIONAL
 MEDICAL DENTAL
 LEGAL PHARMACEUTICAL
 INSURANCE FARMING

ACADEMIC
 LIBRARY STUDENTS
 TIMETABLES SCORES
 BOOKS BORROWERS
 PAPERS AUTHORS
 REFERENCES LECTURES
 FORMULAE

INDUSTRY
 VEHICLES REPAIRS
 MAINTENANCE PRODUCTION

REAL ESTATE
 PROPERTIES ENQUIRIES
 ADVERTISING ADVENTS
 RENT COMMISSIONS

PROJECT
 TASK LISTS SCHEDULES
 DIARY MEETINGS
 MANUALS DOCUMENT N
 TIMESHEETS ESTIMATING
 BUDGETS

Information from any or all of the above applications can be AUTOMATICALLY LINKED & CROSS-REFERENCED since META4 is a true Data Base system.

BASIC CONCEPTS

META4 uses familiar concepts to aid you in it's use

ROOMS — META4 has many rooms in it. Each room is used to store information about a different type of thing.

QUESTIONS & ANSWERS — when you go into a ROOM META4 asks you QUESTIONS about the type of thing (e.g. CUSTOMER INVOICE, PRODUCT etc) held in the ROOM and stores away your ANSWERS.

RECORDS — META4 stores the ANSWERS to a set of QUESTIONS in a room as a RECORD. There can be many RECORDS in a room.

DOORWAYS — You can move from ROOM to ROOM through DOORWAYS. META4 automatically relates information in one ROOM to information in the next.

BUILDINGS — A building is a collection of related ROOMS and DOORWAYS. A BUILDING corresponds to the traditional concept of a Data base.

META4 IS PORTABLE
 Any applications you develop under META4 will run without change on any computer that META4 runs on.

EASE OF USE

- SIMPLE and CONSISTENT
- HELP — 3 levels for the current
 - BUILDING you are in
 - ROOM you are in
 - QUESTION being asked
- 3 TUTORIALS
 - USING META 4
 - DESIGNING WITH META 4
 - META 4 EXAMPLES

Designed from the ground up to be totally consistent and as easy to install, learn and use as possible.

META4 IS EXTENDABLE

All the features of the system are fully extendable to your own applications. You can add your own BUILDINGS, ROOMS, DOORWAYS, and QUESTIONS. You can define your own maps, HELP text and tutorials.

WRITTEN IN ITSELF

Only META4 is powerful and elegant enough to use itself! All the system documentation is stored in standard META4 BUILDINGS and printed out as a standard META4 report. When you use META4 to define a new application, you answer standard META4 questions in standard rooms in a META4 building.

DETAILED FACILITIES

- Menu driven
- True DATA BASE — RELATIONAL NETWORK
- Variety of Answer-types e.g. CALCULATED, DATE, YES/NO, NUMERIC, TEXT, LIST
- FULL PROMPTING
- Automatic VALIDATION
- Powerful Selection & Reporting
- All facilities fully EXTENDABLE to user's own applications
- No programming
- Full DATA DICTIONARY defined as a META4 application
- Automatic TOTALLING of lists.
- Automatic COPYING of ANSWERS from one room to another
- Automatic MAINTENANCE of records in other rooms (Secondary Index facility)
- Copying of information to and from other products such as WORDSTAR

DISK FORMATS AVAILABLE

- 5. IBM PC/DOS 320K
- 5. APPLE-II CP/M 126K
- 5. CP/M SS/SD 256K

Other formats by request

MINIMUM HARDWARE REQD.

CP/M — Minimum 56K System
 IBM PC/DOS, MS-DOS — Minimum of 128K RAM
 APPLE-II — 64K RAM, 80-Column Card, CP/M card, 2 diskette drives

Prices (inc. Sales Tax)

Manual alone \$30.00
 META 4 (CP/M) \$395.00
 META 4 (IBM-PC) \$595.00
 META 4 (MS-DOS) \$595.00
 Non-Standard Disk Conversion \$50.00
 Post & Packaging \$10.00



BACK A WINNER! GO FOR META 4. ORDER DIRECT FROM: **SYSTEM SOLUTIONS PTY. LTD., 28-30 PALMERSTON ST, BERWICK VIC (03) 707 2851** OR FROM ANY OF THE FOLLOWING DEALERS:

VIC: ALPHAR & D (AUSTRALIA) 789 4658, COMPSOFT MICROCOMPUTER SERVICES (03) 428 5269, COMPUTERS 2000 (03) 781 4244, EMERALD HILL COMPUTER BROKERS (03) 690 8095, METROPOLITAN BUSINESS MACHINES (03) 383 2222, PRESIDENT COMPUTERS (03) 529 1788, ROBOCOON (AUSTRALASIA) (03) 429 5233

NSW: J.T. MICROCOMPUTER SERVICES (02) 848 0452, THE COMPUTER WORKS (06) 553 5485

QLD: MERMAID COMPUTERS (075) 35 5511

WA: COMPUTER AGE (09) 384 1111 SA: COMPUTER MARKETING HQ (08) 260 2444

Apple Users Society of Melbourne

BRAINDUMP

panies in the micro world in both hardware and software.

Initially the company is quite small and the quicker the product sells the quicker the company grows. As it expands the company takes on more and more staff until structure problems start to set in. At this point the company's founders decide it is time to restructure, using high-powered staff from an existing large corporation, whose attitude is 'give the customer what he wants'. The technical boffins go away and build yet another spreadsheet package, because the high-powered marketing men say this is what the customer wants. The point to remember is that if marketing men had been running, say, Visicorp at the beginning, VisiCalc would not have been released, because the potential buyers of VisiCalc would not have understood its diverse applications. Consequently, they would have turned to the market researchers and said: 'What do I need a matrix manipulation program for?'

The trouble with innovative applications programs is that often it's neces-

sary to build the product first and then let the users find their own applications later. This needs great faith (not to mention financial investment) in the product on the part of its producers.

Solutions

The answer to all these criticisms could be that it is all very well to talk about expanding micro horizons but these companies are in business to make money, not to invent unsuccessful new applications. This is certainly true, but you only have to look at the companies which are selling software today to see that the largest are the very companies which did the first pioneering work. There is a great advantage in being first into a new market sector.

Another obvious answer to the above is that it is not possible continually to invent new uses for micros, but if some of the large software companies were to spend more time and money investing in original research and less on making their version of someone else's product, we might all be better off.

A good example of this is the

so-called fifth generation software. For years people have been talking about expert systems, intelligent databases, knowledge engineering, and so on. Where are they all? I'll tell you where they are — they're in Japan and in the universities, and it won't surprise me one bit if some young graduate comes up with a truly original intelligent application. If he does he stands to make a fortune and it will serve today's software companies right if they get left behind.

All is not gloom though. Even if the large companies are slow to react there are still hundreds of small firms who are keen to fill the gap. A good example of this is the Brainstorm program (see *APC*, February 1983). It's possible that 'ideas processors' could be added to the list of business package types. It is too early to say now, but if this type of product has the same impact as, say, spreadsheets then I for one will be very happy.

END

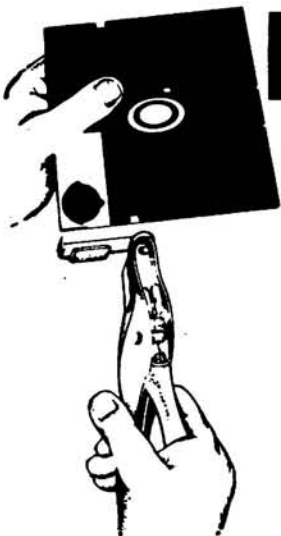

ORDER TODAY!

REDUCES DISKETTE COST 50%!
DOUBLES DISKETTE STORAGE SPACE

DEALER ENQUIRIES WELCOME

Owners of 5 1/2" single "READ/WRITE" head disk drives can immediately double diskette storage space by using NIBBLE NOTCH I and II. The back of single sided diskettes are burnished. To use it you need a "WRITE ENABLE NOTCH" and some also need in addition, an "INDEX HOLE". NIBBLE NOTCH I and II are precision engineered tools designed exclusively for this purpose.

NIBBLE NOTCH I

(Cuts square Write Enable Notch) For users of APPLE, ATARI, COMMODORE and most other soft sectored systems.

NIBBLE NOTCH II

(Cuts square Write Enable Notch and 1/4 inch round 'index hole') for owners of IBM, TRS 80 I & III, OSBORNE, KAYPRO and others needing "INDEX HOLE" and all other "HARD SECTORED" Systems.

Disk Optimizer® System for the APPLE II+, IIe (using emulator mode). Increases disk storage capacity, by using tracks normally occupied by DOS. Reduces file directory size. Verifies disk and removes bad sectors, disk drive speed check, etc.

Mail this form with payment to:

PROGRAMS UNLIMITED PTY LTD, 178 High St., Prahran 3181 (03) 529 6372 (03) 523 6311

Please supply me with: NIBBLE NOTCH I ONLY \$29.95 NIBBLE NOTCH II ONLY \$34.95
 Disk OPTIMIZER® SYSTEM \$35.95

I enclose Cash/Money Order/Cheque for \$

Name

Please debit my bankcard \$

Address

No.

P/code

Expiry date

Phone

Signature

Machine

add \$2.50 for postage and handling

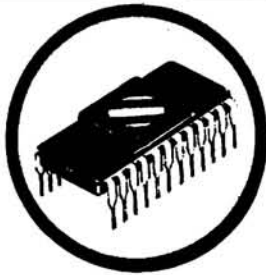

NEW GENERATION MICRO SERVICES

The personal computer back-up system you're been looking for. Unfortunately, most people find out the hard way that there's one question even a personal computer can't answer.

WHERE CAN YOU TAKE IT FOR SERVICE?

We have a suggestion. Come to our new service centre. right now we're equipped to handle:

Apple II, II+, IIe, III, Osborne, Commodore, Tandy, I.B.M. and all Apple compatibles. In addition Epson, Itoh and many other printers.

But in the future, we'll be servicing even more brands of personal computers and related items.

We're even providing a back-up system to our back-up system with a "Hot-line" to all the leading computer distributor service centres. So in the unlikely event that your Bugaboo baffles us there's extra help close at hand:

We also keep our parts well stocked. Which means your problem can be fixed a lot faster than you'd imagine.

But one of the best things about bringing your equipment to us is that you get quality personal service at a very affordable price. Pick-up and delivery available.

SERVICE CONTRACTS

We are also introducing a new type of service contract. The new contract is valued at 10% p.a. and 8% p.a. of total hardware cost for on-site and in-store respectively. In addition the contract will have a No-claim bonus system of up to 40% per annum.

The above contract includes a quarterly preventative maintenance on the system covered, FREE of charge. This ensures your system is operating to the manufacturers specifications.

WE OFFER

- ★ 24 hour turnaround on Apple II, II+, Apple disk drives and peripherals.
- ★ All original equipment repaired will carry a one month warranty.
- ★ Open on Thursday nights and Saturday mornings.

As an opening special for March and April — FREE Apple II, Osborne and I.B.M. disk drive alignments with every machine repaired or tested.

SCARLAN PTY LTD (Inc in N.S.W.)

T/A NEW GENERATION MICRO SERVICES

REAR 229 BURNS BAY ROAD, LANE COVE WEST 2066. Telephone (02) 427 0314



USER GROUPS INDEX

**DIRECT
ACCESS**

About a month ago we sent a letter to all User Groups which were in the last full listing (published in December, '83) asking for confirmation that the listing was correct. There were so many changes requested by the groups that we decided to bring the publication date back from the May issue to this issue in an effort to lessen the frustration of readers who are trying to contact groups where the telephone number, address or personnel of the group has changed. Our thanks to the large number of user groups which replied so promptly.

<u>NAME OF GROUP:</u>	<u>CATERING FOR:</u>	<u>MEETINGS:</u>	<u>CONTACT:</u>
NEW SOUTH WALES			
A.P.F. Users Group	A.P.F.	—	Norm Mc Mahon 288 Kissing Point Road, Turrumurra, 2074 (02) 44 2645
Ausborne User Group	Osborne	Every 3rd Wednesday of the month at 6.30pm at the North Sydney Council Chambers, 200 Miller Street.	Ian Stretton Napier Box C530 Clarence Street, Sydney 2000
Australian Unix Users Group	Unix	—	Chris Campbell P.O. Box 324, Pymble 2073 (02) 449 4400
Australasian ZX Users Group	Sinclair Computers — ZX80, ZX81 and Spectrum	—	Send S.A.S.E. to: P.O. Box 397, Dapto 2530 (042) 615 451
Broken Hill MicroBee Users Group	MicroBee	—	Peter Cotter 533 Radium Street, Broken Hill 2880 (080) 88 1621 After Hours
Compu-tech Computer Club	Commodore VIC-20, C-64 and PET	VIC-20 chapter meets 1st Tuesday of every month. C-64 and PET chapter meets 4th Tuesday of every month.	Geoff Rayner P.O. Box 115, Mayfield 2304
Hunter Users Group	General	Meets at University of Newcastle, Room W308 Education Building on the 2nd Wednesday of each month at 7.30pm.	Secretary, P.O. Box 39, Broadmeadow 2292
Illawarra Apple Core	Apple computer	Meets on the 4th Monday of each month at Holy Spirit College, Bond Street, Bellambi at 8pm.	Bob Williams (042) 96 6115
Illawarra Super 80 Users Group	Super 80	Meets on the 1st Monday of each month at 5.30pm at 86 Market Street, Wollongong	P.O. Box 1775, Wollongong 2500
MicroBee User Group	MicroBee	—	Eric Eulenstein 202 Kooba Street, Albury 2640 (060) 25 1601
Newcastle Microcomputer Club	General	Meets on the 2nd and 4th Monday of each month at 7.30pm in Room G12, Physics Building, University of Newcastle.	P.O. Box 293, Hamilton 2303 or Anthony Bliss (049) 67 2433 Tony Nicholson (049) 52 6017
NSW Peach User Club	Hitachi Peach	Monthly meetings are held on the 1st Saturday of each month. Contact them for location details	Daniel Soussi 37 Mooramie Street, Kensington 2033
Sydney Apple Users Group	Apple	Meets at the Sydney Grammar School Science Auditorium on the 2nd Monday of each month at 6.30pm	Frank Revill (047) 36 448

DO YOU OWN A COMMODORE 64?

REWARD \$1,000.00

CAN YOU WRITE APPLICATION PROGRAMS? We are offering a **\$1,000.00** reward for, what in our opinion, is the best Superbase application program.

We are offering the reward to the person or persons, or business that creates the best model from Superbase on the Commodore 64. Our only stipulation is that the superbase model must be created from a version of Superbase 64 originating from South Pacific Software.

You have 12 months from 1st January 1984 for the model program to be created. Superbase 64 is available from all South Pacific Software dealers.

Apart from our Superbase 64 program we have an extensive range of software.

**WORDPROCESSING,
MAILING, D-BASE**

Busiwriter
Busimailer
Vizawrite
Vizaspell
Superbase 64

PROGRAMMING AIDS

Data Handler
Arrow
Ezasm +Arrow
Graphix 64
Printlink
Petlink

**SPREADSHEETS &
ACCOUNTING**

Debtors
Creditors
General Ledger
Busicalc
Busicalc II

RECREATION

Air Traffic Controller
Code Master
Cosmic Capers
Cracks of Fire
Crazy Kong
Dungeons of Mulgoolie
Forestland
Goblin Towers
Halls of Death
Hunter Killer
Kaktus
Lord of Balrogs
Mangrove
Medicine Man
Music 64
Music Maker
Ninja

RECREATION

Say Simon
Shogun
Stix
Stompers
Streets of London
Tank Atak
Touch Typing Tutor
Weather War II
Worms
3D Gloopers
Ultrasprite
Ultrasynth
Super Pak
Treasure Pak
Games Pak
Edu Pak

We have possibly the LARGEST range of software packages for the Commodore 64 — with more programs to come!

Contact your nearest South Pacific Software dealer or write to:

**Catalogue Please, South Pacific Software
P.O. Box 155, Chippendale, NSW 2008**



N.S.W. The Microcomputer
VIC House Pty Ltd
S.A. 116 Abercrombie Street,
Chippendale 2008
(02) 698 7866

W.A. Vicwest
P.O. Box 182,
Tuart Hill 6060
(09) 444 3039

TAS Management
Technology
8 Montpelier Retreat,
Battery Point 7000
(002) 344 5222

QLD G.W.Sales
5 Eams Street,
Slacks Creek 4127
(07) 370 2056

USER GROUPS INDEX

<u>NAME OF GROUP:</u>	<u>CATERING FOR:</u>	<u>MEETINGS:</u>	<u>CONTACT:</u>
Sydney Forth Group	General	Meets at Room LG19, John Goodsell Commerce Building, University of NSW on 2nd Friday of each month at 7pm	Peter Tregaeagle 10 Binda Avenue, Yowie Bay 2228 (02) 524 7490 After Hours
T.I.S.H.U.G.	Texas Instruments TI-99/4 and other 16 bit TMS 9900-based personal computers	—	John Robinson P.O. Box 149, Pennant Hills 2120
The Blue Mountain Computer Club	General	Meetings are held at Springwood Civic Centre on the 2nd and 4th Friday of each month at 7.30pm	Eric Lindsay 6 Hillcrest Avenue, Faulconbridge (047) 512 258 After Hours
Wollongong Computer Club	General	—	P.O. Box 397 Dapto 2530 (042) 615 451

VICTORIA

Forth Interest Group	Forth	Meets on the 1st Friday of each month at 8pm. Contact secretary for details	Lance Collins, P.O. Box 103, Camberwell 3124 (03) 29 2600
Melbourne Atari Computer Enthusiasts Group	Atari	Usually held at the Rotunda at Monash University on the 1st Sunday of each month at 11.40am	Peter Coleman M.A.C.E. Secretary, P.O. Box 133, Mulgrave North 3170
Melbourne VIC-20 User Group	VIC-20	Meetings are held on the 4th Wednesday of every month at Box Hill TAFE Building No 4, 465 Elgar Road at 7.30pm	John Ruddock P.O. Box 252 Northcote 3070
Peninsula Group	General	Meets at the Frankston Library on the 2nd Tuesday of each month	M.G. Thompson (03) 772 2674
RCA VIP, ETI 660, Dream 6800 or Comx 35 Micros	RCA VIP, ETI 660, Dream 6800, Comx 35	—	Frank Rees 27 King Street, Boort 3537
Sorcerer Computer Users (Australia)	Sorcerer	—	Gordon Ohlenrott GPO Box 2402 Melbourne 3001
The Color Computer Club	TRS-80c Color Computer	Meets on the 1st Friday of each month at Geelong College at 8pm	Andrew Gay 3 Quamby Avenue, North Geelong 3215 (052) 78 3424
TI-99/4 Users Group Melbourne	TI-99/4	Meets monthly at Victoria College, Burwood	Wayne Worlidge 123 Ashburn Grove, Ashburton 3147 (03) 25 1832

ACT.

ACT Apple	Apple	Meets on the 2nd Thursday of each month	Eddie Tsui, Secretary P.O. Box 1231, Canberra City 2601
ACT VIC-20 Users Association	VIC-20	Meets each month. Details available from Association	Chris Groenhout 25 Kerferd Street, Watson 2602 (062) 412 316
ASUG	Sirius (Victor 9000)	—	Rob Judd 31 Altree Crescent, Phillip 2605
Canberra Micro-80 Users Group	TRS-80, System 80 and any other Z80 based microcomputers	Meets on the 3rd Monday of each month in the large lecture theatre of Building J, Canberra Technical College, Constitution Avenue, Reid at 7.30pm	M.J. Cottee 33 Crawford Crescent, Flynn 2615 (062) 58 8822
MICSIG			Registrar, MICSIG, P.O. Box E237, Old Canberra ACT 2600

USER GROUPS INDEX

<u>NAME OF GROUP:</u>	<u>CATERING FOR:</u>	<u>MEETINGS:</u>	<u>CONTACT:</u>
The Australian ZX Users Association	ZX80, ZX81 and Zx Spectrum Microcomputers	—	AZUA 19 Godfrey Street, Campbell 2601
QUEENSLAND			
Apple-Q Brisbane User Group	Apple	Meets every 3rd Sunday of the month at Hooper Education Centre, Kuran Street, Wavell Heights 8.30am — 4.30pm	David Bourne P.O. Box 721, South Brisbane 4101
Commodore Computer Users Group Queensland	Commodore	Meetings are held on the 1st Tuesday of the month at 7.30pm at Milton State Primary School, Bayswater Road, Milton	John Egan P.O. Box 274, Springwood 4127 (07) 287 2705
Cranium Computers	General	—	Chris Lucey 34 Lawless Street, Blackwater 4717
Ohio Superboard User Group	Ohio Scientific Microcomputers	—	Ed Richardson 146 York Street, Nundah 4012
Osborne Users Group	Osborne	—	Glen McBride (07) 371 4243 After Hours (07) 377 2763 Bus Hours
Peach Computer Users Group Queensland	All MB6890 users	Meets every 4th Tuesday at 7.30pm, Taringa Primary School, Brisbane	Leo Burke (07) 356 6080 or Brian Williams 19 Patrick Street, Norman Park
PC 1500/PC 2 Club	PC 1500 and PC 2 users	—	Mark Tischler P.O. Box 3, Wavell Heights, Brisbane 4012
S.C.C.U.G.	Commodore	Every Monday night at 7pm (ex school holidays), Labrador State School, Turpin Road, Labrador	Bill Fitzpatrick 5/19 Huth Street, Labrador 4215 (075) 32 0061
T.I.B.U.G.	TI 99/4 users	Meets 1st Friday every month	R-Saunders P.O. Box 57, Aspley 4034
Townsville MicroBee User Group	MicroBee	Meets at 7.30pm on the 2nd Monday of each month at Town & Country Computers, CTL Centre, Anne Street, Aitkenvale	John Johnson (077) 79 5628 After Hours
SOUTH AUSTRALIA			
MicroBee Users Group of South Australia	MicroBee	—	Brian Uren GPO Box 767, Adelaide 5001 (08) 260 5038
Sorcerer Users Group of South Australia	Sorcerer	Meetings are held on the 2nd Wednesday of every month at Adelaide University in the Eric Russel room of the Lower Napier Building	Don Ide 14 Scott Road, Newton 5074
IBM PC SA Users Group	All 8088 users are welcome	Meets on the first Thursday of each month at the location advertised in the newsletter	Don Richards P.O. Box 68, Walkerville 5081 (08) 261 9590
TRS-80 Users Group	TRS-80	—	R.G. Stevenson 36 Stuart Street, Adelaide 5000 (08) 51 5241 Bus Hours (08) 337 6682 After Hours
Adelaide Atari Computer Club	Atari	Meets at Gilles Street Primary School on 1st Monday of each month (2nd if 1st is on a public holiday)	N Pearce P.O. Box 333, Norwood 5067
Beebnet Inc	BBC & Econet users	—	P.O. Box 262 Kingswood 5062

“WHEN THE GOING GETS TOUGH . . .”

Its an unfortunate fact of “Hi-Tech” life that faults do develop, equipment components can fail, problems may arise — service back-up is required — FAST.

But frequently, the “big-talking” company that took so much trouble to sell you the equipment, cannot respond to your needs rapidly.

At best you find the after-sales service and support falls short of your requirements and expectations.

The safe alternative from Tech-Rentals:

- ✓ A unique “try before you buy” plan
- ✓ A choice of the most popular makes of computers and peripheral equipment including IBM, APPLE and HEWLETT-PACKARD
- ✓ The best maintenance and service support the industry can offer
- ✓ A guaranteed minimum downtime changeover
- ✓ Reasonable and competitive prices

IBM
Authorized Dealer
IBM
Personal
Computer



Consider, which of the above can you afford to delete?

Contact Tech-Rentals Pty Ltd on the **Hotline (03) 879 2266**
and we will explain our range of acquisition options.

HOTLINE (03) 879 2266

MELBOURNE:
12 Maroondah Highway,
Ringwood, Victoria 3134.
Phone (03) 879 2266.
Telex: AA 30418 ELTENT.

SYDNEY:
37-43 Alexander Street,
Crows Nest, NSW 2065.
Phone (02) 438 2199.



TECH-RENTALS PTY. LTD.
INCORPORATED IN VICTORIA

PERTH:
46-48 Kings Park Road,
West Perth 6005.
Phone (09) 322 1085.
Telex: AA 94765 AUSHOP.

AUCKLAND: -
P.O. Box 9564,
Auckland, New Zealand.
Phone (9) 50 4759.
Telex: 2451.

USER GROUPS INDEX

<u>NAME OF GROUP:</u>	<u>CATERING FOR:</u>	<u>MEETINGS:</u>	<u>CONTACT:</u>
Hitachi User Group	Hitachi	—	Geoff Drury 27 Creslin Terrace, Camden Park 5038 (08) 295 2778 After Hours
SA Microprocessor Group Inc	General	Meets at the Archery Association of Australia clubrooms, corner of Bundeys Road and War Memorial Drive, North Adelaide at 8pm, 2nd Friday of each month.	R.K. Matthews P.O. Box 113, Plympton 5038 (08) 296 3350 After Hours
TASMANIA			
Devonport Computer Interest Group	General	Meets 4th Thursday of each month. Contact group for location details	John Stevenson RSD 422, Sheffield 7306 (004) 92 3237
Tasmanian Computer Group	General	Meets 1st Tuesday of each month. Contact group for location details	Allan Appleby 17 Ninabah Street, Howrah 7018 (002) 30 2386 Bus Hours
TI 99/4 User Group	TI 99/4 users	Monthly meetings at the University of Tasmania, room 373, on every 3rd Sunday	Rex C. Shepherd 1 Benboyd Court, Rokeby 7019

New Zealand

ACES (Auckland Computer Education Society): C/- Director, Computer Centre, Secondary Teachers College, Private Bag, Symonds Street, Auckland. Meets 3rd Thursday, Teachers College, Epsom Avenue, Auckland.

ATARI Microcomputer Users Group: Ian Mason, 25 Manutara Avenue, Forrest Hill. Telephone: 467 347 (H). Meetings: 2nd Tuesday, Western Suburbs Radio Club, Gt North Road, New Lynn.

EPSON HX20 Users Group: C W Nighy. Telephone: 774 268. Meetings: 1st Wednesday, 231 Khyber Pass Road, Auckland.

HP41C Users Group (AK): Grant Buchanan. Telephone: 790 328 (W). Meetings: 3rd Wednesday, Centre Computers, Great South Road, Epsom.

NZ TRS-80 Microcomputer Club: Olaf Skarsholt, 203a Godley Road, Titirangi. Telephone: (09) 817 8698 (H). Meets 1st Tuesday, OSNZ Hall, 107 Hillsborough Road, Mt Roskill.

OSI Users Group (AK): Ken Hartley, 77 Boundary Road, Blockhouse Bay. Meets 3rd Tuesday at the VHF Clubrooms, Hazel Avenue, Mt Roskill.

Christchurch '80 Users Group: Brendon Thompson, P.O. Box 4118, Christchurch. Telephone: (03) 370 381 (A.H.).

Nelson Commodore Users Group: Peter Archer, P.O. Box 860, Nelson, NZ. Telephone: (054) 79 362.

NZ PC 1500 User group: Allan Thomas, P.O. Box 155, Napier, NZ.

Taranaki Microcomputer Society: Keith Smith, P.O. Box 7003, Bellblock, New Plymouth, NZ. Telephone: Waitata 8556.

NZ Microcomputer Club Inc: P.O. box 6210, Auckland. Monthly meetings the 1st Wednesday of each month at 7.30pm at the OSNZ Hall, 107 Hillsborough Road, Mt Roskill.

The following User Groups are part of the NZ Micro Club, all meetings start at 7.30pm.

APPLE Users Group: Ross Bryon. Telephone: 761 670 (H). Meetings: 3rd Tuesday each month at the OSNZ Hall, 107 Hillsborough Road, Mt Roskill.

BBC Users Group: Dave Fielder. Telephone: 770 630 Extn 518 (W). Meetings: 2nd Wednesday at the VHF Clubrooms, Hazel Avenue, Mt Roskill.

BUSINESS Users Group: Cathy Arrow. Telephone 491 012 (H). Meetings: 4th Tuesday each

month. Even months at the VHF Clubrooms, Hazel Avenue, Mt Roskill. Visits to business compute establishments are arranged for odd months.

CP/M Users group: Kerry Koppert. Telephone: 695 355 (H). Meetings: 1st Wednesday 9pm (after the Club meetings) each month at the OSNZ Hall, 107 Hillsborough Road, Mt Roskill.

IBM PC Users Group: Terry Bowden. Telephone: 452 639 (H), 778 910 (W). Meetings 3rd Thursday each month at the OSNZ Hall, 107 Hillsborough Road, Mt Roskill.

NZ COMMODORE Users Group (AK): John Walker. Telephone 8339 589, P.O. Box 5223, Auckland. Meetings: 3rd Wednesday each month at the Remuera Primary School Hall, Dromorne Road, Remuera.

NZ Microcomputer Club Inc: Selwyn Arrow (Chairman). Telephone: 491 012, P.O. Box 6210, Auckland, (See above for full details).

NZ OSBORNE Users Group (MZOG): Brian Jones. Telephone 659 738 (H). Meetings: 1st Thursday each month at 20 Kingsley Street, Grey Lynn.

POCKET COMPUTER Users Group: Peter Taylor, 14 Gollan Road, Mt Wellington, Auckland 6. Telephone: 576 618 (H).

SINCLAIR Users Group: Doug Farmer. Telephone 567 589 (H). Meetings: 4th Wednesday at the VHF Clubrooms, Hazel Avenue, Mt Roskill.

SORCERER Users Group (NZ): Selwyn Arrow. Telephone: 491 012 (H). Meets 1pm at Saturday Micro Workshop (see above).

SORD Users Group (NZ): Graeme Hall, 5 Brouder Place, Manurewa. Telephone: 266 8133 (H).

TI 99/4A Users Group: Ray Tucker. Telephone: 568 155 (H).

ToMorrow Users Group: Chris Cotton. Telephone: 789 153. Meetings: 3rd Thursday, 20 Kingsley Street, Grey Lynn. BYO floppy disk.

WIZZARD Users Group: Richard McFadgen, 11 Hilling Street, Titirangi. Telephone: 8178 219 (H).

1802 Users Group: Brian Conquer. Telephone: 695 669 (H).

2650 Users Group: Trevor Sheffield. Telephone: 676 591 (H).

68xx(x) Users Group: John Kucernak. Telephone: 606 935 (H).

All the above use the Micro Club's postal address.

THE SALE YOU CANNOT REFUSE

VECTORIO-64Z TWO-IN-ONE 6502 +Z80 FOR CP/M APPLE COMPATIBLE

CENTRAL CPU, 6502 & Z80
64K BYTE OF USER RAM
MEMORY
FULLY PROGRAMMABLE
KEYBOARD 54 PRE-
PROGRAMMED KEYS
NUMERIC KEYPAD
SPECIAL FUNCTION KEYS
UPPER AND LOWER CASE
FULL GRAPHICS 280X192
RESOLUTION
7 EXPANSION SLOTS
WILL RUN APPLE AND CP/M
SOFTWARE
#3 MONTHS GUARANTEE
FULL IN HOUSE SERVICE
AND SUPPORT.

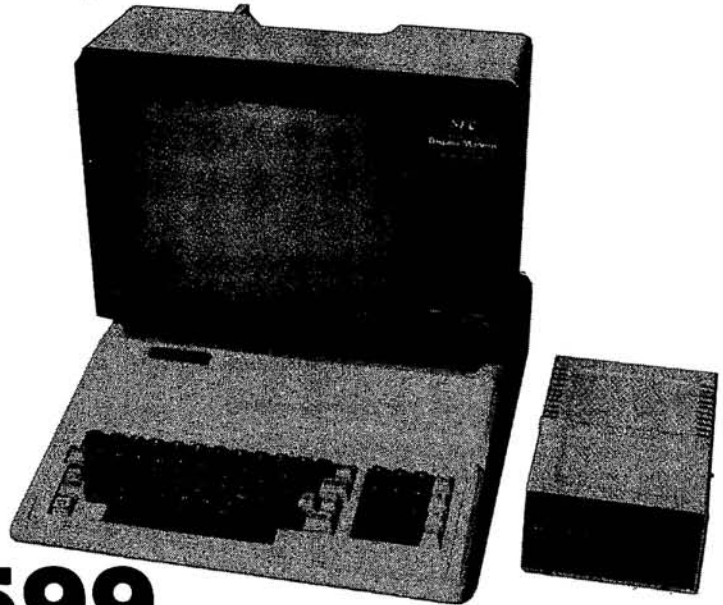

TELEPHONE: (03) 568-6911

\$599 TAX PAID
COMPUTER ONLY

★★SPECIAL★★ COMPUTER, MONITOR, DISK DRIVE, CONTROLLER AND ALL CABLES

TOTAL PRICE \$1075 TAX PAID
THIS MONTH ONLY

TELEPHONE 03 568-6911

MICRO PRO COMPUTERS

43 ATHERTON RD
OAKLEIGH 3166
MELBOURNE AUST

PLEASE FIND ENCLOSED CHEQUE

FOR THE AMOUNT OF \$.....

FOR THE FOLLOWING.....

PLEASE SEND ME MORE INFORMATION

NAME.....

ADDRESS.....

SUBURB.....

STATE.....

PERIPHERAL CARDS

192K virtual disk.....	\$300.00
80 column interface card to suit Apple.....	\$90.00
40/80 soft switch to suit above.....	\$20.00
Centronics print I/Face.....	\$60.00
Grappler interface and cable.....	\$82.00
Z80 cpm interface card.....	\$60.00
16K ram card.....	\$72.00
DISK DRIVE CONTROLLER.....	\$55.00
Eprom burners.....	\$80.00
8" disk drive controller cables 1.2mg storage includes software PASCAL CP/M DOS.....	1080
Pal card.....	\$68.00

**COME TO OUR LARGE SHOWROOM
TO SEE OUR DISPLAY**

Full service and warranty work done on premises

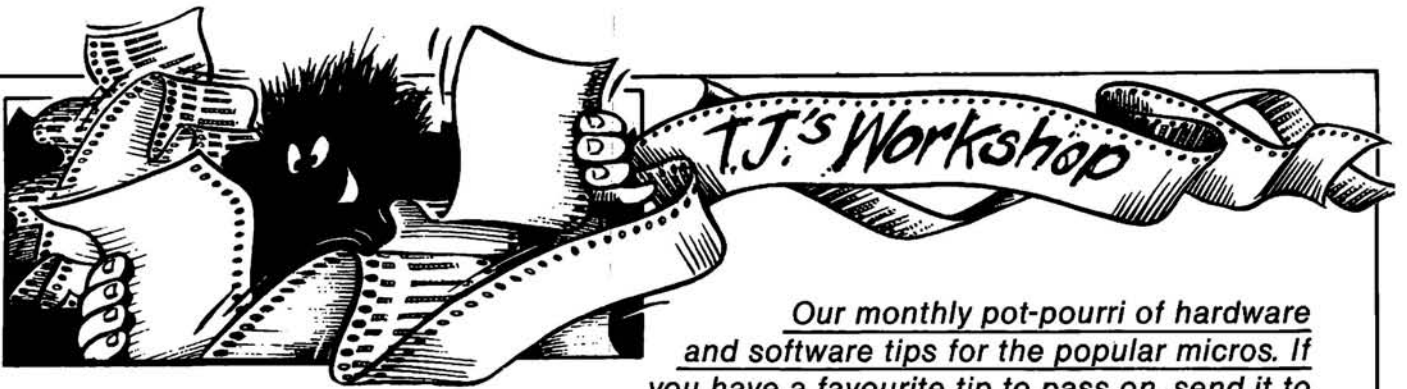

Our monthly pot-pourri of hardware and software tips for the popular micros. If you have a favourite tip to pass on, send it to

'TJ's Workshop', 77 Glenhuntly Road, Elwood, Victoria 3184. Please keep your contributions as concise as possible. We will pay \$10—\$30 for any tips we publish. APC can accept no responsibility for any damage caused by using these tips, and readers should be advised that any hardware modifications may render the maker's guarantee invalid.

System 80 multiple USR calls

Here is a useful method for calling machine code sub-routines from Basic on the System 80 which cuts out the need to use two pokes before the routine can be called.

To use a USR machine code routine the address must be POKEd into locations 16526 and 16527. This is alright if there is only one routine but if there are two or more the

time taken to POKE the new address before each call is very much wasted and also uses more memory than is necessary.

The first thing to do is set up the following routine anywhere in memory. (I usually just tag it onto the end or the beginning of one of the machine code routines.)

```
CALL 0A7FH
JP HL
```

Then POKE the address of the above CALL instruction into locations 16526 and 16527. For example, if the CALL were at 32000 decimal then you would POKE 16526,0 : POKE 16527,125.

To call any routine in memory use X=USR(N) where N is the start address of the routine; say, the routine is at 7F00H then use X=USR(32512).

This method is particularly useful for a type of ON n GOSUB to a machine code routine. To set this up put the addresses of the routines in an array — for example, A(1)=32000 A(2)=32123. Then use X=USR(A(I)) where I is the number of the routine.

The problem with this method is that you cannot pass an argument to the routine. The best way round this, and the method I prefer, is to define which

variables you are going to use at the beginning of the program as integer, and then use the VARPTR command to find the address of these variables and POKE these directly into the machine code.

```
For example,
10 defintA
20 X=VARPTR(A)
:POKE32001,
(X-(INT(X/256)*256))
:POKE32002,INT(X/256)
```

Then in the machine code 7D00H LD HL,(ADDR);line 20 above pokes the address of variable A into ADDR.

W Burgar

VIC game controllers

I read with interest 'Joyful VIC' in October TJs on how to incorporate the use of a joystick into programs. There is one major problem with the routine. It is in machine code, and so a monitor is needed.

```
Joy-vic      fire=128
10PRINT"(SHIFT/CLR)"
20PRINT"JOY-VIC":PRINT
"BYCMURRAY"
30DIMC(2,2):POKE
37139,0:A=37154:B=37152
40FORJ=OTO2:
FORI=OTO2:READC(I,J):
NEXT I,J
50DATA7,0,1,6,8,2,5,4,3
60GOSUB9000:1FR=1THENPRINT"128":GOTO60
```

Here are two routines which should be used inside programs to enable the use of either the paddle or the joystick.

The programs come in two parts. Lines 10-50 are initialisation; the rest of the program can be called as a subroutine whenever you want to read the joystick/paddle.

```
0
7 ! 1
6 — 8 — 2
5 ! 3
4
```

```
70PRINTC(X+1,Y+1):GOTO60
9000POKED,127:E3=-((PEEK(B)AND128)=0)
:POKED,255:P=PEEK(A)
9010E1=-((PAND8)=0):E2=-((PAND16)=0):EO=((PAND4)=0):
9020FR=-((PAND32)=0):X=E2+E3:Y=EO+E1:RETURN
Vic-paddle
10PRINT"(SHIFT/CLR)VIC-PADDDLE"
20PRINT"BYCMURRAY"
30POKE37139,0:D=37154:A=37137:B=37152
40ZX=36872:ZY=36873
50GOSUB9000:PRINTPEEK(ZX):PEEK(ZY):X:Y:GOTO50
9000POKED,127:Y=-((PEEK(B)AND128)=0):POKED,255
9010X=-((PEEK(A)AND16)=0):RETURN
```

C Murray

Spectrum double-height listings

The ZX printer is an excellent little machine but

often the print suffers from fading lines. Sometimes this can be so bad that program listings, especially long lists of data, can be almost unreadable in parts. The program described here avoids these problems by printing listings in double-height

characters, so that when fading occurs it is much easier to recognise what the characters are supposed to be.

The task of producing double-height characters from string variables can be accomplished fairly easily using Basic and user-defined graphic characters. Producing listings of program lines, however, is not quite so easy, since there are many non-text control characters embedded within each line, and so we have to resort to using machine code.

The program works by printing each line in turn at the top of the screen and then uses a modified version of the COPY command to print two pixel lines on the printer for each single pixel line on the screen. The screen is cleared and the process repeated until the last line has been printed. This method uses the normal Spectrum listing routine to remove all the control characters from the line to leave a text-only copy of the line on screen, which is then printed. One limitation of the program should also become apparent here: lines that occupy more than one full screen will not be printed properly. However, since the use of such long lines is not recommended, this is no real problem. (Have you ever tried to edit a program line of 10-15 lines? Slow is not the word!)

The code is fully relocat-

able, simply change the initial CLEAR and LET x= statements to any number you require; to avoid overwriting your own machine code. For example, the listing is set for a 16k Spectrum, making the code sit just below the first user-defined graphic, but will work on any machine size. Simply enter the Basic, RUN it once and then the machine code is in place, protected from NEW, LOAD, and so on. The Basic program can be safely removed or overwritten.

To use the program, RANDOMISE USR 32524 (or your own new number) will produce a listing of the whole program on the printer. As each line is printed it appears on the screen. To stop any listing, simply press BREAK at any time.

The program may also be used to produce double-height copies of any screen image the user wishes, by printing a user-defined number of pixel lines from the top of the screen. Whatever has been printed or plotted there by Basic will appear in double-height on the printer. To do this, POKE 32521,n where n is the number of pixel lines (remember: a full screen is 176 lines, one character line is eight pixel lines and so on) and RANDOMISE USR 32520.

G Wilson

Assembly Listing of Program

```

entri1:   lda,1           ;entry for pixel lines
          jrmain         ;jump to main prog
entrie2:  ld hl,(prog)    ;entry for llist, point hl
          push hl        ;at prog start and save it.
loop:     call clrall     ;monitor. clear the screen
          pop hl         ;pointer to current line
          ld a,(hl)      ;check that we have not
          and 192        ;finished listing whole prog
          ret nz         ;return to basic if so.
          call nextone   ;monitor. else point de at
          push de        ;line and save it
          call outlin    ;print the current line
    
```

```

ld hl,(sposnl) ;point to last screen line
lda,25         ;printed, and adjust to range
sub (hl)       ;1 to 24 (from top of screen)
add a,a        ;mult*8 for no. of pixel lines
add a,a        ;in one character line
main:         ld b,a           ;copy to b for loop.
              di              ;for the printer.
              ld hl,d-file    ;hl=first pixel line
cpy1:         push hl         ;save pixel line pntr
              push bc         ;save pixel line counter
              push hl         ;save each twice
              push bc
              call cpylin     ;monitor. copy one pixel line
              pop bc          ;to printer. restore pointers
              pop hl         ;and copy same line again, ie
              call cpylin     ;print each line twice.
              pop bc          ;restore pointers
              pop hl
              inch           ;now adjust hl to point at next
              lda,h          ;pixel line
              and 7          ;if <7 then simply h=h+1
              jr nz,cpy2     ;jmp to continue loop
              lda,l          ;else adjust hl depending on
              add a,32        ;which third of the display file
              ld l,a         ;it lies
              ccf
              sbca,a         ;and 248
              and 248
              add a,h
              ld h,a
cpy2:         djnz cpy1      ;dec pixel counter and loop if
              lda,4         ;unfinished lines still
              out (251),a    ;else stop printer motor
              ei
              jr loop        ;and loop back to main loop
    
```

OK,

```

.5 CLEAR 32519: RESTORE : LET y=32320
.6 REM set for 16k Spectrum. Use any number you prefer
.7 READ x: IF x(<)-1 THEN POKE y,x: LET y=y+1: GO TO 7
.8 FOR n=3759 TO 3763: POKE y,PEEK x: LET y=y+1: NEXT x
.9 FOR n=3762 TO 3768: POKE y,PEEK x: LET y=y+1: NEXT x
.10 FOR n=3764 TO 3785: POKE y,PEEK x: LET y=y+1: NEXT x
.11 .40 READ x: IF x(<)-1 THEN POKE y,x: LET y=y+1: GO TO .40
.12 .80 DATA 62.1.24.28.42.83.92.229.285.175.13.225.126.238.
.13 192.192.205.184.25.213.
.14 285.85.24.33.137.92.62.25.158.135.135.135.71.243.-1
.15 210 DATA 224.62.4.211.251.251.24.188.-1
.16 480 STOP
.17 450 REM ***** use the program
.18 500 POKE 32521,4: RANDOMISE USR 32520: REM print top 4
.19 (for example) pixel lines on screen.
.20 510 RANDOMISE USR 32524: REM LIST entire program
    
```

64 characters walking tall

One of the facilities missing on the Commodore 64 is the ability to print double height letters. I have included a routine that will allow you to print the first six letters of the alphabet in double height. With a few adjust-

ments, you can print up to 127 double height ROM characters.

The loop in line 4 (using l), is the loop telling the computer how many letters are wanted to be copied. By changing the loop number and the data statements in line 10 you can choose the letters you want, e.g. if you want to print the letters a-f and @, in double height,



then change line 4 to:
 4 Z=12288:FOR 1=0 TO
 6:READ D:D=(D*8)+53246)
 :FOR L=0 TO 7:
 A=PEEK(D+L)

then add a 'O' to the data
 statements:
 10 DATA 0,1,2,3,4,5,6
 Line 5 is important
 because:

1) It checks the current loca-
 tion used for your new
 character set is not equal to
 a "", then the computer is
 told to jump to the next
 usable location (\$).
 2) Because you cannot print
 a "" on the screen, it would
 be pointless if you defined
 the (shift/2) key, so line 5
 jumps this location.

To use your new character
 set, use POKE53272,
 (PEEK(53272)AND240)+12:

To print each double
 height letter you have to
 type the corresponding key
 to the character wanted,

then the next symbol, found
 by using the screen display
 codes on pages 132-133 in
 the CBM 64 users guide.

To print the letters in the
 example use:

@BDFHJ
 ACEGIK

NB The data statements
 use the screen display codes
 on pages 132-133 in the
 CBM 64 User's Guide.

```

1 POKE 52,48:POKE56,48:CLR
2 POKE 56334,PEEK(56334)
  AND254
3 POKE 1,PEEK(1) AND 251
4 Z=12288:FOR 1=0 TO
5:READ
  D:D=((D*8)+53248):FOR
  1=0
  TO7:A=PEEK(D+L)
5 IFZ=(34*8)+12288 OR
  Z=((128+34)*8)+12288 THEN
  Z=Z+8
6 POKE Z,A:POKE
  Z+1,A:Z=Z+2:NEXTL,I
8 POKE1,(PEEK(1)OR4)
9 POKE56334,PEEK(56334)
  OR 1
10 DATA 1,2,3,4,5,6
  
```

G Hutchings

Rooting around in graphics routines

Square rooting is especially
 useful in graphics routines
 when plotting trajectories or
 using Pythagoras to find dis-
 tances. However, when
 graphics routines are con-
 verted to machine code it
 seems that this useful func-
 tion has to be forfeited.

To get around this a table
 could be set up, but the
 following algorithm is much
 more compact. It gives the
 nearest integral (whole
 number) answer, ideal for

graphics routines.
 Tim Love

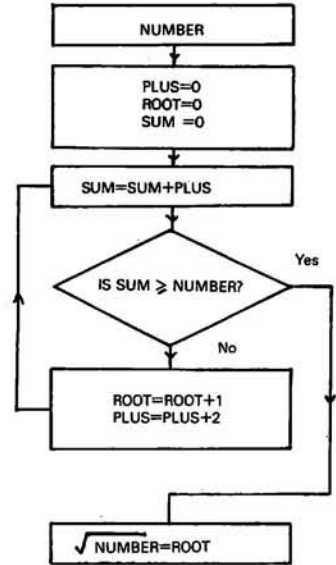

From A to Z with care

The following program can
 be used to practise touch
 typing. Just type in the
 letters A to Z in order. If you
 get one wrong the machine
 will beep.

```

10 CLS
20 FOR T=65 TO 65+25
30 A$=INKEY$:
  IF A$="" THEN 30
35 IF A$=CHR$(27)
  THEN MENU
40 IF ASC(A$)>T THEN BEEP:
  GOTO 30
50 PRINT A$:
60 NEXT
70 PRINT
80 GOTO 20
  
```

K Grant

Reward routine for arcade games

The following is a short
 machine code routine for the
 Commodore 64 home com-
 puter. It is the ideal graphic
 reward for gaining an extra
 life, for example, and is well
 worth typing in if only for a
 look.

After you have typed in
 the program and run it a few
 times, to get the same effect
 on the border type, as a
 direct command or other-
 wise, POKE 79163,33.
 Alternating between these
 two versions can produce
 nice effects indeed, for
 example:

```

9999 SYS49152:POKE49163,32:
SYS49152:POKE 49163,33:
GOTO 9999
  
```

This sort of thing could be
 used in arcade programs to
 show you've hit the mother
 ship, or that you're going on
 to the next level etc.

While the routine is being
 executed (either version)
 hold down a key. Even nicer
 eh! Unfortunately I could not
 produce this without having
 a key pressed.

D Rossiter

```

5 COUNT=0
20 DATA 0,222,144,0,164,0,166,0,
  232,76,22,192,142,33,206,
  229,0,240,3,76,6,192,96
30 DATA 234,164,0,200,234,196,0,
  240,3,76,24,192,76,10,
  192,0,0,0,-99
40 READ D
50 IF D=-99 THEN 100
60 POKE SA+COUNT,D
70 COUNT=COUNT+1
80 GOTO 40
100 PRINT"CLEAR SCREEN"
  FINISHED TYPE 'SYS
  49192' TO GO*
110END
  
```

TRS-80 Model 4 CPM

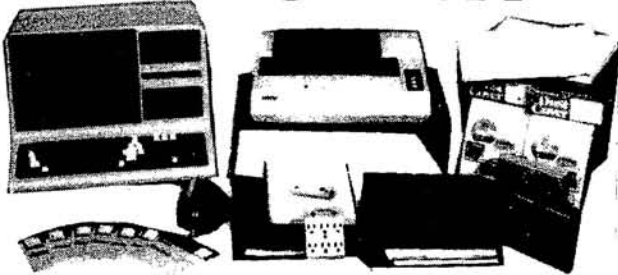

CPM OPERATING SYSTEM INCLUDES ...

- Disk Interchange Format ability to copy 20 other manufacturers' disk formats.
- Memlink uses extra memory as a solid state disk drive.
- Emulates ADM3A Terminal.
- Full Australian Integrated Accounting Software available separately for \$600.
- Supplied with all Digital Research utilities.
- Makes the Model 4 able to run all CPM Industry standard software.

ONLY **\$250**

deForest Computers
 26 STATION ST., NUNAWADING, VICTORIA 3131.
 TELEPHONE (03) 877 6946 • TELEX AA 30625

Flags flying on the Z80

Here is a tip for Z80 programmers. At some time, you may find that you need to manipulate the flags register. This is usually done using the set, reset and bit instructions (for looking). The trouble comes when you want to alter the flags. The

following sequence should help:
 PUSH AF; Store AF on stack
 POP BC; Load BC from stack, getting AF in process.

Manipulate C as required since it contains the Flag register.
 PUSH BC; Stack BC
 POP AF; and return to Flag reg NB: BC can be any of the double registers.

Graham McConney

Spectrum key considerations

When writing an educational program or a program for users not familiar with the Spectrum quirks, a 'Press any key' routine can be puzzling if it does not recognise every key: 10IF INKEY\$="" THEN GOTO10 does not recognise any of the shift keys.

This can be resolved using 'IN' statements as shown

below. This will recognise all keys and can be incorporated into your own programs.

(Note that some Spectrums may need to alter line 110 so that 65278=190 and 32766=189 KG).

```
100 PRINT "Press any key"
110 IF INKEY$<>"" OR IN
65278=254 OR IN 32766=253
THEN GOTO 200
120 GOTO 110
200 PRINT "Key pressed"
```

Peter Dans

Commodore 64 frozen display

When listing a program on the Commodore 64, you can slow down the display by pressing the CTRL key. The following short program adds the facility to freeze the display by pressing the SHIFT OR SHIFT LOCK keys. Run the program and

then type NEW (RETURN) load your program and type LIST (RETURN). Pressing the shift key will now freeze the listing.

```
10 REM PAUSE ROUTINE
20 FOR I=49152 to
49161:READ A:
POKE I,A:NEXT
30 DATA 72, 173, 141, 2,
208, 251, 104, 76, 26,
167
40 POKE 774, 0:POKE
775, 192:END
```

Brian Rutherford

Run a 64 program with three keys

Most Commodore 64 users know that pressing a letter then shift with RUN/STOP runs a program.

There is a three key version of this routine which

can be more useful.

If you press down the shift key with the number 4 and then 2, this also runs the program and if you press down the SHIFT 4 and 2 keys simultaneously this will load in the next program on tape. There may be a few other variations with these keys that you can find with a little experimenting.

G Wyn Jones

Reformed Commodore characters

The following machine code routine can be used for redefining the character set in bank 0 (14363-16383). I chose this set as it is the highest in the bank therefore leaving the most memory free. It is possible to use different banks but this means moving the screen to a new

part of the memory and this may complicate programs.

The usual Basic program takes about 35 seconds whereas this is almost instant.

To use it type SYS 49152. It is relocatable so to move it, change the variable in line 10.

To turn on the graphics type POKE 53272,31 to turn them off type POKE 53272,21. (NB: Make sure the computer is in upper case).

J Marsden

```
10 S=49152
20 READ A
30 IFA=-1 THEN END
40 POKES,A
50 S=S+1
60 GOTO 20
100 DATA 173,14,220,41,254,141,14,220,173,1,0,41,251,141,1,0
110 DATA 162,0,189,0,208,157,0,56,189,0,209,157,0,57,189,0
120 DATA 210,157,0,58,189,0,211,157,0,59,189,0,212,157,0,60
130 DATA 189,0,213,157,0,61,189,0,214,157,0,62,189,0,215,157
140 DATA 0,63,232,208,205,173,1,0,9,4,141,1,0,173,14,220
150 DATA 9,1,141,14,220,162,56,134,52,134,56,96,-1
```

ATARI 800XL

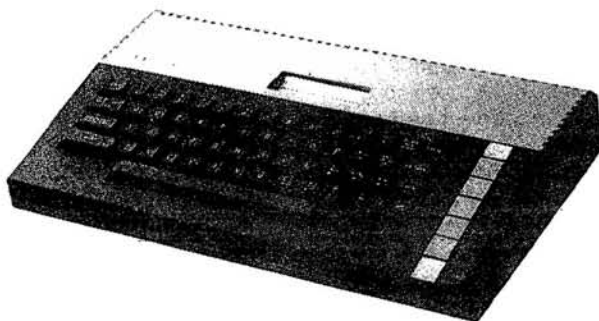

ATARI 1050 DISK DRIVE and 1020 COLOUR PLOTTER also available
 PHONE NOW AND PLACE YOUR ORDER WITH AUSTRALIA'S OLDEST ATARI DEALER.

FOR SUPPORT GO WITH THE EXPERIENCED DEALER

CALCUTRONIC PTY LTD
 CALCULATOR AND COMPUTER CENTRE
797 GLENFERRIE ROAD,
HAWTHORN, VIC 3122
Telephone: (03) 818 6631



64 screen dump — in black and white

The following short listing for the CBM 64 dumps the screen display to the Commodore printer. Although a program to do this is given in the CBM printer manual, it will not produce characters

generated by reverse video.

This program will reproduce all CBM characters and is also shorter and, I believe, more efficient.

If a graphic screen is to be copied then the CHR\$ value in 60030 should read 8.

This is a short listing and should ideally be used as a subroutine within the main program. Conversion to the VIC-20 will require alterations to lines 60010 and 60105.

K Twinbarow

```

60000 REM*****SCREEN DUMP*****
60001 REM****      ****
60002 REM***BY D.K.TWINBAROW***
60010 AT$=""
60020 F=0: DIMAS$(80)
60030 OPEN#4: PRINT#4, CHR$(15)
60100 FOR X=1024 TO 2023 STEP 40
60105 FOR S=0 TO 39
60110 CH=PEEK(X+S)
60120 IF CH=0 AND CHC=31 THEN AS$(S)=AS$(S)+CHR$(CH+64)
60130 IF CH=32 AND CHC=63 THEN AS$(S)=AS$(S)+CHR$(CH)
60140 IF CH=64 AND CHC=95 THEN AS$(S)=AS$(S)+CHR$(CH+32)
60150 IF CH=96 AND CHC=127 THEN AS$(S)=AS$(S)+CHR$(CH+64)
60160 IF CH=128 THEN CH=CH-128: AS$(S)=AS$(S)+CHR$(18): F=F+1: GOTO 60120
60170 IFF=1 THEN AS$(S)=AS$(S)+CHR$(146): F=0
60180 AT$=AT$+AS$(S): AS$(S)=""
60200 NEXT S
60210 PRINT#4, AT$
60220 AT$="": NEXT X
60230 CLOSE#4: RETURN
  
```

HX20 random number seed

The following routine for the HX20 can be used to produce a random number seed at the start of a Basic program. The routine uses the internal timer, locations &H0009 and &H000A, to provide an integer in the range -32768 to +32767.

The timer counts from 0 to &HFFFF and then resets to zero again. This process takes 107 milliseconds and so there are approximately nine complete count cycles per second.

```

10 POKE &H7E, (&H80 OR PEEK(&H7E))
20 RANDOMISE 256*PEEK(&H9) + PEEK(&HA) - 32768
30 POKE &H7E, (&H7F AND PEEK(&H7E))
40 REMAINDER OF PROGRAM FOLLOWS
  
```

J Wald

Commodore 64 text reverse

A useful function for the Commodore 64 would be a method of seeing at a glance the difference between screen prompts and data input by the user. While colours can be used to do this, a more visually effective

way is to reverse text. This can be done simply by including POKE 199, 1 before an INPUT statement as in the example shown.

The reverse text is automatically cancelled by the return following the input of data.

```

10 PRINT "INPUT:DATA"
20 POKE 199, 1: INPUT AS$
30 PRINT "<2 CURSOR UP>"
40 GOTO 10
  
```

Brian Rogers

Experiment with Atari colour

The subroutine shown enables you to select any of the colour registers (0-4) and alter the colour value held there. The machine code routine is loaded into page 6 of the RAM and set up to execute within the vertical blank interrupting procedure.

After enabling the routine by GOSUB 9400, you can alter the colours by pressing

the console keys:

OPTION — selects the next colour register.

SELECT — increases the colour value.

START — decreases the colour value.

Once the routine is installed you should be able to use the machine normally and run other programs (providing they don't use the three function keys, page 6 RAM or their own VBI routine). Thus you can experiment with the colours produced by program displays.

Nick Pearce

9399 REM*** setup console keys as colour selectors ***

```

9400 FOR I=1539 TO 1627: READ J: POKE I, J: NEXT I
  
```

```

9420 POKE 1537, 5: REM response 1=fast
255=slow
  
```

```

9440 POKE 1538, 4: REM first colour reg selected
  
```

```

9450 K=USR(1608): REM enable
  
```

```

9460 REM to disable use K=USR(1618) or press RESET
  
```

```

9490 RETURN
  
```

```

9500 DATA
  
```

```

206,0,6,208,61,173,1,6,141,0,6,173,31,208,201,3
  
```

```

9510 DATA
  
```

```

208,17,238,2,6,173,2,6,201,5,208,33,169,0,141,2
  
```

```

9520 DATA
  
```

```

6,240,26,174,2,6,201,5,208,9,254,196,2,254,196,2
  
```

```

9530 DATA
  
```

```

24,144,10,201,6,202,11,222,196,2,222,196,2,196,16,141
  
```

```

9540 DATA
  
```

```

31,202,76,98,228,104,162,6,160,3,169,7,7,6,92,228
  
```

```

9550 DATA
  
```

```

104,162,228,160,98,160,7,76,92,228
  
```

Apple POKEs

While speaking to a few friends about "mug traps" on the Apple II micro-computer, I picked up a few tips which I think may be useful to readers of APC whose disks may sometimes

be borrowed without their permission.

POKE 50,128 — If you read in the HELLO program, the catalog and the listing of any program of any disk read thereafter will become invisible. If 128 is replaced by any number from 1 to 255, the catalogs and listing

T.J.'s Workshop

read thereafter will become scrambled.

POKE 214,255 — Anything (but DOS commands) which is typed into the computer will be the same as typing RUN. So far I have not found a way of nullifying this POKE, except by turning off the computer.

POKE 2049,1 — This POKE shows only the first

line of any program listing read thereafter.

POKE 1011,213 — This makes RESET re-boot the system.

POKE 44599,234 — No catalog will be read from a disk after this POKE is read by the computer.

M Sabic

SYSing around on your VIC-20

When I was using my friend's computer I discovered some useful sys's. Here is a sample of them.

— sys24000 disables the whole keyboard

- sys64802 resets the computer and "news" any program
- sys49152 starts routine in a program
- sys25000 disables the keyboard
- sys26000 disables the keyboard

A Meissner

VIC key repeat

Commodore VIC-20 owners may find this POKE useful. It enables you to have full keyboard repetition with the exception of the function keys. The command comes in quite handy in games that

require key control as it allows faster movement.

The command is:
POKE 650, 129

Note that anything above 128 will enable the keyboard and anything below will restore the VIC to normal.

D Crocker

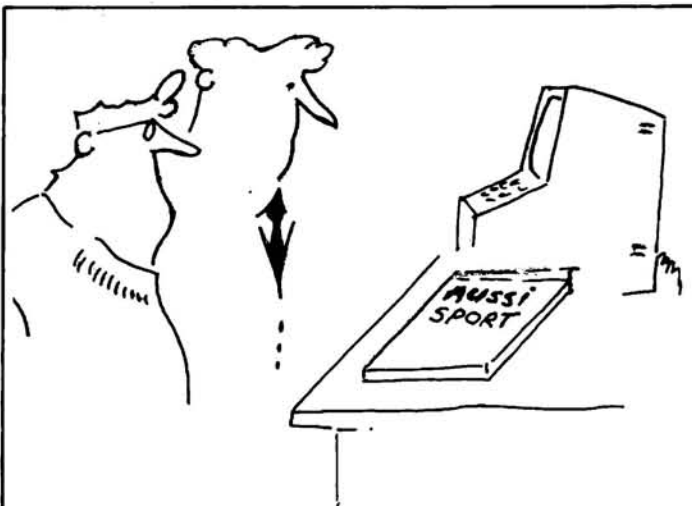

'It's so authentic Bob Hawke presents the prize.'

PRENTICE-HALL

BOOKWARE™

IBM-PC Assembly Language

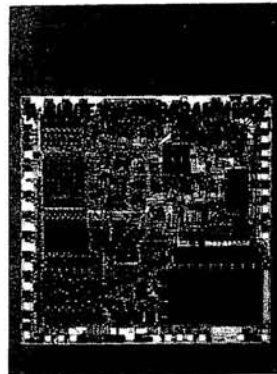

Leo Scanlon

An introduction to the 8088 microprocessor, numbering systems, and assemblers. Easy-to-read and understand, the book outlines the steps necessary for creating and running assembly language programs. Details the entire instruction set of the 8088 microprocessor. Some programming experiencing (in any language) required.

311 pp / \$31.50 rrp

Learning Lisp

Gnosis

New!



A tutorial introduction to Lisp, a language developed at MIT for work in artificial intelligence. The book covers the basic data structure and functions, explores in detail the concept and different uses of recursion, and outlines advanced Lisp techniques.

199 pp / \$23.95 rrp

Personal Pascal

David Cortesi & Cherry George

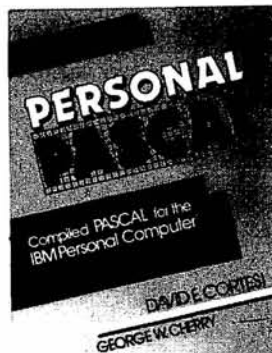

A complete exploration of the computer programming language Pascal. Covers non-standard language features unique to the two Pascal compilers on the IBM-PC. All exercises and examples can be carried out on the reader's computer.

420 pp / \$27.50 rrp

Proven Techniques for Troubleshooting the Microprocessor and Home Computer Systems

James Coffron

New!

A collection of debugging techniques for engineers, technicians and hobbyists. The book deals directly with troubleshooting techniques for 8-bit devices, and covers circuits that utilize the 8080, 8085, Z80 and 6800 microprocessor systems. Includes a discussion of how to troubleshoot the TRS-80.

246 pp / \$23.95 rrp

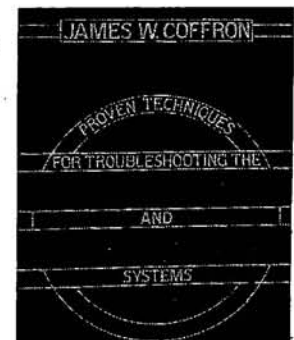

Available from all good bookshops and computer retailers.

In case of difficulty, send your cheque to:

PRENTICE-HALL of AUSTRALIA PO Box 151 Brookvale NSW 2100

NEWCOMERS START HERE

This is our unique quick-reference guide, reprinted every month, to help our readers pick their way through the most important pieces of (necessary) jargon found in APC. While it's in no way totally comprehensive, we trust you'll find it a useful introduction. Happy microcomputing!

Probably the first thing you noticed on picking up this magazine for the first time was the enormous amount of unintelligible-looking jargon. In the words of *The Hitch-Hiker's Guide to the Galaxy*: Don't panic! Baffling as it may sound, the jargon does actually serve a useful purpose. It's a lot easier to say VDU, for example, than 'the screen on which the computer's output is displayed'. This guide is intended to help you find your way around some of the more common 'buzzwords' you're likely to come across in the pages of APC.

For those completely new to computing, let's start with the question: What is a micro-computer? We can think of a micro as: a general-purpose device in contrast to a typewriter, which can only be used for typing; a

calculator, for performing calculations; a filing cabinet, for filing information, to name just a few of its functions. A micro can do all these things and more.

If it's to be of any use, a general-purpose device needs some way of knowing what to do. We do this by giving the computer a set of logical instructions called a *program*. The general term for computer programs is *software*. Every other part of a microcomputer system is known as *hardware*: 'If you can touch it, it's hardware'.

Programs must be written in a form the micro can recognise and act on — this is achieved by writing the instructions in a *code* known as a *computer language*. There are literally hundreds of different languages

around, the most popular of these being *Basic*. Basic is an acronym of *Beginners' All-purpose Symbolic Instruction Code*. Although originally intended as a simple introductory language, Basic is now a powerful and widely used language in its own right.

Other languages you're likely to come across in APC are *Forth*, *Pascal*, *Logo*, *C* and *Comal* to name but a few. These are known as *high level* languages because they approach the sophistication of a human language. You'll also see references in APC to the *low level* languages, *assembly language* and *machine code*. We'll look at these in a moment.

The heart of a micro, the workhorse, is the *processor* or *Central Processing Unit (CPU)*. The processor usually consists of a single silicon chip. As with computer languages, there are a number of different types of processors available, the *Z80*, *6502*, *6800* and *8088* being just a handful (literally!) of the types in common use. The processor is nothing magical — it's just a bunch of electronic circuits. It's definitely not a 'brain'.

As it's electronic, the processor's circuitry can be in one of two states: on or off. We represent these two states by *binary* (base two) notation, the two binary digits (known as '*bits*') being 0 and 1. It's possible to program computers in binary notation, otherwise known as *machine code* (or *machine language*) programming.

Machine code is called a *low level* language because it operates at a level close to that 'understood' by the processor. Languages like

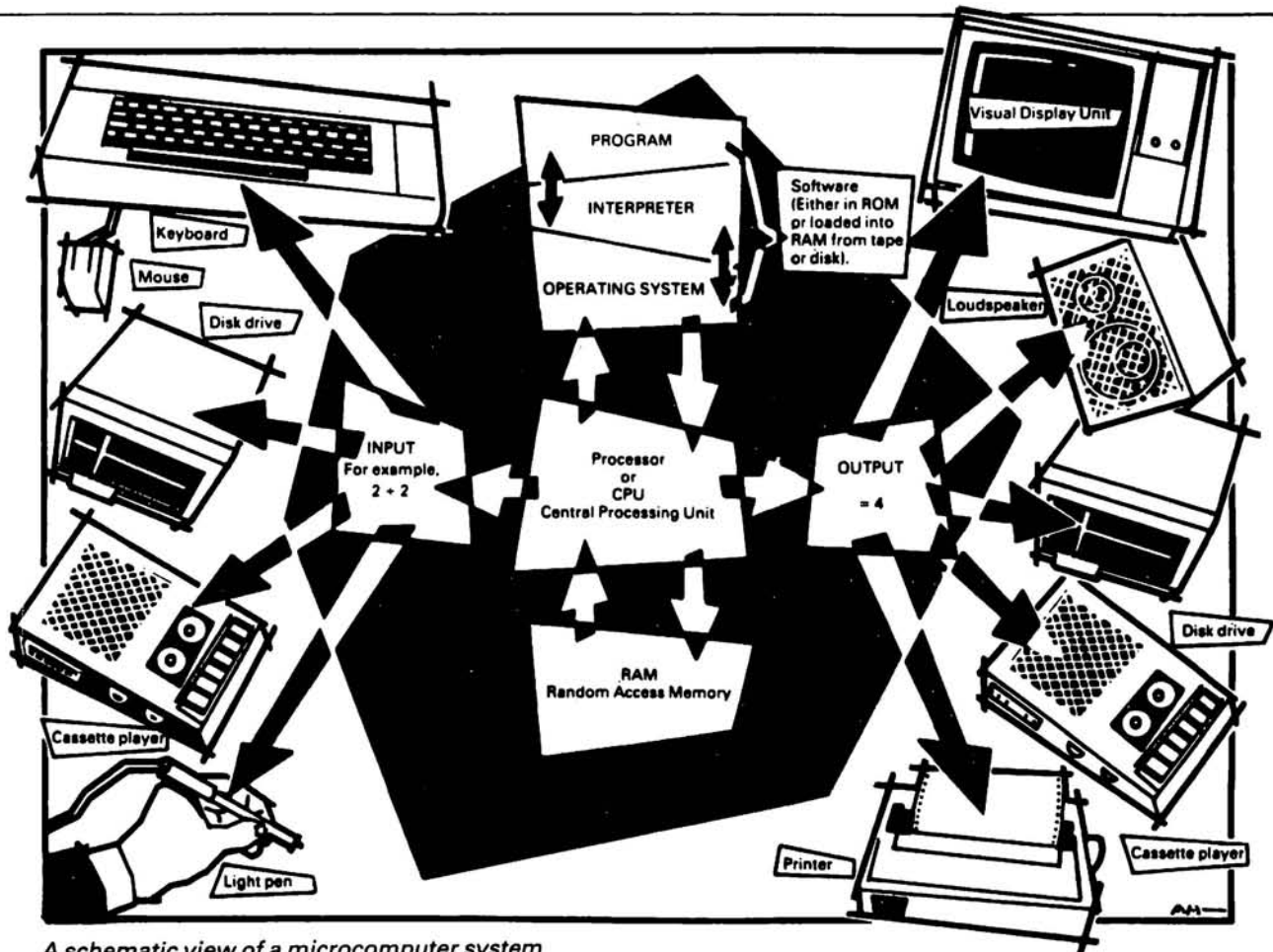

A schematic view of a microcomputer system

Basic are known as high level languages because they are symbolic, operating at a level easily understood by people but not directly understood by the processor.

Between high level languages and machine code is a low level language known as assembly language, or colloquially, *assembler*. This is a mnemonic code using symbols which the processor can quickly convert to machine code.

Since everything has to be converted into binary form before the processor can make sense of it, we need some sort of code to represent each character to be processed by the computer. In order to simplify communication between computers, a number of standard codes have been agreed on. The most widely used of these codes is the American Standard Code for Information Interchange, *ASCII*. This system assigns each character to a decimal number which the processor can then convert to its binary equivalent.

A program written in a high level language must be converted into binary before the processor can carry out its instructions. We could of course do this manually, but since this is exactly the sort of tedious job computers were designed to do for us, it makes much more sense to write a program to do it.

There are two types of program to do this translation for us.

The first of these is a *compiler* which translates our whole program permanently into machine code. When we *compile* a program, the original high level language version is called the *source code* while the compiled copy is called the *object code*. Compiled programs are fast to run but hard to edit. If we want to change a compiled program, we either have to edit it in machine code (extremely difficult) or we have to go back to a copy of the source code. For this reason there is a second translation program: an *interpreter*. An interpreter waits until we actually *run* (use) the program, then translates one line at a time into machine code — leaving the program in its original high level language. This makes it slower to run than a compiled program, but easier to edit.

There are two unusual Basic words you're likely to come across: *POKE* and *PEEK*. When you program in a high level language, you are normally unable to choose in which part of the machine's memory the processor will store things. This makes programming easier as you don't need to worry about memory locations, but slows down the program since the processor has to 'look up' addresses for you. Using the *POKE* command, however, you can 'poke' a value directly into a desired memory address. 'POKE 10000,56', for example, puts the value 56 into memory location 10000. *PEEK* allows you to examine the contents of a particular memory address. If you were to follow the above poke with 'PEEK (10000)', the computer would respond by displaying the value 56. *POKEing* and *PEEKing* is normally done to increase program speed, but may also allow us to do things which could not be done through Basic.

So far, we have a processor and a program. Since a computer needs somewhere to store programs and data, it needs some kind of *memory*. There are two types of memory: *Read Only Memory (ROM)* and the badly-named *Random Access Memory (RAM)*. ROM is so-called because the processor can 'read' (get

things out of) its contents but is unable to 'write to' (put things in) it.

ROM is used to store *firmware*, the name given to software permanently available on the machine. An interpreter is a typical example of firmware (stick with it: it gets easier!).

RAM differs from ROM in two important ways. Firstly, you can write to it as well as read

While we're on the subject of bits, you'll often see computers and their processors described in terms of their *bit power*: 8-bit, 16-bit, 32: 16-bit and so on. This is a means of describing how large a binary number the processor can handle in one chunk. A binary number, incidentally, is known — confusingly — as a *word*. An 8-bit processor, for example, can handle 8-bit words, that is, up to

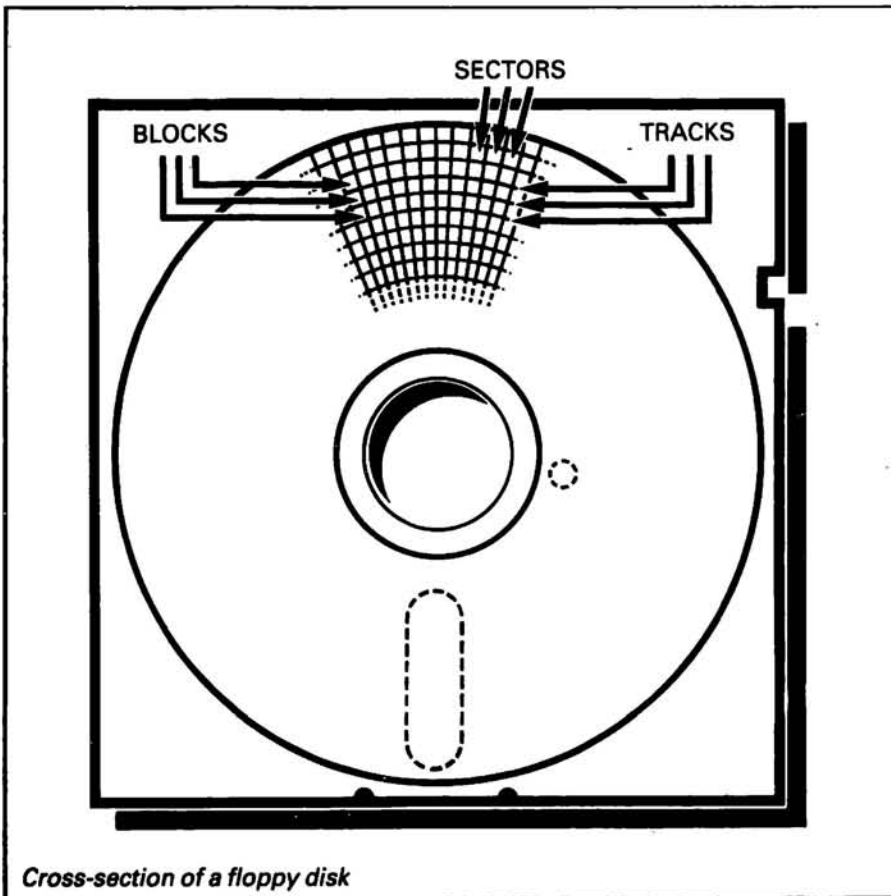

Cross-section of a floppy disk

from it. This means that the processor can use it to store both the program it is running and *data* (information). The second important difference is that RAM needs a constant power supply to retain its contents: as soon as you switch the computer off, you lose your program and data.

There is a type of RAM, known as *CMOS RAM*, which requires only a tiny amount of power to retain its contents. This is found in portable computers like the Tandy 100. It is usually powered by small ni-cad batteries so that programs and data are retained even when the main power is switched off. CMOS RAM is extremely expensive and is not likely to be used in desktop machines for a little while yet. (CMOS stands for Complementary Metal Oxide Semiconductor).

Memory is described in terms of the number of characters we can store in it. Each character is represented by an 8 bit binary number. 8 bits make one *byte* and 1024 bytes make one *Kilobyte* or 1k. 32k, for example, means that the computer can store about 32000 characters in its memory. If 1024 sounds like an odd number, remember that everything is based on the binary system, thus 1,2,4,8,16 ... 1024 being the nearest binary multiple to 1000.

11111111 (255 in decimal). Anything larger than this has to be broken down into manageable chunks before it can be processed.

A 16-bit machine can handle bigger chunks of data at a time. This means it can handle ('address') larger amounts of memory at one time. This is why most 8-bit machines have a maximum of 64k RAM while 16-bit micros usually have 128k upwards.

As 16-bit processors can handle larger words than an 8-bit machine, they ought to be twice as fast. In practice, however, there is a little more to it than that. While it may take a 16-bit machine half as long to work out that $2+2=4$, the actual processing is only part of the story.

The result of the calculation has to be placed into the appropriate memory location, passed to the screen or whatever is required. The transfers to and from the processor are often made in 8-bit form; this is why you'll hear people arguing that certain processors are not 'true' 16-bit. If the problem has to be handed to the processor in 8-bit form, turned into 16-bit, calculated and then the result turned back into 8-bit for transfer elsewhere, there may be little or no saving in time over an 8-bit system.

The other factor affecting speed is that the

actual processing may form only a small part of the overall operation. A word processor, for example, spends most of its time passing files to and from disk and waiting for the user to type the next character. The processing itself consumes very little time. And if you look at the Benchmarks summary (APC, February 1984, pp 59-60), you'll see some 8-bit machines beating their 16-bit rivals — even in processor-bound operations like the APC Benchmarks.

Returning to the subject of RAM for a moment, a word of warning: Don't rush out with your new-found understanding to buy the machine offering you the most RAM for your money. Quite aside from the fact that the amount of RAM is by no means the only consideration when buying a micro (no matter how much manufacturers may stress it), different machines use differing amounts of RAM for things like graphics. Always check how much RAM is actually available to the user for program storage. Machines which proudly proclaim '64k' may well leave you with less than half of this in which to store Basic programs and data.

There are numerous forms of *permanent* or *back up storage*, but by far the most common are *floppy disk*, *floppy tape* and *cassette*.

Floppy disks or diskettes are circular pieces of thin plastic coated with a magnetic recording surface similar to that of tapes. The disk, which is enclosed in a protective card cover, is placed in a *disk drive*. Disk drives comprise a high-speed motor to rotate the disk and *read/write head* to record and 'play back' programs and data.

The disk is divided into concentric rings called *tracks* (similar to the tracks on an LP) which are in turn divided into small *blocks* by spoke-like divisions called *sectors*.

There are two methods for dividing the disk into sectors. One method is called *hard sectoring*, where holes punched in the disk mark the sectors, and the other is *soft sectoring* where the sectors are marked magnetically. The reason that disks from one machine can't be read by a different make is that each manufacturer has its own way of dividing up the disk. Recently, however, manufacturers have apparently begun to acknowledge that this situation can't go on forever, and they are working on making their disks compatible.

Since the computer needs some way of organising the disk, we have a program called a *Disk Operating System (DOS)*, usually known simply as the *Operating System (OS)*. The operating system does all the 'housekeeping' of the disks, working out where to put things, letting the user know what is on the disk, copying from one disk to another and so on. As you might expect by now, there are lots of different operating systems available, each with its own advantages and disadvantages. The three most popular OSs are *CP/M* (Control Program for Micros), *MS-DOS* (Microsoft Disk Operating System) and *PC-DOS* (Personal Computer Disk Operating System). MS-DOS and PC-DOS, incidentally, are all but identical.

Disks can support what are known as *random access files*. That is, you can randomly choose a point in a file and the drive head will move directly to that point. You can then edit the file, and only the blocks affected will be rewritten, the rest of the file remains unchanged.

Floppy disks provide a reasonably fast and

efficient form of secondary storage and are cost-effective for business machines. For home computers, however, the usual form of program and data storage is on ordinary cassette tape using a standard cassette recorder. This method of storage is slow and unreliable, but is very cheap and adequate for games, for example.

Cassettes can support only *serial access files*. That is, whenever a file is to be edited, the whole file must be written back to the tape. This makes certain applications — word processing being a prime example — extremely tedious.

Floppy tape drives are a compromise between speed and cost. They use a small continuous loop tape which, like a disk, is divided into blocks. Floppy tape drives rely on serial access files, but by rotating the tape at high speed and using the block markers, they can simulate random access files.

Another type of disk you'll see referred to is the *hard disk*. This is an extremely efficient method of storing large amounts of data. Hard disk capacity generally starts at around 10Mbytes (10 million bytes) and rises to . . . well, you name it. Besides offering a much greater capacity than floppies, hard disks are more reliable and considerably faster. They are, however, much more expensive than floppy drives.

Since computers need some way of communicating with the outside world, we need *input* and *output* devices. Input and output devices include all manner of things from hard

with each other in this way, standards have been agreed for different *interfaces*. An interface is simply a piece of circuitry used to connect two or more devices. The most common standard serial interface is the *RS232* (or *V24*) while the Centronics standard is popular for parallel interfaces.

When two computers want to communicate with each other over a distance, there are again two ways of doing it (nothing is ever clear-cut in the world of micros — you'll get used to it). Both methods use the public phone network. The first is known as an *acoustic coupler*. This simply plugs into your computer, and has a receptacle into which you place your telephone handset. The acoustic coupler is convenient in that you can unplug it from one computer and plug it into another one in a matter of seconds. They are generally slow, however, and prone to interference.

The alternative method is to use a *modem*. Unlike an acoustic coupler, a modem is wired into the telephone system and you should get permission for this from Telecom.

A term you'll hear used in connection with acoustic couplers and modems is *baud rate*. The baud rate is a measure of the speed at which a device can transmit and receive data. You can safely think of the baud rate as being bits-per-second, though the accurate definition is a little more complex. Therefore, a 300-baud modem can transmit/receive data at the rate of 300 bits (about 50 characters) per second.

A 1200/75 modem means that it receives

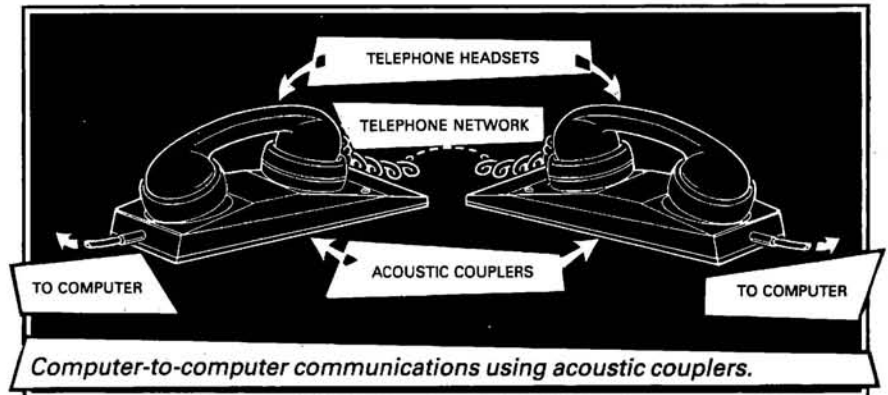

disk units to light pens, but the minimum requirement for most applications is a typewriter-style *keyboard* for input and a TV-like *Visual Display Unit* for output. The Visual Display Unit is variously referred to as a *VDU*, *Cathode Ray Tube (CRT)* and *monitor*.

The various component parts of a computer system (processor, keyboard, VDU, disk drives, and so on), may be separate, connected by cables.

Take this paragraph slowly and it will make sense! When a computer communicates with an outside device, be it a printer or another computer, it does so in one of two forms — *parallel* or *serial*. *Parallel input/output (I/O)* requires a number of parallel wires. Each wire carries one bit, so with eight wires we can transmit/receive information one byte at a time (8 bits = one byte, remember). *Serial I/O*, in contrast, uses a single wire to transmit a series of bits one at a time (that's why it's called *serial*), with extra bits to mark the beginning and end of each byte.

To enable different devices to communicate

at 1200 baud but transmits at 75. Most modems are 1200/75 and acoustic couplers 300/300. By way of comparison, saving programs to cassette is normally done at between 300 and 1500 baud.

Finally, communications between computers is either *full* or *half duplex*. Full duplex is when the machine receiving the data echoes it back to the machine transmitting it and says 'This is what I think you said — is that right?'. If it's wrong, the section will be transmitted again. Half duplex is where no checking is made. If you're ever unsure of which to use, start with full duplex. If everything you type appears on your display twice, then you should switch to half duplex.

Now that you know the jargon, you'll excuse me while I go and initiate a file transfer from secondary memory to RAM in order to engage some real time interactive processing with 32k 8-bit micro, using a direct entry input device and cathode-based visual feedback system. I never could resist a game of Pacman.

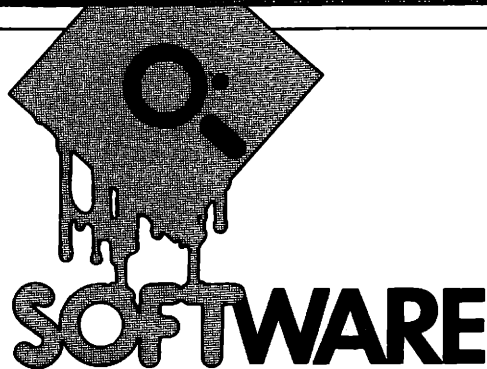

VISIWORD

Most micros installed are used for some degree of word processing, and the selection of a word processing package is crucial to the machine's usefulness. Ian Davies takes a look at Visiword, by Visicorp.

"Word processing" packages fall into two distinct categories. The first type is called a "text formatter" (although often labelled a word processor in advertisements), and can be found on most mainframes hiding behind names such as runoff, roff and script. They are characterised by the fact that your text is prepared using a relatively dumb editor, usually the system editor, and that commands to the formatter are placed within the text on separate lines beginning with some special marker. Once the text has been prepared, the text formatter reads in your input file and creates a neatly formatted output file ready to send to a printer. While text formatters do have their uses, they are certainly not productivity tools, and most typists and non-programmer types are generally horrified at the idea of using them. Be warned: some "word processors" available on micros today are, in fact, text formatters.

The second type of word processor is the "true" word processor also known as the "what you see is what you get" variety. These come in several grades, usually limited by the hardware (although some do not approach the hardware limitations), ranging all the way up to the "top shelf" Lisa-write, with on-screen proportional spacing and fonts.

Visiword is of the "what you see is what you get" variety — providing as much functionality as the hardware can reasonably provide. It supports on-screen real-time justification so that your hard copy is never too different from what you have been seeing on the screen. We reviewed Visiword running on an IBM XT.

Visiword is capable of running on quite a modestly configured machine including at least 192k RAM, a single disk drive, monochrome or colour monitor and a printer. Support for a hard disk is also provided. The software is packaged on a single diskette and a function key template is included. Installation of

Visiword is really no problem so long as you follow the instructions precisely.

First look

Visiword is designed to use hierarchical menus rather than control keys. This means that Visiword is very easy to just pick and use, but would slow down an experienced Visiword typist.

The menus occupy the bottom two lines of the screen, and are accessed by pressing the ESC key. The bottom menu line shows a series of keywords which may be highlighted by use of the cursor control keys. The top line shows a brief description of the highlighted function. Functions may be selected either by moving the cursor to the desired selection and then pressing the ENTER key, or by simply pressing the first character of the desired selection. This provides the hesitant first-time user with the ability to proceed cautiously, as he can always see a description of what is about to happen before it actually does. The confident user can simply call functions by pressing the first letter of the menu selection, and thinks in terms of "Layout Character Underline" rather than visually navigating through three levels of menu. This is the same mechanism employed in the highly successful Lotus 1-2-3 spreadsheet system, and generally meets with much end-user approval.

All Visiword menus include "quit" and "help" functions. The help is context dependant and, while being of some assistance, is no substitute for the manual. Help is only available when a menu is displayed, in other modes of operation, such as altering a ruler, no help can be requested.

Visiword makes use of 9 of the 10 PC function keys, providing single stroke access to decimal tab, again, new page, indent, delete line, delete to end of line, underline, centre line and un-delete. The undelete facility is only available when

the deletion was caused by one of the deletion function keys. Other PC keys are used to provide cursor control, page up, page down, tab, character insert and delete, destructive backspace and non-destructive backspace.

Special graphics characters are used to mark special effects such as page-breaks and centred and indented text.

Functionality

Visiword maintains your entire document in memory, hence the maximum size of any single document is directly proportional to your installed memory. On a 192k machine, Visiword can handle a document of 35 to 45 pages under DOS 1.1, or 20 to 30 pages under DOS 2.0. Longer documents can be created by buying more memory, or by using the Append facility to link separate document files together.

Visiword provides 20 lines of 78 columns for text entry and can support a maximum line length of 255 characters, accessed through screen-at-a-time horizontal scrolling. It is also capable of directly editing standard DOS ASCII files without the need for conversion utilities. Files created by Visiword are not simple ASCII files due to the formatting information stored within them, but can be converted to such using the "Print Disk" facility.

Powerful options are provided to control document layout. These are accessed via the layout command, as shown in figure 1. The format option provides control over line spacing, justification (on/off), page length, characters per inch and set-up strings to be sent to your printer. The document format may be altered at the end of any paragraph, with the appropriate symbol appearing on the screen to indicate that a new format is in effect. Other layout options are provided to control the ruler (maximum line length, tab stops, etc), headers, footers

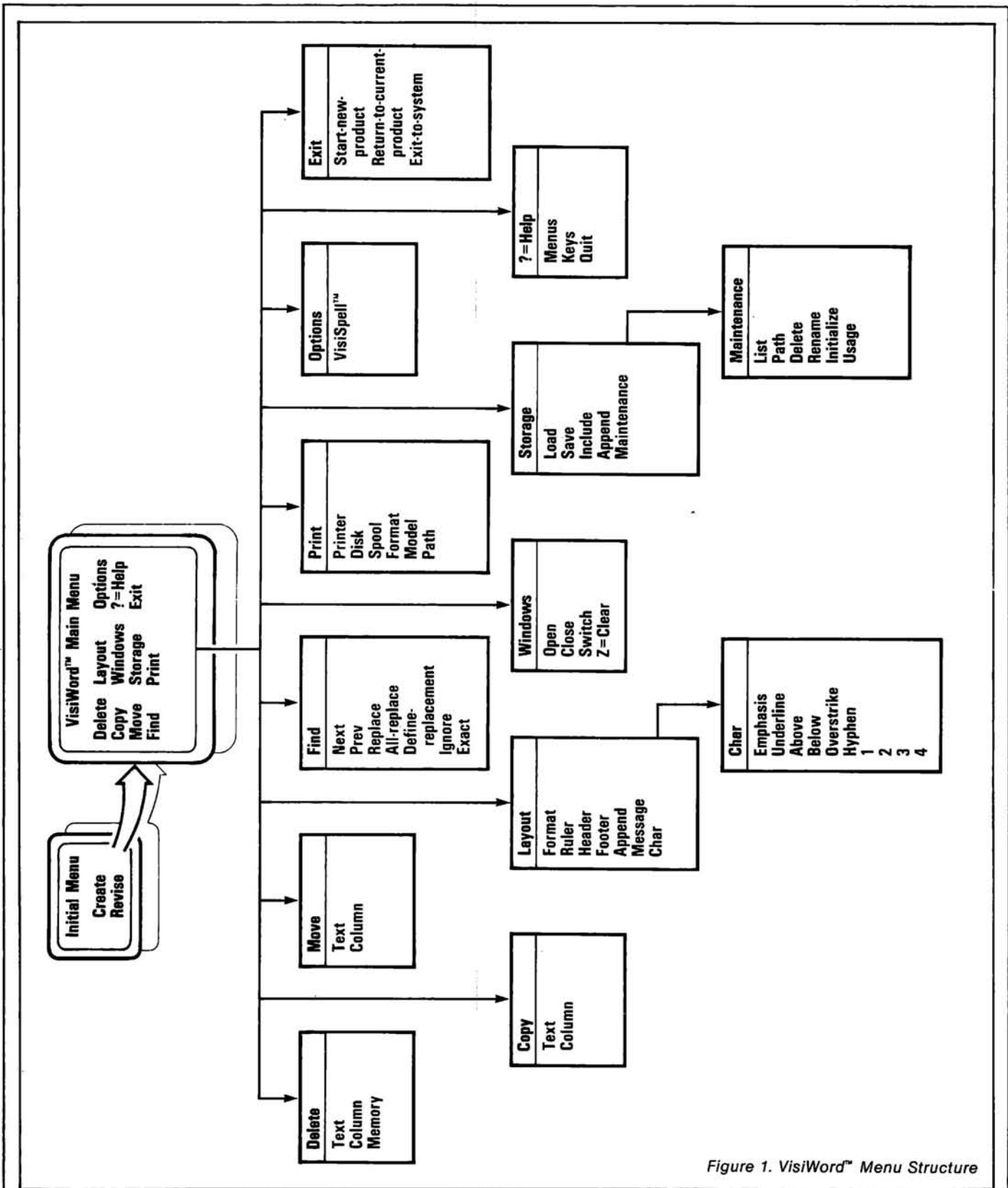

Figure 1. VisiWord™ Menu Structure

and character attributes including superscripts, subscripts and overstrike. Layout options also control the linking together of separate document files and any messages you may want to produce while the document is printing.

The Find command provides the facility to both find and/or replace, on

either a global or selective basis. Options are available to make case either significant or insignificant. Since Visiword keeps the entire document in memory, the find/replace commands operate rather quickly. To perform a global replace on a series of linked documents, it is not necessary to edit them one at

a time.

Two windows may be opened using the Windows command. This facility allows you to either view two different parts of one document, or two completely separate documents at the same time. Text can be moved or copied between the two windows even if they

are separate documents. Changing from one window to the other is achieved using the "[ESC] Windows Switch" command.

Moving, copying and deleting can be done on either a text or column basis, where a column is simply a series of vertically aligned characters on two or more lines. It is interesting that Visiword provides the ability to move and copy columns, but does not provide any easy way of creating them, or of adding numeric columns.

File utilities are provided to load, save, include, list, rename, delete and format. These utilities can be used on all files, not just files created by Visiword. Copying a file is achieved by loading it and then saving under a different name.

Printing may be done directly to the printer, directly to disk, or spooled to the printer. Spooling is only possible on hard disk or dual drive systems, and only one document can be spooled at a time. Format options allow you to select the starting point, number of pages, margin, paper length, top margin and whether or not to pause at the end of each page. A series of printer set-up strings may also be declared. Visiword supports the following printers: Epson, IBM, NEC Spinwriter, Qume, Diablo and Okidata. Menu options can be used to select between the two parallel ports and two serial ports, depending on how your printer is connected.

Omissions

No word processor can (or should) have every facility imaginable. The trick is to make sure the package you select has all the facilities you require. For this reason, I will list some of the features not found in Visiword that some users may consider essential.

Visiword does not provide the ability to produce form letters, also known as mail-merging. This facility is provided by a separate package called Visifile — Similarly, Visiword cannot sort, provides no integrated communications facility, and cannot store sequences of key strokes. Visiword is not capable of arithmetic, although this facility can be simulated by purchasing the Visicalc package.

For users creating large monolithic documents, Visiword does not provide automatic page number generation, cannot go directly to a particular page without scrolling through all the pages in between, and cannot produce indices.

As far as formatting facilities are concerned, Visiword cannot set decimal tabs in rulers, cannot set markers in text and cannot identify "orphan sentences".

Spooling is limited to a single document, and no spool control facilities are

provided other than the ability to cancel the spooling document. There is no facility to move the cursor on a word, sentence or paragraph basis.

It sounds as though there are many features Visiword does not support, and this is true, but you will find no single word processor that supports every possible facility and it is simply a matter of selecting those features you feel to be most useful to you.

Visispell

Visispell is the spellchecker for Visiword, and is probably one of the most user-friendly and intelligent spell checkers available.

Supporting a 100,000 word in-memory dictionary, plus a personal dictionary, Visispell not only checks your spelling, but also detects irregular capitalisation and repeated words. It can check/edit Visiword documents directly, and can also handle normal ASCII files.

Some of the nice Visispell features are the ability to simply alter an incorrect word manually, mark an incorrect word, add a new word to your personal dictionary as it is encountered and also manually maintain your personal dictionary. My favourite feature was that it did not have to be told twice. Once you had told it that "CPU" really was a word, it would not complain about any other occurrences of "CPU". Similarly consistent mis-spellings are automatically corrected. Additionally, Visispell is fast — mainly because its dictionary is kept in memory. Although slight delays occur when it is searching for an alternative spelling.

The only drawbacks are that alterna-

tive spellings are presented one at a time, and that Visispell keeps on showing you its discoveries and asking what it should do — it does not appear possible for Visispell to simply scan through a large document marking all queries while you are out at lunch.

Documentation

Visiword is well documented in an attractive black binder. Included is a quick reference card, quick start guide, installation guide reference manual, good index and instructions on how to interface with other Visi products.

While the documentation goes into great depth on the elementaries of moving, copying and deleting, it does tend to gloss over the less apparent features such as "delete memory".

Conclusion

It has become clear that Visiword was not designed for use by professional word processor operators — it is too slow to use menus and is simply not powerful enough. Similarly, it has not been designed for producing 200 page proposals. Visicorp has targetted its market quite carefully and has designed Visiword to provide features which will be appreciated by that market, such as easy to use menus and keeping the document in memory.

Visiword is an excellent product for users with occasional word processing requirements of small to medium volume. Visiword and Visispell are sold together in one package as Visiword Plus at a recommended retail price of \$633 including sales tax.

EMERALD HILL COMPUTER BROKERS

Meta 4

The Australian Data Base Adventure Out-performs on Features

Ease of use

Flexibility

Price

We are confident that once you see the 145 page manual you will buy the system. Send **\$20.00** for the manual. When you are convinced that Meta 4 is better than its competitors, the \$20.00 is deductible from the system price of **\$200.00**

Order now on **(03) 690 8095**

294 Kingsway, Sth Melbourne, Vic 3205

MONITORS
NEW SWIVEL BASED MONITORS
HIGH RESOLUTION GREEN SCREEN
20 MHz BANDWIDTH
\$229

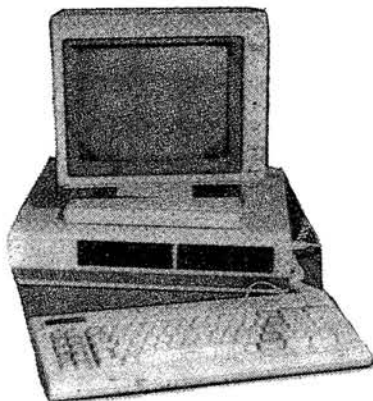

These fine monitors add the finishing touch to your system. Complete with a professional swivel base and flush mounted controls.

CASE AND KEYBOARD

Give your computer a decent home. Room for two 5 1/4" Drives and power supply. (Drives shown not included).
\$295.00

OUR FAMOUS RITRON MONITORS
IN AMBER AND GREEN.
18 MHz BANDWIDTH
AMBER **\$229** GREEN **\$199**

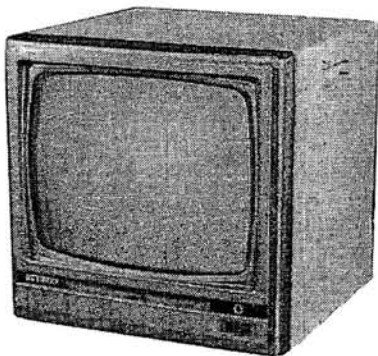

- High quality, non-glare CRT.
- Compact and lightweight with all Controls Inside Front Panel.
- All units 100% Factory Burned-In.
- 800 lines centre resolution.
- Suitable for Apple* — and other computers. (Apple is a registered trademark of Apple Computer, Inc)
- Green or Orange Phosphor available.
- 18MHZ.

COLOUR MONITORS
GENERAL TELEVISION SETS
WITH DIRECT VIDEO INPUT

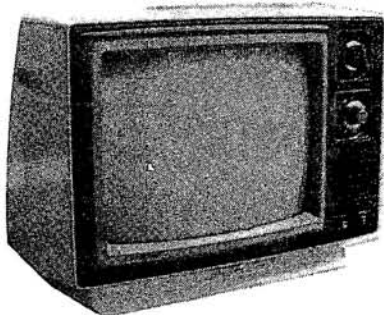

These line General Sets have been converted for use as colour monitors
14" Rotary Tuner..... **\$389**
16" Rotary Tuner..... **\$469**
18" Rotary Tuner..... **\$499**
20" Rotary Tuner..... **\$549**
26" Remote Control..... **\$849**
All monitors supplied with circuit modifications in case of service after one year warranty period has expired.



ROD IRVING ELECTRONICS

425 High St., Northcote Vic. 48-50 A'Beckett St., Melb., Vic.
Phone (03) 489 8886, (03) 489 8131
Mail Order Hotline (03) 481 1438
Mail orders to P.O. Box 235 Northcote 3070 Vic.
Minimum P & P \$3.00. Errors & omissions excepted.

Please address tax exempt, school, wholesale and dealer enquiries to:

RITRONICS WHOLESALE

1st Floor 425 High St., Northcote 3070. (03) 489 7099
(03) 481 1923 Telex AA 38697

CONSUMABLES

VERBATIM DISKS

C12501	MD525-01	Single sided, Double density	38.00
C12502	M5525-10	SSDD 10 Sectors 40 Tracks	46.50
C12503	MD525-16	SSDD 16 Sectors 40 Tracks	46.50
C12504	MD550-01	Double sided, Double density	55.00
C12505	MD550-10	DSDD 10 Sectors 40 Tracks	55.00
C12506	MD550-16	DSDD 16 Sectors 40 Tracks	55.00
C12507	MD577-01	SSDD Soft sector 80Tracks	55.00
C12508	MD577-10	SSDD 10 Sectors 80 Tracks	61.50
C12509	MD577-16	SSDD 16 Sectors 80 Tracks	61.50
C12510	MD577-01	DSDD Soft Sector 80 Tracks	68.00
C12511	MD577-16	DSDD 16 Sectors 80 Tracks	68.00

8" VERBATIM

C12800	FD32-1000	Single sided, Single density	46.00
C12801	FD32-8000	Single sided, Double density	58.00
C12802	FD32-9000	SSDD Critically Certified	57.00
C12803	FD34-1000	Single sided, Single density	46.40
C12804	FD34-8000	Single sided, Double density	55.00
C12805	FD10-4008	Double sided, Single density	64.00
C12806	FD10-4015	Double sided, Single density	64.00
C12807	FD10-4026	Double sided, Single density	64.00
C12808	FF32-2000	SD FLIPPY FLOPPY	67.00
C12809	FF34-2000	SD FLIPPY FLOPPY	67.00
C12810	DD32-4000	Double sided, Double density	57.00
C12811	DD34-4001	Double sided, Double density	57.00
C12812	DD34-4008	Double sided, Double density	57.00
C12813	DD34-4015	Double sided, Double density	59.40
C12814	DD34-4026	Double sided, Double density	59.40

All prices for boxes of 10. Single disks 10% extra.

CONTROL DATA DISKS

5" Control Data

C13500	1242	Single sided, Double density	30.00
C13501	1244	Double sided, Double density	44.16

8" Control Data

C13801	1221	Single sided, Single density	34.80
C13802	1223	Single sided, Double density	46.80
C13803	1225	Double sided, Double density	57.60

Head Cleaners

C12551	5"	Head Cleaner	12.60
C12851	8"	Head Cleaner	11.40

PAPER

COMPUTER PAPER

C21001	9"	Keen edge tractor feed paper in box of 2000 sheets	\$34.80
C21011	15"	Keen edge tractor feed paper in box of 2000 sheets	\$46.80

RIBBONS

C22001	QUME Daisywheel Printer		
	Multistrike Film		\$6.48
C22003	QUME 4, 7, 9 Daisywheel Printer		
	Multistrike Film		\$12.84
C22022	DIABLO HYTYPE II Daisywheel Printer		
	Nylon, Black		\$8.88
C22041	TANDY TRS80 269-1414 Matrix Printer		\$16.08
C22051	ITOH 8510, 8600, NEC 8000		
	Matrix Printer		\$13.51
C22002	QUME Daisywheel Printer Nylon, Black		\$8.64
C22021	DIABLO HYTYPE II Daisywheel Printer		
	Multistrike Film		\$8.88
C22031	EPSON M80 Matrix Printer Nylon, Black		\$13.51
C22042	TANDY TRS80 Line Printer VI		
	Matrix Printer		\$15.60
C22061	BURROUGHS 9246-3, 9246-6		
	Belt Printer		\$27.60

PRINTERS
JUKI PRINTER WITH 8K BUFFER
DAISY WHEEL 18CPS
\$1045.00

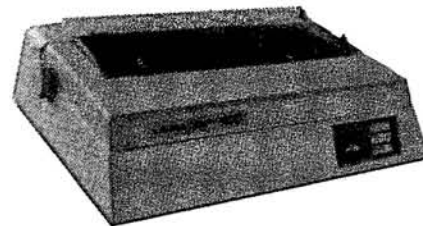

A high quality daisy wheel printer with a large buffer so it won't tie up your computer. The JUKI uses the wide range of Adler wheels and readily available IBM electric ribbons. (Selectric is a Registered trade mark of IBM.)

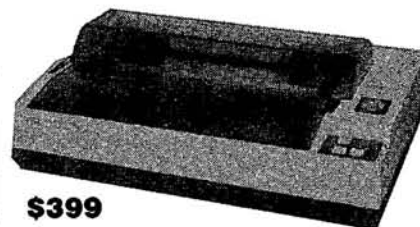

\$399

This is the popular 80 column printer we have been selling for six months. Don't be fooled by the one with a cheap mechanism. Ours is a high quality print head and mechanism.

- Low price
- Compact, and Lightweight Designed.
- 640 Graphic Dots Line.
- 80 Column Dot Matrix Printer with a full of Functions.
- Cartridge Ribbon.
- Connectable to the many types of Computers for the Home or Office.

DISK DRIVES

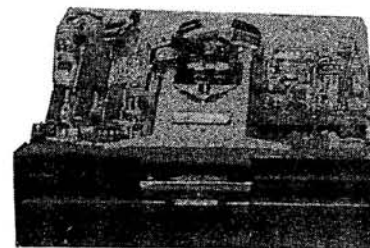

THE MITSUBISHI RANGE OF DISK DRIVES

M2896-63
Slimline 8" Disk Drive Double Sided Double Density No AC Power required. 3ms Track to track. 1.6 Mbytes unformatted, 77 track side 10" bit soft error rate.
..... **\$575.00**
Box & Power Supply to suit..... **\$128.00**

M2894
Standard size 8" drive. Double sides, double density. 3ms track to track access. 1.6 Mbytes unformatted, 77 track/side. 10" bit soft error rate **\$575.00**
Box & Power Supply to suit..... **\$125.00**

M4854
Slimline 5 1/4" disk drive. Double sides, double density. 96 track/inch. 9621 bit/inch. 1.6 Mbytes unformatted. 3ms track to track access, 77 track/side..... **\$378.00**
Box & Power supply to suit **\$79.00**

M4853
Slimline 5 1/4" disk drive. Double sides, double density. 1Mbyte unformatted. 3ms track to track, 80 track/side. 5922 bits/inch. Steel band drive system..... **\$355.00**
Box & Power Supply..... **\$79.00**

MP 5" STANDARD DRIVES

Drive	Only	Case & Power Supply Inc
B51	\$269.00	\$299.00
B52	\$349.00	\$379.00
B91	\$349.00	\$379.00
B92	\$439.00	\$459.00

P - R - O - F - I - L - E

"I'm The Most Efficient Software Producer In The World"

Steve Withers caught up with Microsoft's founder, Bill Gates, at the 2nd Australian Personal Computer Show.

Bill Gates is one of the most intense individuals in the microcomputer industry. He is totally involved in his company, and often speaks as if Microsoft is an extension of his own personality — he refers to "my manuals" and "my software". If this came from most corporate heads it would appear arrogant, but Gates does run the development side of the company on a day-to-day basis.

He seems almost hyperactive: in the middle of a sentence he is likely to stand up and start pacing around the room. While Gates still works the long hours of a "hacker", he says he doesn't work all night as often as he did. When asked, he admits that he doesn't have many interests outside Microsoft (even his close friends are drawn from the company), but he points out that with such wide-ranging work there is always something different waiting to be done. For example, he works on software development and looks after his team, he travels widely, deals with major customers, and often writes for magazines (somehow he finds the time to read 19 a month!) — whenever he gets bored with a particular aspect of his work there is bound to be something fresh to which he can turn.

It was interesting to hear Gates claim that right from its creation in 1975 Microsoft was intended to become large, dominant, and technically advanced. He says the two main reasons for concentrating on software were that they (Gates and his partner, Paul Allen) decided that hardware manufacturing would be too risky, and that software was expected to become more important in the long run.

He believes Microsoft's current position is the result of its ability to get a product out through the door. By concentrating on methodology, they are able to ship a product within six months of its inception. Unlike other software companies, Microsoft has one-third of its programmers working on tools to increase the productivity of their fellow developers. Gates points out that this is a long-term investment, as these tools

must be used in the development of three or four packages before the costs are recouped. "Three or four" programs doesn't sound like much, but how many packages have companies like Ashton-Tate or Lotus Development Corporation produced?

Not only is Microsoft prepared to devote part of its resources to the task of improving productivity, but it is also sufficiently profitable to support a "blue sky group" charged with investigating ideas and techniques that may one day find a place within the company or its products.

Gates believes Microsoft is in a very secure position for a variety of reasons. First of all, he concentrates his efforts on what he knows best: software. The company has ventured into hardware in a small way (small is relative, of course, as the Apple II fitted with the Microsoft Softcard is the biggest-selling CP/M-based system) as well as offering training aids, but these are seen as being fringe activities. Secondly, capital invest-

ment and running costs are low — sales of Microsoft Word produce enough revenue to cover the company's expenses. This means the company is almost awash with cash and has no loans to repay. Thirdly, the market tolerates, even welcomes diversity in programming languages and applications, but when it comes to operating systems there is bound to be a clear-cut leader.

Some industry observers (including Rodney Zaks) have suggested that IBM's next move is likely to be the development of PC hardware and software that is more compatible with their larger systems, turning away from the rest of the micro industry. Gates discounts this idea, pointing out that as IBM achieved such success by working with Intel and Microsoft, why would it risk upsetting current users by such an extreme change of direction? In any case, he says, Microsoft would be out selling compatible software to other manufacturers (Microsoft has a very close relationship with a large range of hardware com-

EMERALD HILL COMPUTER BROKERS

Introducing GEM P.C.

The Affordable Alternative

FEATURES:

- ★ 8088 processor
- ★ Detachable keyboard
- ★ Runs IBM software
- ★ 128K RAM
- ★ Dual disk drives, 320K each.

Costs Only **\$3200.00** inc tax

or **\$2800.00** ex tax

Including High-Res Monitor

Ring now for next day delivery. Phone: (03) 690 8095
294 Kingsway, Sth Melbourne, Vic 3205

AUTOCAD

COMPUTER AIDED DESIGN

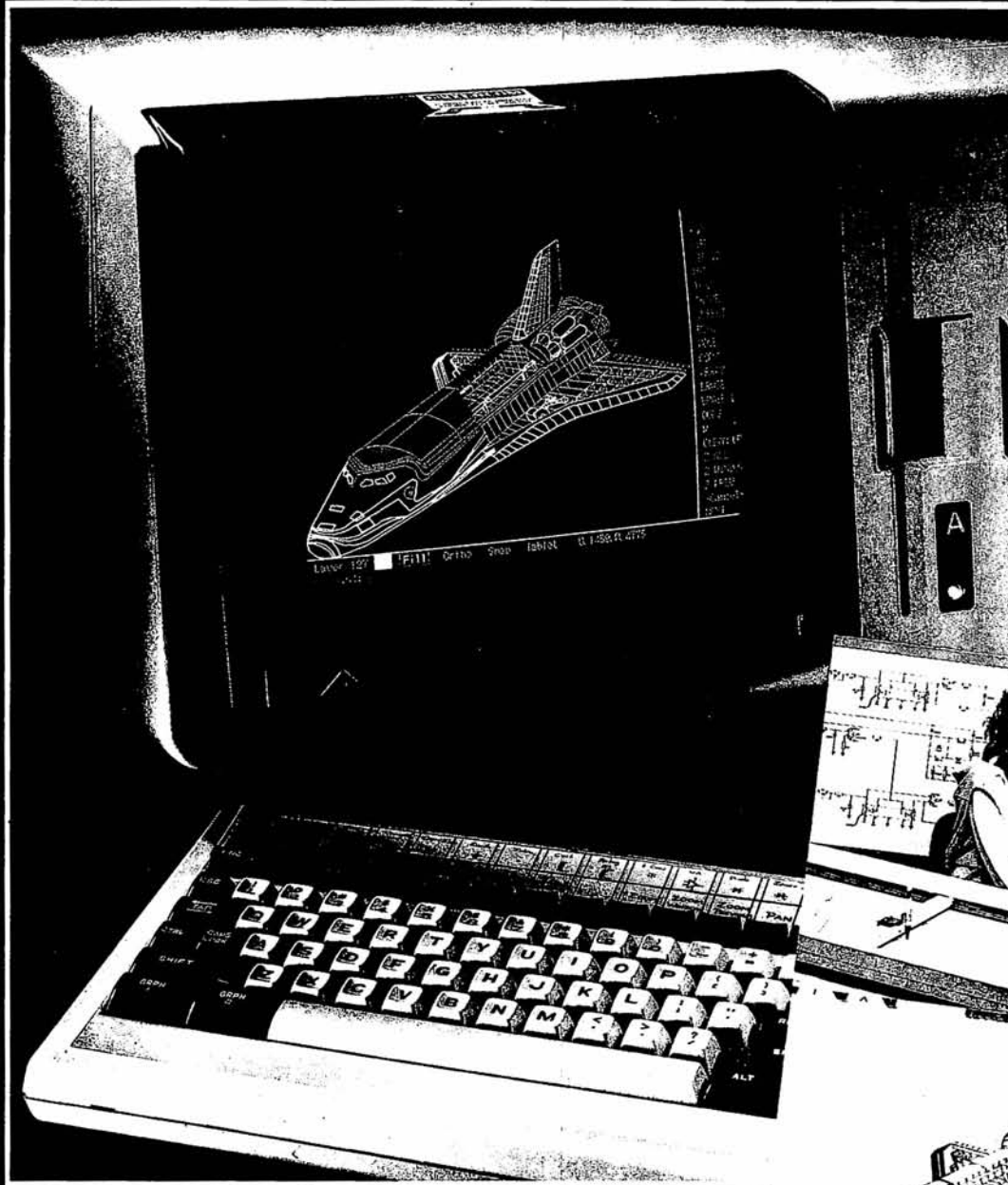

**First Micro
with Full
Colour
CAD**

On The NEC Advanced Personal Computer

AutoCAD is a general purpose system, suitable for a wide variety of applications, including architectural and landscape drawings, drafting for mechanical, electrical, electronic, chemical, structural and civil engineering, and printed-circuit design. A sketch facility allowing free-hand drawings via a digitizer makes the system most suitable for graphic artists as well.

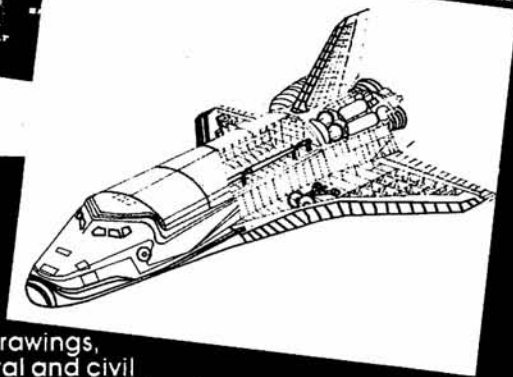

NEC

NEC Information Systems Australia Pty. Ltd.
99 Nicholson Street, St. Leonards, NSW 2065. Tel: (02) 438 3544
11 Queens Road, Melbourne, VIC. 3004. Tel: (03) 267 5599
307 Queen Street, Brisbane, QLD. 4000. Tel: (07) 229 6777

ENTERCOM COMPUTER LTD

ENTERCOM COMPUTER CO. is the authorised distributor of AUTOCAD.
136 Bridge Road, Richmond, VIC. 3121. Tel: (03) 428 5714, (03) 429 5883

Official AutoCAD software for the NEC APC must be registered through ENTERCOM COMPUTER CO. to protect the copyright conditions of the originating supplier being AUTODESK.

*AUTOCAD is a registered trademark of AUTODESK INC.



this process to result in a significant change in Microsoft's ownership, mainly because he has no intention of selling his own shares.

When asked about Microsoft's relationship with Digital Research, Gates seems to be trying hard to give the impression that DRI has had its day and is spending all its time keeping up with him. In the past, he says, Microsoft often referred potential customers (including IBM) to Digital Research, but that doesn't happen any more. I couldn't help feeling sceptical when Gates claimed that DRI is simply following Microsoft's lead — after all, Concurrent CP/M has already appeared, while a multi-tasking version of MS-DOS is still just a promise.

The current debate about copyrights and piracy (or theft, if you prefer) seems to puzzle Gates. He believes that it is really a simple matter: programs should be protected in exactly the same way as the manuals that describe them — a simple, workable arrangement without the complications of explicit licence agreements. Microsoft does not hesitate to use the law against commercial pirates, and Gates claims complete success in shutting down such organisations in the USA. In his opinion the long term answer is to ensure that schools expose their pupils to a set of ethics that are appropriate to an age in which intangibles like information and programs are just as important as material goods.

Bill Gates has achieved a remarkable level of success with Microsoft, and he still enjoys his life and work. He's got the software world by the tail, and the self-confidence to hang on.

panies), as well as providing IBM's customers with applications software.

Microsoft's future product range should be much broader than it is at present. Apart from so-called "vertical applications" (programs designed for use within a certain profession or occupation, such as farming), Gates sees the whole of the software market as fair game for Microsoft. Within the operating systems arena, he believes Xenix will become increasingly important, even though it already has 70% of the market for Unix licences. One problem he has identified is that of differentiating Xenix from Unix. Xenix is a Unix derivative, but a program written for Xenix will not necessarily run under Unix. One important difference is that Xenix provides record-locking facilities (needed if several users will be updating a single file at one time), but Unix doesn't. Gates is trying to encourage software developers to write for Xenix rather than Unix — if he succeeds, Microsoft will have a significant marketing edge if and when the market for Unix-like systems takes off.

Gates intends to turn Microsoft into a public corporation sometime in the next few years. "I don't like the idea of going public" he said, explaining that he would

much rather talk about a new user interface than to a financial analyst, but many Microsoft employees own shares in the company and he feels they deserve the chance to realise part of their stake in the company if they wish. He doesn't expect

EMERALD HILL COMPUTER BROKERS



Buy an **ARCHIVES P.C.**

with teach yourself
Word processing Tutorials
for only

\$2394.00 inc tax
or **\$25.00** per week

Get \$2000.00 worth of Software for FREE

Ring now for next day delivery. Phone: **(03) 690 8095**
294 Kingsway, Sth Melbourne, Vic 3205



MicroProfessor

MPF-III

THE LATEST TECHNOLOGY IN 64K MICRO COMPUTERS DUAL PROCESSORS — 6502 and Z80 RUN APPLE IIe and CP/M SOFTWARE

● SMALL BUSINESS ● EDUCATION ● HOME ● HOBBY

STANDARD FEATURES

- Runs 8 languages
- Upper and lower case
- Detachable keyboard with 90 keys
- 40/80 column (keyboard selectable)
- Centronics printer interface
- 38 tone sound generation chip
- Powerful editing features
- 4 additional expansion slots
- One key basic command entry
- 12 programmable function keys
- Numeric keypad
- R.F. modulator
- Cassette interface
- High and low resolution colour graphics
- 64K, RAM 24K ROM
- Comprehensive operation manual

3 MONTH FULL WARRANTY
COMPLETE BACK UP OF
SPARES AND SERVICE FACILITIES
GUARANTEED BY EMONA FOR
A MINIMUM OF 3 YEARS.



COMPUTER AND KEYBOARD
FOR ONLY

\$749*

**A.C.T.
WINCHESTER
AND NETWORKING
AVAILABLE**

Comprehensive operational manual
and programming manual supplied
with each computer
Technical reference manual available

SOFTWARE AVAILABLE

OVER 200 software programmes are readily available with a broad range of applications from business to entertainment. Examples:

Business
Business forecasting model; Calcstar; Cardbox; Context Connector; Datastar; Home accountant; Infostar; PFS; PFS Report; PFS graph; Quickcode; DBASE II; dGRAPH; d util; DBPLUS; Executive briefing system; Desktop Plan II; Versacalc 16; Versaform; Versaform Pascal Interface; Visicalc; Visidex; Visiword; Visitrend/Visiplot; Visicalc Demo; PGE plus PLE; QBase; Supersort: the Consolidator; Cashier; DMS; Plot; Data Base; Data Star; Super Calc; Padmede debtors ledger; Invoicing System; Stock Control System; Creditors Ledger and General Ledger; Multiplan; Inventory; and many others.

Word Processing
Wordstar; Mailmerge; Spellstar; Sensible Speller; Bank Street Writer; Magi Words; Magic Window II.

GRAPHICS
COMMUNICATIONS
UTILITIES
EDUCATION
GAMES

Over 150 titles covering
these categories



PRINTER BARGAINS

**2001
DISKETTE
STORE**

Make diskette storage simple and convenient with the 2001 Diskette Store. The patented mechanism of the 2001 lifts the diskettes for easy identification and access. Capacity 50 x 5 1/4" diskettes.

ONLY

\$58.80
TAX INCLUDED

DISKETTES
5 1/4" SS/DD
SKC. BRAND

\$33
TAX INC

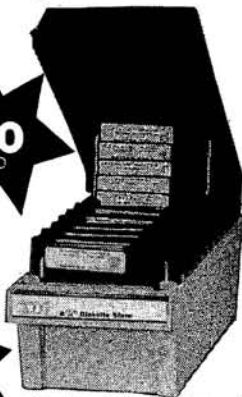

Genuine dealer inquiries welcome

EMTEK EX-80



\$290*

- 80 characters/sec
- Dot matrix
- Bit image graphics
- Bi-directional
- Single sheet or continuous Tractor Feed
- Centronics parallel; interface (serial interface optional)

SAKATA SP 1000



\$399*

- Clearly formed dot matrix characters — 9-11 dots
- 12 variations of character printing within the same line including graphic printing
- Paper cutting edge 2cm from printing position
- Print-on fanfold, single sheet and roll paper
- Back feeding of paper
- Bi-directional printing
- Operator replaceable print head (no special tools required)
- Longer ribbon life (2.5 million characters)
- Centronics parallel and RS-232C Serial interfaces both included.

* ADD 20% SALES TAX IF APPLICABLE

MICROPROFESSOR REG TRADEMARK OF MULTITECH INDUSTRIAL CORP.

APPLE Reg Trade Mark of APPLE Computers Inc.
CP/M Reg Trade Mark of Digital Research Inc.



EMONA COMPUTERS PTY LTD
"THE TECHNOLOGY HOUSE"

NATIONAL AUSTRALIA BANK BLDG.
2nd Floor, 661 George St., Sydney, N.S.W.
Ph: (02) 212-4815 or 212 3463

C·O·M·M·U·N·I·C·A·T·I·O·N·S

by representatives who seemed familiar with business systems or essentially arcade type game machines. Some reps were honest enough to say "I only have business machines". Most others tried to bluff their way. They succeeded in confusing people, not enlightening them.

There was little education software. This is what people had come to see. Mostly the software was of GeeWhiz programs or the plug in arcade type. These programs do not impress concerned parents. After much searching I came to one stand, in the furthest classroom devoted to education software. The only such stand at the Fair! I spoke at length to the sales person. He lamented the lack of interest in good educational

software. Of all the sales persons, he seemed the only one with any concept of how computers can help in education. Unfortunately, the margins he said were not available in selling software, especially as there is no copyright law in Australia at present. Just as people would soon lose interest in record players if there were not a readily available supply of good records, so they will if the imbalance between software and hardware is not quickly corrected.

I suggest that in future school computer fairs, companies should use school children to demonstrate what their machines and software can do; not business or arcade games sales persons. This would give credibility that the sales representatives at this fair

mostly did not display. As students are cheaper to employ, more could be on hand to demonstrate on an individual basis. This would also give the computer students an introduction to the real world of computers.

Also the organisers of Computer Fairs should make sure the emphasis is on software, not hardware. Companies should be given incentives, most likely financial, to display useful programs and not just hardware running inappropriate software.

If Computer Fairs continue to confuse parents as this one did, I feel that the public will rapidly lose their fascination for computers.

D Butler

Bug answered

In the December issue of TJ's Workshop Tim Hodges wrote in wondering why the program in chapter 18 (of the Spectrum manual) was being upset by pressing CAPS-SHIFT 5 a few times.

There is a fairly simple explanation for this occurrence: CAPS-SHIFT 5 is read as CHR\$(8). This is a standard ASCII code for cursor left. To demonstrate what happens when you PRINT CHR\$(8) type in this program.

```
10 PRINT AT 0,0;"hello  
   there 123456";  
   CHR$(8);CHR$(8);
```

```
15 PAUSE 40  
20 PRINT "XxX"
```

You can see that PRINTING CHR\$(8) moves the PRINT position one to the left.

In Tim Hodges program

**Thinking
about
your
IBM PC/XT**

Want one or have one?
Need to talk to experienced
people who understand
your business?
Looking for application software?
Want to NETWORK your systems?
Need training on LOTUS, dBASE 2, PC DOS?
You should be talking to us.

**THINK
COMPUTERS**

602 Maroondah Hwy, Mitcham, 3132
Phone: (03) 873 1122

PLEASE SEND FURTHER INFORMATION **IBM PC/XT**
NAME
COMPANY NAME
ADDRESS
PHONE

TANDY ELECTRONICS DEALER

DISCOUNTS ON ALL TANDY COMPUTERS AND ACCESSORIES

Free delivery throughout Australia.
90 day Warranty
Bankcard & cheque orders accepted.

Bayne & Trembath

3 Boneo Rd., Rosebud, Vic 3940
Ph: (059) 86-8288, A/H (059) 85-4947
(TANDY DEALER 9320)

C·O·M·M·U·N·I·C·A·T·I·O·N·S

```
10 IF INKEY$ <>" "
   THEN GOTO 10
20 IF INKEY$ = " "
   THEN GOTO 20
30 PRINT INKEY$
40 GOTO 10
```

When you press CAPS-SHIFT 5 the program PRINTs CHR\$(8), moving the print position off the screen! This sometimes makes a mess of the display file, which in turn affects everything in RAM, including the program.

T Richardson



Sexist 1

As a woman and leasee of an Apple IIe I do object to the cover of your magazine December 1983. Could I remind you that sex and women's bodies are not

needed to sell computers. While I agree that both are fascinating we women, and I hope you men also, do not use our computers to assist our sex lives. (Computer dating aside.) I would hope that in future your magazine will celebrate women's intelligence rather than display our bodies.

Eileen Willis



Sexist 2

I wish to lodge a complaint about the cover of the December issue of *Australian Personal Computer*. I find it offensive that you have used women's bodies (no faces, mind you) to sell your product and I consider that it reflects

poorly on you and your magazine.

The computer industry is at present dominated by men and I believe women should be encouraged to the industry. This kind of advertising can only serve to alienate women. It undermines the intelligence and competence of women working with computers by relating women's bodies and no other attributes to computers. (By the way, how do you consider women's bodies and computers relate?)

By assuming a sexist male readership you make another mistake. This year Australia's Businesswoman of the Year was a woman working in the computer industry and you will do well to remember that there are many women, and men too, in the industry and using computers in the

home, who find this kind of advertising distasteful.

Fiona Hardie



A nice pair

As a regular subscriber to APC, I must congratulate you on the front cover of the December issue. The design showed a most delightful pair (of computers) in fine detail. I hope you will continue with a similar "do it anywhere" theme on future covers and perhaps offer the two sales representatives a further opportunity to display their merchandise in future issues of the magazine. Well done APC!

S Langford



SOFTWARE RENTAL

NOW YOU CAN RENT THE MOST POPULAR GAMES — EDUCATIONAL — BUSINESS SOFTWARE FROM:



At only 20%-25% of the current retail price + Postage & Packing

- All software in original manufacturers packaging.
 - No minimum quantity.
 - Rentals are for 7 days (plus 3 days grace for return shipping).
- We will endeavour to obtain any software requested.

To immediately order, or for more information ring:

S. D. COMPUTER RESEARCH

1/4 SOUTH STREET, EDGECLIFF 2027
Telephone: (02) 328-6293

COMMODORE 64

SOFTWARE FANTASTIC OFFER!

12 PROGRAMMES FOR \$10.00

• GAMES • UTILITIES • APPLICATIONS

THAT'S RIGHT ... 12 COMMODORE 64 programmes on cassette for only TEN DOLLARS!!! That's about half the amount that you'll expect to pay for just one programme.

WHAT AN OPENING OFFER!!!!

PLUS You'll regularly receive details of all the fantastic new software and hardware available from dozens of overseas sources at tremendous discount prices.

Free Post No 4. G.S. WEBBER & ASSOCIATES: P.O. Box 238, Gympie, 2227. No stamp required. Please send ONE CBM64 multtape to:

Name

Address

..... P/Code

I enclose \$10 as full payment by Cheque P/Order

Bankcard No.

Expiry Date Signature

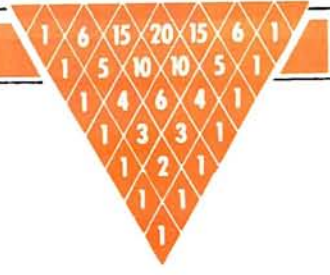

Number theories

New readers start here. The topics dealt with in this column attempt to reach the frontiers of knowledge in number theory with the minimal background information.

The problems posed therefore have no complete solution known to the author, and readers are encouraged to submit their attempts at solution, however incomplete they may seem.

This month we look back and examine some number theoretic results which were making the news around the turn of the century. We ask how these might be established using a digital computer, and in what ways they may be extended.

The results, which require no understanding of mathematics beyond elementary arithmetic, are given in chronological order and readers are invited to respond to some, or all of them!

(a) In 1876 AB Evans found four integers whose sum is a sixth power, and such that the sum of any three is a fifth power.

(b) In 1895 several writers found two integers whose sum, difference and difference of their squares are all twelfth powers.

(c) In 1898 GBM Zerr found six positive integers x_1, x_2, x_3, x_4, x_5 and x_6 such that each, diminished by $(5/2)(x_1 + x_2 + x_3 + x_4 + x_5 + x_6)^5$ becomes a fifth power, and three years later three numbers in arithmetic progression (A, A+d, A+2d, where A is the smallest and d the common difference of arithmetic progression) whose sum is a sixth power.

(d) In 1904 PF Teilhet verified that every integer, A, up to 600, with one exception is a sum of two squares and two positive or zero cubes.

(e) In 1917 R Goormaghtigh stated: 'For A less than 1000000 $A=1 + x+X^2+x^3+...+x^n=1+y+y^2+y^3+...+y^m$ holds only in two cases, one of which is $31=1+5+5^2=1+2+2^2+2^4$.'

Readers are invited to submit a program, or suite of programs, to recreate the news items listed above, and to extend them in any way. Thus in (d) the exception should be displayed and, hopefully, the bound on A significantly extended, while in (e) the second case should be found explicitly and, again, the bound extended on A.

A prize will be awarded to the 'best' entry received by 15 May, 1984. Please address all entries to Mr M R Mudge, C/- Australian Personal Computer, 77 Glenhuntly Road, Elwood, Victoria 3184.

Note. Criteria of judgment include limitations imposed by hardware and programming language chosen, so details of these should be supplied.

Review — November 83

The concept of a *Perfect Number* appears to be well known to many APC readers, hence the peak in response to this article.

The problem of finding factors of an integer is recognised by many, but few address themselves to it. The use of the Chinese Remainder Theorem may provide a 'best possible' algorithm, but personally I doubt this. Discussions with Dr R Churhouse and Dr AOL Atkin many years ago at the Atlas Computer Laboratories, in the presence of my colleague Dr D Ridout, revealed that there was still an unsolved problem in this area.

The Poulet sequence has been displayed by many correspondents — some suggested problems include:

- (1) Are all abundant numbers divisible by 15 if they are odd?
- (2) Are there any three-ply Perfect

Numbers different from 120 and 672?

Therefore, does there exist an n for which $(n)=kn$, k greater than 2 defines a k-ply Perfect Number.

The winner is Mr J Jones. He has taken this problem to the limit of his available hardware, changing the programming language on the way.

Once again, it should be observed that many submissions were of the highest possible standards of neatness; however, I claim to recognise valuable work among other submissions, and ask that you are not put off by the lack of a word processor.

A number m is said to be:
 2-hyper-perfect if $m=2s(m)-1$
 3-hyper-perfect if $m+3s(m)-2$; and in general
 h-hyper-perfect if $m=n s(m) - (n-1)$.

D Minoli has constructed (1980) a list of all n-hyper-perfect numbers (n greater than 1) up to 1500000 using the PDD 11/70 computer.

Can anyone improve upon this situation?

Note. Submissions will only be returned if a suitable stamped addressed envelope is provided.

EMERALD HILL COMPUTER BROKERS

The Computers with above average intelligence

IQ150
 Costs only
\$987.00

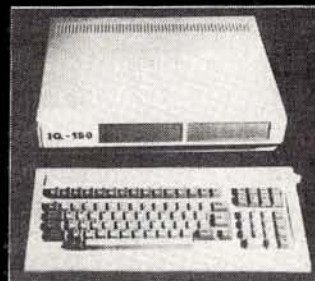

NEW
IQ140
 in standard casing
 Costs only
\$700.00

FEATURES:

- Dual processors, 6502 & Z80
- Programmable Keyboard
- 64K RAM
- Upper and Lower case
- Both include Sandy's Word Processor and a Financial Package

Ring now for next day delivery. Phone: (03) 690 8095
294 Kingsway, Sth Melbourne, Vic 3205

International Books and Magazines for a variety of Computers now available on subscription.

BOOK SUBSCRIPTIONS

APPLE	PRICE		PRICE		PRICE
<input type="checkbox"/> 33 New Apple Computer Programs for Home, School and Office	\$14.95	<input type="checkbox"/> The Colossal Computer Cartoon Book	\$9.95	<input type="checkbox"/> Texas Instruments Home Computer Graphics Programs	\$14.95
<input type="checkbox"/> 101 Apple Computer Programming Tips & Tricks	\$14.95	<input type="checkbox"/> Katie and the Computer	\$15.95	<input type="checkbox"/> 36 Texas Instruments TI-99/4A Programs for Home, School & Office	\$14.95
<input type="checkbox"/> Apple Computer Program Writing Book	\$7.45	<input type="checkbox"/> Be a Computer Literate	\$8.95	<input type="checkbox"/> 101 Programming Tips & Tricks for the Texas Instruments TI-99/4A Computer	\$14.95
<input type="checkbox"/> Write your own Apple Games		IBM		<input type="checkbox"/> Texas Instruments Home Computer Idea Book	\$16.95
<input type="checkbox"/> The Creative Apple	\$22.95	<input type="checkbox"/> IBM Personal Computer Program Writing Work Book	\$7.45	<input type="checkbox"/> Texas Instruments Computer Program Writing Work Book	\$7.45
<input type="checkbox"/> Logo an Introduction	\$14.95	<input type="checkbox"/> New IBM PC Computer for Kids	\$8.95		
<input type="checkbox"/> Computer for Kids	\$8.95	<input type="checkbox"/> User Guide with Applications for the IBM Personal Computer	\$37.95	TRS 80	
<input type="checkbox"/> Visicalc for the Apple II Plus Computer	\$35.95	<input type="checkbox"/> Data and File Management for the IBM Personal Computer	\$35.95	<input type="checkbox"/> The Creative TRS 80	\$22.95
ATARI		<input type="checkbox"/> Introduction to Graphics for the IBM Personal Computer	\$34.95	<input type="checkbox"/> More Basic Computer Games	\$14.95
<input type="checkbox"/> 101 Atari Computer Programming Tips & Tricks	\$13.45	<input type="checkbox"/> Advanced Users of Visicalc for the IBM Personal Computer	\$35.95	<input type="checkbox"/> 55 More Color Computer Programs for the Home, School & Office	\$14.95
<input type="checkbox"/> Atari Computer Program Writing Work Book	\$7.45	<input type="checkbox"/> Visicalc for the IBM Personal Computer	\$35.95	<input type="checkbox"/> 55 Color Computer Programs for the Home, School & Office	\$14.95
<input type="checkbox"/> 31 New Atari Computer Programs for Home, School & Office	\$14.95	SINCLAIR		<input type="checkbox"/> TRS 80 Model 1/111 Computer Program Writing Work Book	\$7.45
<input type="checkbox"/> The Creative Atari	\$22.95	<input type="checkbox"/> 37 Timex 1000/Sinclair ZX-81 Computer Programs for Home, School & Office	\$14.95	<input type="checkbox"/> TRS-80 Color Computer Program Writing Work Book	\$7.45
<input type="checkbox"/> Computers for Kids	\$8.95	<input type="checkbox"/> Timex/Sinclair Computer Game Programs	\$14.95	<input type="checkbox"/> 44 Programs for the TRS-80 Model 100 Portable Computer	\$14.95
CP/M		<input type="checkbox"/> 101 Timex 1000 Sinclair ZX-81 Programming Tips & Tricks	\$14.95	<input type="checkbox"/> Visicalc for the TRS-80 Model 11 and Model 16 Computer	\$34.95
<input type="checkbox"/> Programmers Guide to CP/M	\$24.95	<input type="checkbox"/> Timex/Sinclair Computer Program Writing Work Book	\$7.45	<input type="checkbox"/> Visicalc for the TRS-80 Model 11 & 111 Computer	\$34.95
COLOR COMPUTER		<input type="checkbox"/> Timex Sinclair 1000 Idea Book	\$16.95	<input type="checkbox"/> Guide to Systems Applications with Programs for TRS-80 Models 1 & 111	\$35.95
<input type="checkbox"/> Color Computer Graphics	\$14.95	<input type="checkbox"/> 50 Programs for the Timex/Sinclair 1000	\$13.95	<input type="checkbox"/> Techniques of Basic for the TRS-80 Models 1 & 111	\$36.95
<input type="checkbox"/> 101 Color Computer Programming Tips & Tricks	\$11.95	<input type="checkbox"/> Creative Games for the Timex/Sinclair 2000	\$15.95	<input type="checkbox"/> Data Management Techniques with Programs for the TRS-80 Models 1 & 111	\$34.95
GENERAL		<input type="checkbox"/> The Gateway Guide to the ZX 81 & ZX 80 - Revised Edition	\$15.95	<input type="checkbox"/> Introduction to Graphics for the TRS-80 Models 1 & 111	\$33.95
<input type="checkbox"/> Computer Parade	\$15.95	<input type="checkbox"/> Getting Acquainted with your ZX81 Third Edition	\$15.95	VIC 20 & 64	
<input type="checkbox"/> Basic Computer Games	\$15.95	<input type="checkbox"/> The ZX81 Companion	\$15.95	<input type="checkbox"/> Getting Acquainted with your VIC-20	\$15.95
<input type="checkbox"/> Big Computer Games	\$15.95	<input type="checkbox"/> The Best of Sync	\$16.95	<input type="checkbox"/> Computer for Kids	\$8.95
<input type="checkbox"/> The Computer Controller Cook Book	\$19.95	<input type="checkbox"/> Computer for Kids	\$8.95	<input type="checkbox"/> Vic-20 Computer Program Writing Work Book	\$7.45
<input type="checkbox"/> Computers for Sea and Sky	\$16.95	<input type="checkbox"/> Practical Timex/Sinclair Computer Programs for Beginners	\$11.95	<input type="checkbox"/> 34 Vic-20/Computer Programs for the Home, School & office	\$14.95
<input type="checkbox"/> Computers in Science and Social Studies	\$19.95	TEXAS INSTRUMENTS		<input type="checkbox"/> Vic-20/Commodore 64 Computer Programs for Beginners	\$14.95
<input type="checkbox"/> Computer in Mathematics	\$19.95	<input type="checkbox"/> Texas Instruments Home Computer Games Programs	\$14.95		
<input type="checkbox"/> Problems for Computer Solution (Student Edition)	\$8.95				
<input type="checkbox"/> Problems for Computer Solution (Teacher Edition)	\$16.95				
<input type="checkbox"/> Tales of the Marvellous Machine	\$14.95				
<input type="checkbox"/> The Impact of Computers on Society and Ethics	\$24.95				
<input type="checkbox"/> More Basic Computer Games	\$14.95				
<input type="checkbox"/> The Best of Creative Computing Vol 1, 2, 3	\$15.95				

MAGAZINE SUBSCRIPTIONS

APPLE	PRICE	ATARI	PRICE	IBM	PRICE
<input type="checkbox"/> Incider	\$5.25	<input type="checkbox"/> Compute	\$5.25	<input type="checkbox"/> Personal Computer Age	\$4.50
<input type="checkbox"/> Apple Orchard	\$4.50	SINCLAIR		<input type="checkbox"/> P.C.	\$6.50
<input type="checkbox"/> Nibble	\$5.25	<input type="checkbox"/> Compute	\$5.25	<input type="checkbox"/> P.C. World	\$5.25
<input type="checkbox"/> Compute	\$5.25	<input type="checkbox"/> Sync	\$4.50	<input type="checkbox"/> P.C. Jnr	\$5.25
<input type="checkbox"/> Macworld	\$6.50	CP/M		<input type="checkbox"/> Jnr	\$5.25
PORTABLES		<input type="checkbox"/> Microsystems	\$4.95	TRS COLOR COMPUTER	
<input type="checkbox"/> Portable Computer	\$4.95	TI 99/4A		<input type="checkbox"/> Hot Coco	\$4.50
VIC-20 & 64		<input type="checkbox"/> 99'ER	\$5.95	<input type="checkbox"/> Rainbow	\$5.25
<input type="checkbox"/> Run	\$4.95	<input type="checkbox"/> Compute	\$5.25	<input type="checkbox"/> Compute	\$5.25
<input type="checkbox"/> Computes Gazettes	\$4.95	TRS 80		GENERAL	
<input type="checkbox"/> Compute	\$5.25	<input type="checkbox"/> 80 Micro	\$6.50	<input type="checkbox"/> Micro Computing	\$4.50
				<input type="checkbox"/> Compute	\$5.25

To order simply tick the box beside the appropriate Book or Magazine and send your remittance to:

CPM DATA SYSTEMS PTY LTD

184A BARKLY STREET, FOOTSCRAY 3011, P.O. Box 211,
 FOOTSCRAY 3011 (Free Post No. 6)
 Telephone: (03) 687 6790, 689 8690

Please send me the Books/Magazines ticked. I enclose my remittance for \$.....

Name

Address

..... Postcode

Bankcard Number

Expiry Date Signature

B · I · B · L · I · O · F · I · L · E

Steve Withers' selection from the bookshelf features a hand-drawn tutorial from Donald Alcock and a revealing guide to Radio Shack's Model 100.

Illustrating Computers

Since you are reading this column, it is fairly safe for me to assume that you know what a computer is, and (to some extent) how it works. That being the case, you are probably asked questions on such subjects from time to time. If you get tired of answering them, you could do worse than directing the questioner to "Illustrating Computers (without much jargon)" by Colin Day and Donald Alcock.

This book is unusual in that instead of being typeset it reproduces Donald Alcock's amazingly legible handwriting. The bulk of the informative and often witty illustrations are also his work, although there are a few photographs showing what a "chip" actually looks like.

The book deals with computers from first principles, asking "why bother about them?", and offering a very plausible answer: "only with this knowledge [of how they work] can one judge both the potential of computers and their limitations. Any mystery surrounding computers can be dispelled only by giving some explanation of the way they

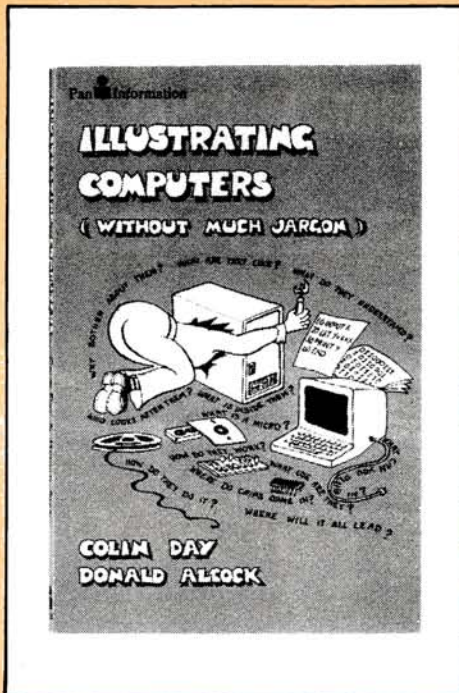

go about their work."

The subject of coding is introduced very early in the book. The idea of a binary representation is presented by a row of cats heading towards their dinner —

some have their tails up (1s), while the rest have them down (0s). The way in which a computer works is explained at a very low level, building from simple logic elements like AND gates through adding circuits. The fabrication of integrated circuits is also described, along with a brief history of electronics starting with crystal sets and vacuum tubes.

One of the most valuable sections of Day & Alcock's book describes programming. Unlike many authors, they draw a distinction between the languages that a computer "understands", and those it may appear to understand, in other words between machine languages and programming languages. The significance of this depends on the readers purposes, but as the authors have set out to explain the nature of computers it is an important point.

This is the best book I have seen for people who want to know about the nature of computers as opposed to their applications or the task of programming them.

Illustrating Computers (Without Much Jargon)

Authors: Colin Day and Donald Alcock
Publisher: Pan, London and Sydney
Price: \$4.95

The Companion to the BBC Micro

Now the ABC are showing "The Computer Programme" in the evening, it's likely that interest in the BBC micro will increase. A look in almost any bookshop shows that many publishers are ready to cope with the rush.

Geoff Wheelwright's "Companion" stands out from the crowd. It's not just another "teach yourself Basic", or a pottered collection of games. Instead it is a guide to some of the things you could do with a BBC.

One of the earlier chapters describes the various kinds of games available for the Beeb. Everyone and his dog knows about Pacman and Space Invaders, but newcomers to computing (particularly

those who are still undecided about buying a micro) may not have heard about adventurous games and classics like Star Trek, and it is unlikely that they would realise how impressive and entertaining a flight simulator can be.

Various aspects of the BBC's hardware are discussed, including a brief walk-through of the basic features like the Tube (which allows the installation of a second processor), the analogue to digital converter, and the various interfaces. This book doesn't tell you everything you need to know about these items, but it does explain why they are there.

Some hardware features are given more detailed coverage, especially communications and mass storage. The communications chapter is mainly a description of Econet (Acorn's proprietary networking system) but Wheelwright also discusses Prestel and Micronet

which are of interest only to users in the U.K., and briefly mentions the possibility of connecting a BBC to another micro through the serial port.

Turning to mass storage, there are some useful hints on choosing a cassette recorder — I got the feeling that the author tried several before he found one he was happy with. The relative advantages of the alternatives to cassette storage are discussed, including high-speed tapes and various disk systems from Acorn and other manufacturers. I'm not sure how many of these products are on sale here.

Getting back to software, word processing gets a chapter to itself. As in the other sections of the book the object seems to be to make potential buyers aware of the difference between products in the various price ranges.

Programming isn't ignored by the

"Companion", although it isn't given the prominence it often receives. Snatches of BBC Basic are dotted around the book, and several of its distinctive features are described. A collection of useful routines and reference material is presented in the appendices. Mention is also made of three other languages for the BBC — Lisp, Forth, and BCPL — all of which may be purchased as plug-in ROMs.

The "Companion" is a useful book for novices, and given its modest price few buyers will be disappointed if it doesn't live up to its claim to be "the complete reference companion for all BBC users". Would you expect a book of 120-odd pages to be an encyclopaedic guide?

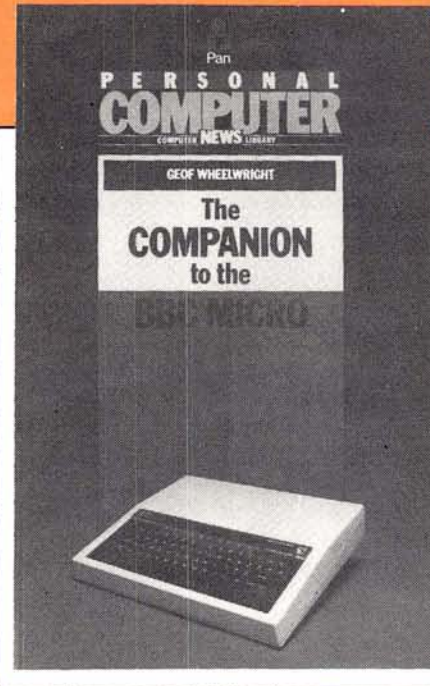

There is one sentence that really deserves quotation: "All chip-based software should, of course, be treated with great respect when it's installed." I can just imagine users switching on their micros and saying "good morning, spreadsheet (or whatever), do you feel like working for me today?"

The Companion to the BBC Micro

Author: Geof Wheelwright
 Publisher: Pan/Personal Computer
 News, London and Sydney
 Price: \$14.95

The Radio Shack Notebook Computer

As interest is growing in extremely portable computers, it is inevitable that books describing various models should start to appear. The first to reach me is this one about Tandy's Model 100 portable.

The main problem with books of this type is that they are generally little more than extensions of manufacturers' advertising material. The tests of their usefulness must be whether they help an intending buyer make a reasoned decision, and whether they contain helpful information for new users.

I'm in the market for a portable (I'm actually writing this with pen and paper!) so I tried to look at the book from both angles. The main problem with Kellogg's book is that it is unashamedly American, and the distributors haven't bothered to provide an Australian supplement. The main differences relate to communications, as the Model 100 sold here doesn't have the built-in auto-dial modem, and few people can afford to log onto US dial-up services like Compu-Serve. On top of that, I would have thought that there would be Australian sources for some of the programs, accessories, and magazines mentioned. Despite this, the book could still offer value for money.

For example, one of the appendices is a collection of Basic programs — some look useful (like a print formatter) others



are just for show (how to make your Model 100 play "Doh, a deer"). This section of the book provides a few handy tips as well as the program listings. The title "Programs for Non-programmers" is very apt, but I can't help feeling that it's likely to encourage some readers to learn. Basic. After all, if you can do something useful in a dozen lines or so, it can't be all that difficult, can it? . . .

The first built-in program introduced is TEXT, the text editor. This makes a lot of sense, because the other programs act on files that you create using TEXT. The

fact that TEXT is an elementary editor means there isn't much to be said about it, but Kellogg says it well. He avoids cuteness, uses examples to which his audience will relate, and includes warnings at appropriate points. The other programs (schedule organiser, address organiser, and communications) are given similar treatment.

So far, this is all routine (if good quality) material for a book that describes a particular personal computer. But what are we to make of a chapter titled "Managing Your Work and Your Life with the Model 100"? Basically, the idea is that you create a "to-do" list in a particular format using the editor, sort it into chronological order, yank out "today's" items, pretty them up, and finally print the list.

There are also higher-level suggestions for self-management. Procedures are suggested for recording ideas, turning them into projects, identifying individual tasks, and getting those tasks into the daily "to-do" lists. I've often thought that my work would benefit if I were better organised, but the time and effort involved in pencil and paper methods always put me off. Maybe a notebook sized computer and this book are what I need.

The Radio Shack Notebook Computer

Author: Orson Kellogg
 Publisher: Sybex, Berkeley, CA, USA
 Price: \$15.50

If a picture's worth a thousand words...



SPECTRAVIDEO 328



COMMODORE SX64



COMMODORE 64

THE LARGEST
RANGE OF
64 SOFTWARE
IN AUSTRALIA



STAR GEMINI 10X
C/64 Compat. with VICS Print 64



KOALAPAD
TOUCH TABLET



SPECTRAVIDEO 318
FULL RANGE OF SOFTWARE
AVAILABLE.



You can't say we didn't tell you that the Spot has the largest range of C64 software, plus a wide selection of hardware from the leading manufacturers - at the most competitive prices.

With expert advice and reliable service.

Thinking personal computing? Then there's only one Spot... sorry two!

the
Computer Spot

9 MLC Centre, Martin Place
Sydney. Phone: 235 2971.
Eastgate Centre, Bondi Junction
Phone: 358 5208.

Spectravideo

With software standardisation currently being a moot point in the computer industry, the implementation of the much discussed MSX system on the Spectravideo home computer could change the face of things to come.

Tony Hetherington looks over the machine and pontificates on its worldwide repercussions.



The Spectravideo home computer is the first MSX machine to reach these shores. It represents a truly international venture since it was designed at the Spectravideo head office in New York, uses MSX Basic written by Microsoft in Japan and is built by Spectravideo in Hong Kong.

There are two different models available: the SV-318 which features a built-in joystick and the more expensive

SV-328 which offers 80k of RAM and a full-size keyboard. In their simplest form they are powerful home computers offering superb sound and graphics facilities. However, the machines can be expanded into disk systems using the industry standard CP/M operating system.

Hardware

The Spectravideo computer is housed in

a white, plastic case which measures 39.4cm x 22.1cm and slopes from a height of 7.6cm at the back to 4.3cm at the front.

The top of the machine is dominated by the keyboard which fills about two thirds of the space with the rest consisting of a raised section housing a cartridge slot. Along the rear of the case is the video output port, the cassette port and an expansion port designed to

BENCHTEST

accept the Super Expander (more about this later). The nine volt power input is on the right hand side along with an on/off switch and two joystick ports.

The SpectraVideo is connected to a standard television set by a generous 1.5m cable travelling via an external TV modulator to a video switch box. The power is supplied by a heavy duty unit which supplies nine volts at 1.5 amps, which is sufficient to drive the computer, a cassette recorder and one other peripheral.

The SV-318's keyboard consists of 71 rubber keys and a built-in joystick. The keys are well spaced out which makes them easy to use and a great improvement on the other rubber-keyed computers currently on the market. This ease of use is enhanced by the inclusion of a space bar and two shift keys.

In addition to the standard keys found on a machine in this price bracket are five function keys, three program control keys and six miscellaneous keys.

Each of the five function keys can execute one of two functions depending on whether or not the Shift key is pressed. The functions to be executed are displayed at the bottom of the screen display. All are user-definable but the keys are preset to functions such as RUN, LIST and CLOAD.

The three program control keys are: ENTER; STOP to halt a program; and the CONTROL key which facilitates the CTRL commands (for example, CTRL-S).

Finally, the other keys are: CAPS LOCK, complete with a red LED, CLS/HOME, which clears the screen and returns the cursor to the home position; INSERT and DELETE for program editing; and LEFT and RIGHT GRAPHIC. These last two keys are used to select either of the two graphics characters printed above each of the alphabetic keys.

To the right of the keys is the built-in joystick. This is only a four direction stick and is used mainly for editing. The stick itself is inserted into a grey circular pad which can be used more easily without the stick in place.

The SV-328 differs from its cheaper brother in its amount of memory and in the quality of its keyboard. It boasts a full-size, 86-key, typewriter-style keyboard with the SV-318's joystick being replaced by a numeric keypad

complete with arithmetic and cursor keys.

Early sales literature from SpectraVideo claimed that the SV-328 had a built-in word processor and HELP programs. These were, however, discarded in favour of full MSX status but have left their mark in some now useless keys. The SV-328 has an unresponsive PRINT key and both machines have a select key which has no apparent use.

The size of the top of the keys on the SV-328 is the same as SV-318's rubber keys, but since the plastic keys taper out, the keyboard of the SV-328 seems to be rather cramped. Also there is no room to show the available graphics characters.

The inside of the machines is definitely a 'no go' area since it is encased in a

metal box, held in position by several screws which are in turn sealed by dollops of red plastic.

Cassette player

The cassette player is a dedicated recorder which connects to the back of the computer via a cable which houses power, audio, digital and motor control lines.

The player itself is a rather ugly looking machine. Its straight front and angled sides give it a distorted appearance and the dull brown keys and cassette cover do nothing to improve this image. However, this doesn't stop it being a very good cassette player which is just as well since it's the only recorder you can use with the SpectraVideo.

As it's a dedicated recorder it doesn't



The SV-328 boasts a full-size, 86-key, typewriter-style keyboard



The SV-318 keyboard consists of 71 rubber keys and a built-in joystick

WHEN IT COMES TO PERSONAL COMPUTER SPECTRAVIDEO™ IS BEYOND ANY COMPARE!



To the delight of our customers, and the dismay of our competitors, we now proudly present the most advanced, most capable personal computer system available today: SpectraVideo™'s SV-318 and SV-328. While the SV-318 is "everything home computer users were waiting for," the SV-328 is specially designed "for the small business that doesn't plan to stay that way." These 2 computers, too, are beyond any comparison in their price range.

And they do not stand alone. Seldom, if every, has a new computer been supported by so many peripherals. Of exceptional quality, all this hardware rides into you on the crest of the very last

technology. Additionally — and importantly —

SpectraVideo™ is very software oriented. With built-in CP/M compatibility, the SV system allows you to take advantage of thousands of pre-existing programs. And with the MSX software compatible standard, jointly launched by SpectraVideo™ and most of Japan's largest electronics firms, SpectraVideo™ can take advantage of all software developed by other MSX participants. Plus, SpectraVideo™ is now producing its own line of top-quality software. Finally, the SV system includes several innovative and interesting accessories that you will want to use.

Because of product depth and ease-of-operation, the SV system will give you

full usage from the moment you unpack it. Yet it is both capable and expandable enough to give you long-term usage, too. That's why SpectraVideo™ is truly, "The computer system you'll grow into, not out of."



software compatible standard

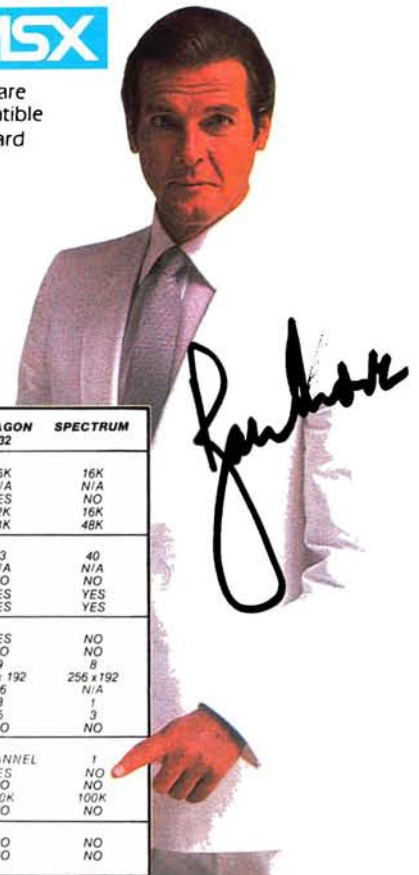

MSX, Microsoft Extended BASIC is a trademark of Microsoft Corporation. CP/M is a trademark of Digital Research Inc.

	SPECTRAVIDEO SV 328	SPECTRAVIDEO SV 318	APPLE II E	ATARI 800	COMMODORE 64	BBC MODEL B	DRAGON 32	SPECTRUM
COMPUTING POWER FEATURES								
BUILT-IN ROM	48K	32K	16K	10K	20K	16K	16K	16K
EXPANDABLE TO	96K	96K	N/A	42K	N/A	64K	N/A	N/A
BUILT-IN EXTENDED MICROSOFT® BASIC	YES	YES	YES	ADDITIONAL COST	NO	NO	YES	NO
BUILT-IN RAM	80K*	32K***	64K	48K	64K	32K	32K	16K
EXPANDABLE TO	256K**	256K**	64K	NO	N/A	32K	64K	48K
KEYBOARD FEATURES								
NUMBER OF KEYS	87	71	63	61	66	73	53	40
USER DEFINE FUNCTIONS	10	10	N/A	4	8	10	N/A	N/A
SPECIAL WORD PROCESSING	YES	YES	NO	NO	NO	NO	NO	NO
GENERATED GRAPHICS (FROM KEYBOARD)	YES	YES	NO	YES	YES	YES	YES	YES
UPPER/LOWER CASE	YES	YES	YES	YES	YES	YES	YES	YES
GAME/AUDIO FEATURES								
SEPARATE CARTRIDGE SLOTS	YES	YES	NO	YES	NO	NO	YES	NO
BUILT-IN JOYSTICK	NO	YES	NO	NO	NO	NO	NO	NO
COLORS	16	16	15	128	16	16	9	8
RESOLUTION (PIXELS)	256x192	256x192	280 x 160	320 x 192	320 x 200	256 x 640	256 x 192	256 x 192
SPRITES	32	32	N/A	4	8	N/A	16	N/A
SOUND CHANNELS	3	3	1	4	3	1	3	1
OCTAVES PER CHANNEL	8	8	4	4	4	3	5	3
A.D.S.R. ENVELOPE	YES	YES	NO	NO	YES	YES	NO	NO
PERIPHERAL SPECIFICATIONS								
CASSETTE	2 CHANNEL	2 CHANNEL	1 CHANNEL	2 CHANNEL	1 CHANNEL	2 CHANNEL	2 CHANNEL	1
AUDIO I/O	YES	YES	NO	NO	NO	NO	YES	NO
BUILT-IN MIC	YES	YES	NO	NO	NO	NO	NO	NO
DISK DRIVE CAPACITY (LOW PROFILE)	256K	256K	143K	92K	170K	100K	100K	100K
	YES	YES	NO	NO	NO	NO	NO	NO
CP/M® COMPATIBILITY (Standard 80 column programs)								
CP/M® 2.2	YES	YES	NO****	NO	NO****	YES	NO	NO
CP/M 3.0	YES	YES	NO	NO	NO	NO	NO	NO

Specifications are subject to change without prior notice
 * 64K user addressable plus 16K graphic support
 ** 240K user addressable plus 16K graphic support
 *** 16K user addressable plus 16K graphic support
 **** Apple II can accept modified 40 or 80 Column CP/M
 ***** Commodore 64 accepts 40 column CP/M

Rose Music P/L 17-33 Market St. Stn Melbourne, Vic 3205 Ph: (03) 699 2388
 Rose Music P/L 28-30 Kent St. Belmont, NSW 2192 Ph: (02) 750 8999
 Sun State Toy Agencies, Room 6/3 Marie St. Milton, Qld.4064 Ph: (07) 369 0496
 Rose Music P/L 196 Gillies St. Adelaide, SA 5000 Ph: (08) 223 3966
 Jerdon Agencies, 25 Gladstone St. E. Perth, WA 6000 Ph: (09) 328 5299
 Dennington Enterprises, 46 Canning St. Launceston, Tas 7250 Ph: (003) 31 8551



BENCHTEST

require any tone or volume controls and therefore avoids the loading problems which plague other home micros. It is under full computer control which is ideal for tutorial style programs as is the facility of a parallel audio track. This can be recorded using the built-in microphone, and play back relevant instructions as a program is loading in.

I generally don't like dedicated cassette players since they add to the expense of buying a micro, but this is quite a good one, and, as I said earlier, it's the only game in town.

Super Expander

Should you wish to expand your Spectravideo computer then you will undoubtedly need the Super Expander. The Expander can be used with both the SV-318 and the SV-328 and it plugs into the large expansion slot at the rear of the machine.

It's slightly larger than the Spectravideo itself but sits neatly behind the computer. Constructed out of the same sturdy, white plastic and consisting of two symmetrical halves, the top half is easily removed to allow access to the insides. It has its own power supply — sufficient to drive up to seven devices — which occupies the right-hand third of the internal space.

Next to the power assembly are

seven expansion slots. These are numbered 0 to 6, with slot 6 being reserved for a floppy disk controller.

To the left of these slots is an area designed to store the TV modulator and any excess aerial lead. The lead is fed in through a hole in the front and out via a slot in the back panel. This is particularly convenient since the top of the Expander is strong enough to support a 15in television.

There are seven other slots cut out of the back panel for any other cables or wires from cards plugged into the expansion slots. Corresponding holes in the front panel are created by removing clipped on plastic panels which can be replaced should the cartridges be rearranged. The front of the cartridge is visible through this opening for ease of use.

Expansion cartridges

Four expansion cartridges were available for review: the floppy disk controller, 16k and 64k memory expansions and a Centronics interface.

Each of the cartridges is enclosed in a standard dark grey case, the bottom of which has a section removed so that the cartridge can be plugged into an expansion slot. The top and front panels have an identifying label. The front panel has an additional LED to

show that all is well. The back of the case is open which spoils its appearance since the enclosed electronic card extends out of the back of the case. This, however, allows easy access to any ports or interfaces for connections to peripherals.

The floppy disk controller has two of these ports since it can support two floppy disk drives and the Centronics interface has a printer port.

The 16k and 64k RAM cartridges can be used to extend the computer's memory up to 128k. This is beyond the addressable memory supported by the Z80 processor and therefore a system of banked switching must be employed. This is done manually by the setting of dip switches on the front of the 64k cartridges.

Floppy disk drive

The hardware available for review is completed by the inclusion of the floppy disk drive. This plugs into the floppy disk controller via a ribbon cable through which it draws its power and transmits and receives data.

The disk drive uses standard 5¼in single-sided, double-density disks and has a formatted capacity of about 164k.

The drive is quite noisy but this is excusable in a machine in this price bracket.

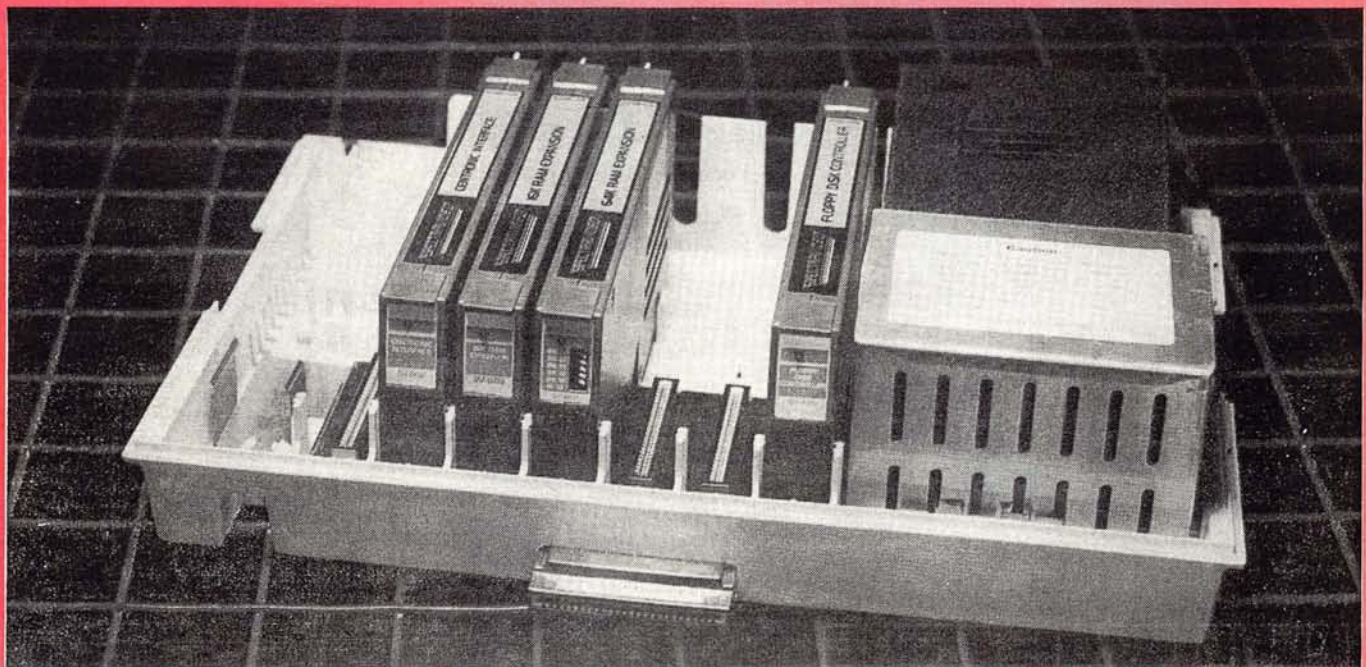

The Super Expander can be used with both the SV-318 and SV-328 and plugs in at the rear of the machine

**"WHY PAY
FOR TEN
WHEN YOU
ONLY
NEED TWO?"**

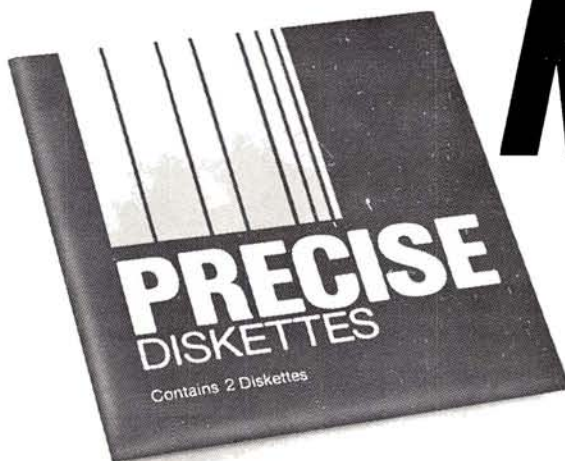
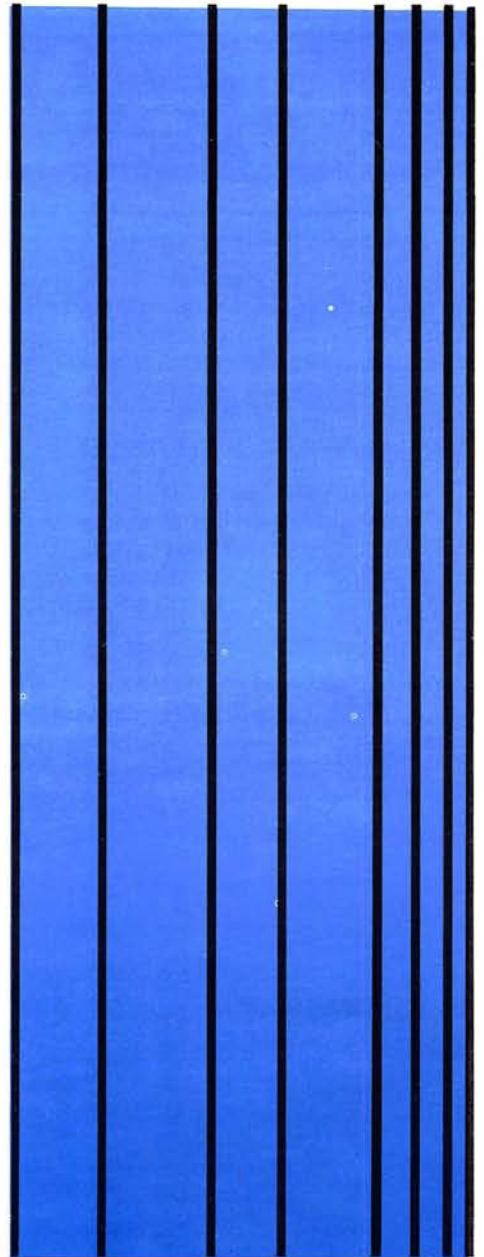
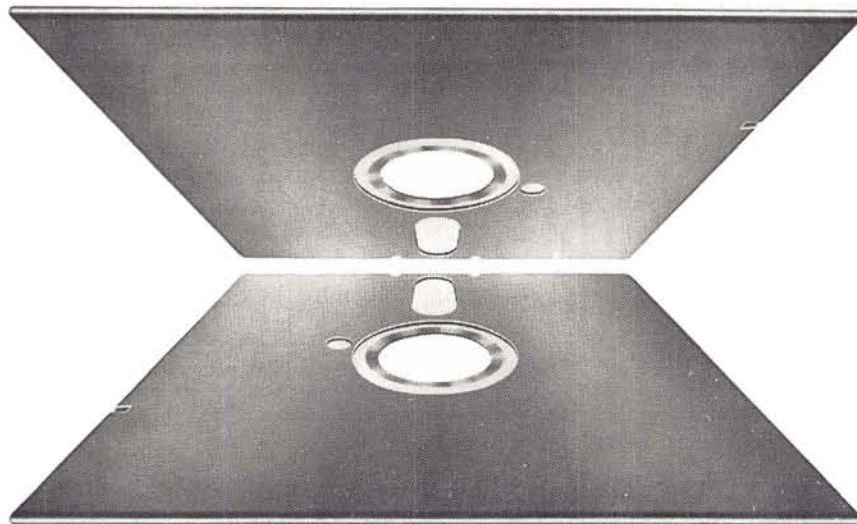

NEW PRECISE DISKETTES

Sometimes you need a full pack of ten diskettes. Other times, ten may be far too many.

Now 3M gives you a choice with new PRECISE Diskettes, available in traditional ten-packs or convenient and economical packs of two.

Whichever pack you choose, you can be sure of exceptional quality, error-free performance — and surprisingly competitive prices.

Why pay for ten when you only need two?

At your stockist now \$10.60 for two, \$48 for ten.

Big savings on Disk Diaries.

Every purchaser of PRECISE Diskettes will be able to buy a handsome and efficient Disk Diary at only \$6.50 (usual retail price \$13.00).

Limited offer — closes March 31.

Results MMM 4267

Data Recording Products Division

3M Australia Pty Ltd (inc in NSW)
Sydney 498 9333, Canberra 47 4322, Melbourne 542 5222
Hobart 34 3104, Adelaide 268 1122, Perth 328 5244
Darwin 81 5645, Townsville 72 3735, Brisbane 391 7844
Newcastle 2 5461

3M

B E N C H T E S T

Up to two drives can be included to form a powerful CP/M-based system capable of many serious applications.

The expandability of the Spectravideo computer extends beyond the hardware supplied for review. Other products include a games adaptor to run Coleco games, a dot-matrix printer, a graphics tablet, an RS232 interface, an 80-column card and a modem.

System Software

When you switch on the Spectravideo the logo is displayed in three colours as the machine performs a diagnostic check. Once completed the screen reverts to its standard display of white text on a light blue background and reports the number of memory bytes free.

The SV-318 has 32k of RAM, although 16k of this is used for the graphics display. A further 3k is used with other system overheads leaving just under 13k for the user.

The SV-328 has just over 29k of user memory displayed but more is actually available. This is because the SV-328 has 80k which is beyond the addressable capacity of the Z80 processor. Therefore memory bank switching has been used so only 48k is in the machine at any time.

MSX Basic written by Microsoft is the operating language used and the facilities described here will be present in any MSX machine.

Writing your own programs is easy with MSX since it includes some features to ease the programmer's burden. AUTO automatically generates line numbers and RENUM renames a finished program. The Spectravideo features a full screen editor which dramatically speeds up editing and correction of errors. Simply position the cursor over the error using the cursor keys or the joystick and correct the mistake.

The preset functions are set to aid the programmer and include RUN and LIST options, even LIST — to list the last line entered — and a colour function to reset the colours to their original setting.

MSX Basic includes most of the usual program structures but there are one or two curious omissions. The oddest of all is the exclusion of the WHILE-WEND structure since the Spectravideo's manual includes two error messages for this structure.

The error messages, should they occur in your programs, are typed out in full on the screen which is a great improvement on Microsoft Basic.

MSX includes a number of very useful interrupt, control commands which can be used to great effect in programs. The most common of these is the ON ERROR GOSUB command which defines the subroutine to be executed should an error be detected. The others have a similar format and include ON INTERVAL which defines a routine which will be executed at set time intervals. ON KEY directs control to one of several destinations depending on which function key is pressed, ON STOP executes a routine when a program is halted by a user and ON SPRITE can be used to resolve collisions between sprites (for example, objects in a game). Finally ON STRIG calls a routine depending on the direction of a joystick.

Each of these interrupt commands can be turned on or off or reset after it has been triggered. Triggering these commands is automatic once they have been initiated and requires no further Basic commands. This will obviously speed up program execution since no Basic statements need be interpreted.

Arithmetically, the Spectravideo is extremely accurate as variables are automatically set to double precision. The price for this accuracy is loss of speed.

The Spectravideo supports a superb range of graphics commands. A single command performs a whole series of operations. For example, the command LINE(10,10)-(100,30),bf draws a rectangle between the two points specified and then fills it in. The coordinates in the example refer to the high resolution graphics screen which consists of 192 x 256 pixels. Each of these pixels can be PSET (set) or PRESET (reset) in any of the sixteen colours.

When the computer is switched on the screen resolution is in low resolution mode (40 x 24) in which only the block graphics characters can be selected using the left and right graphics keys. The SCREEN command is used to switch between screen modes.

Other advanced graphics facilities which you would normally expect to find in an extended Basic cartridge include: the CIRCLE command which

can draw circles and ellipses; PAINT which fills in a graphics shape in a specified colour; GET which stores a specified area of the screen in an array for printing anywhere on the screen using PUT.

The Spectravideo also supports up to 32 sprites at any one time. These sprites can be of two sizes: 8 x 8 or 16 x 16 pixels. The size to be used is selected as a field in the SCREEN statement.

Creation of sprites on the Spectravideo is a lot easier than on other machines, such as the Commodore 64 where details of the sprites' design must be entered into the computer using a series of POKEs. To define a sprite on the Spectravideo all you need do is use the SPRITE command which assigns a sprite with the pattern held in a string of characters that can be easily created through READ and DATA statements.

The Spectravideo also possesses two Macro languages: a graphics macro language (GML); and a music macro language (MML). These are separate mini-languages existing with Basic.

The GML can be regarded as a graphics language similar in nature to Logo's turtle graphics. It consists of a series of single letter commands which are incorporated into the Basic command DRAW. These commands are directions given to a cursor that draws a line on the screen. Each command is followed by a number to complete the instruction. For example, U10 tells the cursor to go up 10 pixels. Other commands include: E,F,G and H to move diagonally; B, to move without leaving a line; A to set an angle; and C to set the colour of line drawn.

MML is similar to GML and provides the Spectravideo's sound capabilities. Quite simply the sequence of notes you wish to play is stored in a string and performed using the PLAY command. The command PLAY "CEG" would play the notes C, E and G. These basic notes can be tuned and modified by additional commands which include O to set the octave, T and L to determine the tempo and length of a note and S and M to control the shape and tone.

Up to three strings can be included in a PLAY command, separated by commas to set the notes to be played by each of the three sound channels.

The sound is generated by a separate chip which means that music can be

dataflex = performance + flexibility

RAM CARDS

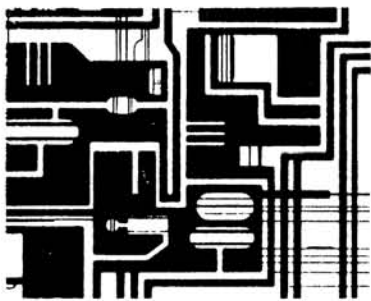

IBM — SIRIUS

PERFORMANCE

Gold edge connections give continuous trouble free operation. Super quality — full 12 month guarantee.

The best of British design.

FLEXIBILITY

Easy installation — simply plug in.

Minimal upgrade costs to a full 512K.

FREE: Magic Memory

Speeds micro by up to 5 x faster with Cache and print spooling.

IBM

64K from \$510.00 and upgrades of 64K @ \$120.00

SIRIUS

128K from \$700 and upgrades of 128K @ \$240.00*

Printers

- EPSON RX-80 ONLY \$490.00
- AMUST P-88 ONLY \$499.00

*ALL PRICES
INCLUDE TAX

dataflex
Better by Design

Dealer Enquiries Welcome

Address: 537 Boundary St.
Spring Hill
Brisbane. 4000

Phone: (07) 229 0066
Telex: AA 41181

STOP PRESS
JUST ARRIVED
IN AUSTRALIA



AGC Monitor

- ★ 360° swivel display
- ★ Super high resolution
- ★ Crisp 80 chr. display
- ★ Non-reflective screen
- ★ Resolution: 1000 lines
- ★ 22 M.Hz band width
- ★ F.C.C. Class B. approved
- ★ Attractive styling

Green Screen — \$210.00*

Amber Screen — \$225.00*



BENCHTEST

produced without slowing down execution time.

This separate sound processor probably explains the difficulties I had in tuning in a television to use with the machine. I found it almost impossible to tune it so that the picture was sharp and the sound still audible. Eventually I was able to reach a balance between sound and vision and had no further problems.

Supplied with the floppy disk controller are two disk-based operating systems, MSX disk Basic and CP/M 2.2.

To be honest I really can't see the point of this version of MSX Basic. It contains only a few additions to the ROM-based version for accessing disks. Besides, the Spectravideo also supports a modified version of CP/M 2.2 which will be more than adequate for the needs of most users.

It can be implemented on a reasonably priced system with the minimum requirement being one floppy disk. To cater for this the CP/M utilities have been rewritten with a 40-column screen display. Additional utilities have been added for the user with only one disk drive including 1COPY which will copy a disk using only one drive. A whole disk is copied in four passes with clear instructions telling when to swap the disks.

Other Software

Commercial software is available for the Spectravideo in three different mediums: tape, cartridge and disk.

The cartridges are enclosed in dark grey cases which extend past the connecting port on three of the four sides. This guides the cartridge into the slot on the top of the machine. The cartridges fit firmly into their slots without being difficult to use by a child.

The cassette tapes are of high quality although any computer tape can be used to save your own programs.

Both the cassette and cartridge programs are supplied in attractive boxes complete with full instructions.

Four programs are included in the price of the machine: two games, or rather entertainment programs, entitled Spectron and Armour Assault, an "Introduction to Basic" course and a "Home Economist" package. Other games are also available and a couple are worth mentioning:

Crossforce is a blast-the-aliens type of game and is a mirrored version of Galaxians. Mirrored, because you control two laser bases, one at the bottom and the other at the top of the screen. The object is to catch the attacking aliens in crossfire between the two laser bases. There are three different ways of controlling the bases, parallel where they move together, diagonal where they move in opposite directions and dual control in which two players can play — each controlling a base.

Armour Assault is a variation of the old tank battle game but it has been brought up to date to form an enjoyable two player game. Eight different variations of the game exist, each different from the others in fuel, ammunition and tanks available to the players. Some options include hospitals to repair tanks and depots where you can refuel tanks and rearm. Others include ghost tanks that try and destroy you.

Frantic Freddy is a rather curious game where you control the fearless fireman Freddy as he tries to put out a blazing building. According to the cover of the instruction book our hero Freddy looks like a hotdog sausage wearing boots, and with a funnel for a

nose. Through this funnel Freddy squirts water to extinguish a normal orange window fire but six to put out a purple fire that chases and tries to corner him. Freddy must also dodge flame particles or he will lose a life. The same fate awaits him should he fail to catch a cat as it tries to jump to safety.

The games are controlled by joysticks, either plugged into joystick ports or built into the SV-318. The cursor keys of the SV-328 can be used but this makes the games even harder than they already are.

The tutorial tape is billed as an introduction to programming in Basic and consists of a tape and a booklet. The idea is that the user can read through the booklet while working through examples on the tape. The examples given are interesting as is the explanatory text; however, it is dogged with errors. These are particularly bad since the package is designed for the beginner who will be confused by the mistakes. For example, having explained the difference between the Commands SCREEN 1 and SCREEN 2 the text refers to SCREEN + which is obviously wrong to all but a beginner.

Benchmarks

BM1	2.3
BM2	5.7
BM3	18.2
BM4	20.0
BM5	20.9
BM6	32.8
BM7	45.1
BM8	235.7

All timings in seconds. For a listing of the Benchmark programs see 'Direct Access'

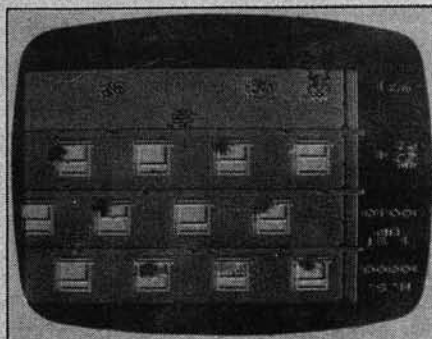

Crossforce

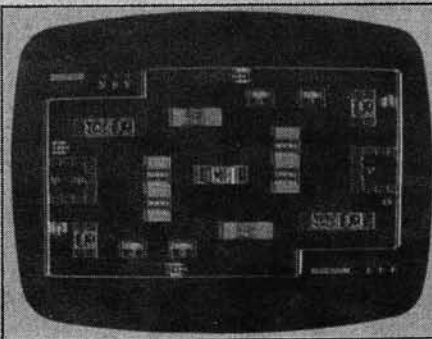

Armour Assault

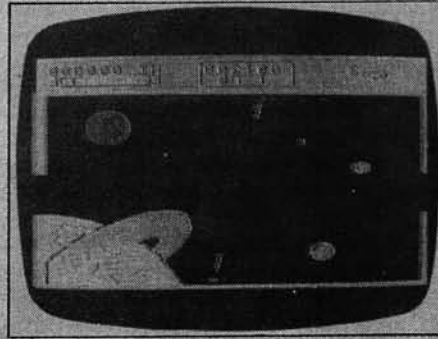

Frantic Freddy

The Perfect series of accounting software is available for the Spectravideo running under CP/M. The entire range is priced at \$799 but individual packages can be purchased. There is also a range of games etc. from Coleco which can be used on the Spectravideo with a Coleco adaptor priced at \$119.

Documentation

At first sight the documentation for the Spectravideo seems plentiful and adequate. In fact there seems to be too much of it — even the RAM packs come complete with their own user manuals.

The manual which accompanies the computer itself is a 3-holed ring binder containing a loose leaf manual and a quick reference booklet. It is pleasantly organised, complete with separator cards between chapters which allow easy access to the information. Unfortunately the manual wants to keep the machine's secrets safe from the prying user which it does by ploys such as example programs that don't work, directions to tables that don't exist and, as mentioned earlier, error messages for program structures that aren't supported.

Small chapters may make the manual easy to read but they are inadequate for teaching Basic. Eighteen pages is hardly enough to cover all of the Spectravideo's excellent sound and graphic capabilities.

By far the best manual included in the review package was the CP/M manual

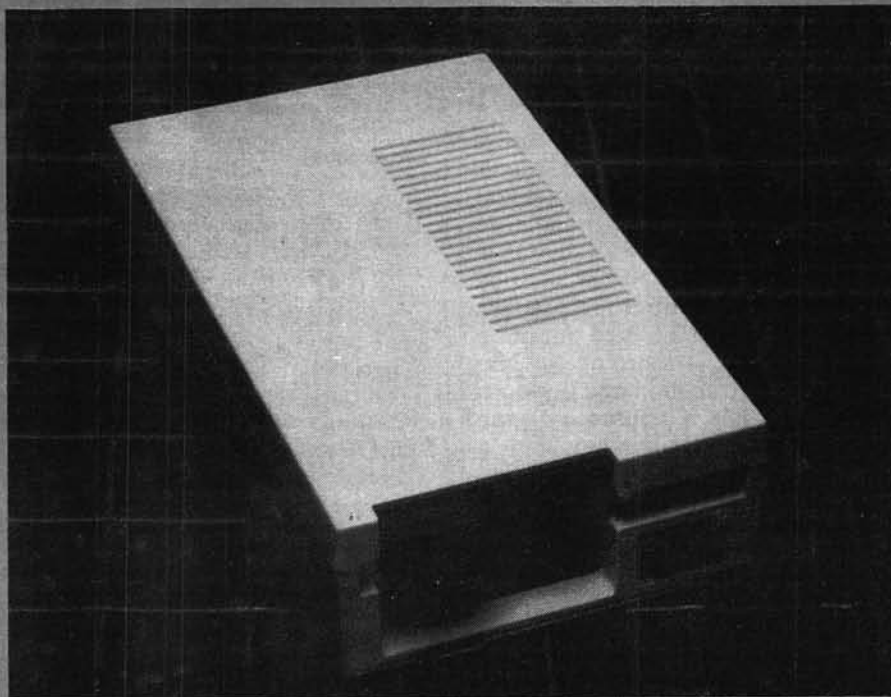

The disk drive uses standard 5 1/4 in single-sided, double density disks

which was mostly written by Digital Research. The section referring to features converted or specially written for the Spectravideo is concise and easy to understand. The more advanced features of CP/M will no doubt remain a mystery to all but the most determined user since the relevant sections of the manuals are daunting to the beginner.

Conclusions

Since the Spectravideo is the first MSX computer to reach Australia, my assessment of the machine is at two levels: as a machine in its own right and as the pioneering MSX micro.

The Spectravideo is priced to be in direct competition with the Commodore 64. It costs too much to be a serious

MSX — What is it?

The MSX system was proposed by Microsoft in Japan in an attempt to bring the standardisation of the record industry to the computer market. Such a system of standardisation is being welcomed by manufacturers, software houses and shops since they will all benefit from it.

Manufacturers of hardware, particularly of add on peripherals, will be able to produce goods for more than one machine at a time resulting in massive savings on research and production costs. Similar savings will be enjoyed by software houses with the additional benefit of a longer shelf life for their programs, since it is less likely that the machine for which they write will be superseded.

Invariably shops have serious shelf space problems since each computer needs a separate software display. MSX will solve this by requiring only one display for all machines.

MSX plans to achieve this standardisation by having at the centre of all computers Microsoft Extended Basic

running in a machine using a Z80 processor and featuring 16 colours and three sound channels. Since they will all have this standard format the software they use will be available for other MSX machines.

There are at present fifteen companies supporting MSX with Spectravideo being the only non-Japanese member. A full list of these is given below: it reads like a directory of Japanese electrical companies.

MSX is open to any company which wishes to join the scheme and is prepared to pay the admission fee. This may become an attractive package to companies thinking about entering the computer market since the computer design, particularly Basic, has been done for them.

This may be good for such companies but is it good for the computer market? Such standardising may seriously restrict developments and stagnate the industry as a consequence. Microsoft claims, however, that this will not happen since MSX is a very loose system allowing room for development. But the question is: Will

these developments be compatible with other MSX machines? I think not. I have seen literature written in Japanese claiming that the Sanyo MSX machine will be able to grab and store television pictures but the software required to run this probably won't work on a Spectravideo.

One final thought on MSX is: If there are many machines using the same software then software copying might become an even bigger problem than it is already. This is because copying will be possible where it is now impossible due to machine incompatibility.

Companies supporting MSX

Canon	NEC
Fujitsu	Sony
General	Pioneer
Hitachi	Sanyo
JVC	Spectravideo
Kyocera	Toshiba
Matsushita	Yamaha
Mitsubishi	

threat to the cheaper VIC-20 and VZ-200 end of the market. For the money it offers good sound and graphic capabilities. In fact these facilities are more often found in an advanced Basic cartridge costing up to \$60.

The difference between the cost of the SV-318 and the SV-328 is negligible when you consider the advantages of the bigger model. The combination of a full-size keyboard and 80k of memory will be irresistible to most people.

The Spectravideo is an incredibly easy machine to write programs for as it seems to be designed for programmers. Indeed it is to this area of the market that it will particularly appeal. The consumer games players will no doubt wait until there is a lot more software available for it. This will improve with the arrival of more MSX machines.

As an advert for MSX the Spectravideo is ideal but the system itself may encounter one or two problems which I shall outline below.

I have reservations about the scope for future developments should MSX become the standard. And will such developments supersede the existing generation of MSX making it redundant and incompatible, so defeating the whole principle behind MSX?

To become accepted as the standard throughout the world, MSX will have to extend beyond one non-Japanese company and include such companies as Commodore, Sinclair and, of course, IBM. This is highly unlikely since each of these companies is trying to make its own dialect of Basic the industry standard.

Clearly, MSX will not become the only system for home computers and I

envisage a situation similar to the video recorder market where a couple of different systems compete for supremacy.

To summarise: MSX represents a road to the future but it won't be the only one.

Prices (including sales tax)

Spectravideo 318 including power supply leads, manuals and cassette unit	\$399
Spectravideo 328 (not including cassette unit)	\$599
Super Expander	\$250
Disk drive controller and CP/M 2.2 and MSX Disk Basic	\$250
5¼ inch floppy disk drive (Expander, controller and disk drive may be purchased together for \$900)	\$550
Cassette unit	\$99
16k RAM cartridge	\$99
64k RAM cartridge	\$199
Graphics tablet	\$199
Coleco adaptor	\$119
Spectravideo printer	\$549

Technical specifications

Processor	Z80 running at 3.6 MHz
Memory	32k ROM SV-318 — 32k RAM SV-328 — 80k RAM
Keyboard	SV-318 — 71 rubber keys, built-in joystick SV-328 — 86 key full-size keyboard
Display	40 x 24, high resolution 192 x 256 pixels, 16 colours
Sound	3 channel sound via television speaker
Operating systems	MSX Basic, MSX-DOS, CP/M 2.2

WE ARE THE COMMODORE EXPERTS

HIGH TECHNOLOGY

Victoria's No. 1
Commodore Computer dealer

- ★ Victoria's largest range of Commodore programs and accessories
- ★ Victoria's only Commodore Authorised Service Centre
- ★ Victoria's only FREE regular Commodore Newsletter
- ★ Victoria's only Commodore telephone database
- ★ Victoria's oldest Commodore dealer

SOFTWARE

Hundreds of programs from

- ★ Abacus ★ Acme
- ★ Commodore ★ HES
- ★ Rabbit ★ Ozisoft
- ★ Llamasoft ★ Romik
- ★ Bubble Bus
- ★ Imagineering
- ★ And many more

**DEALER
ENQUIRIES INVITED
ON 596 7130**

SERVICE

Our new larger facilities with the latest equipment and U.S. trained technicians allow us to now offer fast and efficient repairs to all your Commodore equipment.

**We are Victoria's
ONLY Authorised
Service Centre.**

STOP PRESS
SIMON'S BASIC INTRO TO
BASIC PART 2 64 MON
64 SUPER EXPANDER
NOW AVAILABLE

COURSES

Our new training facility offers the right course for your needs.

- ★ Intro to Computers
- ★ BASIC Programming
- ★ Assembly Language
- ★ Business Applications

**MAIL ORDERS WELCOME
CALL OR WRITE FOR
FREE CATALOG**

MAIL ORDER DEPT: P.O. Box 3, BRIGHTON NTH 3186

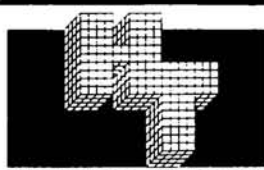

HIGH TECHNOLOGY

**HIGH TECHNOLOGY COMPUTER
SYSTEMS PTY. LTD.**

290 Bay Street, Brighton. 3186 Phone: 596 7130
87 Swan Street, Richmond. 3121 Ph.: 429 1966



STAR WORDS

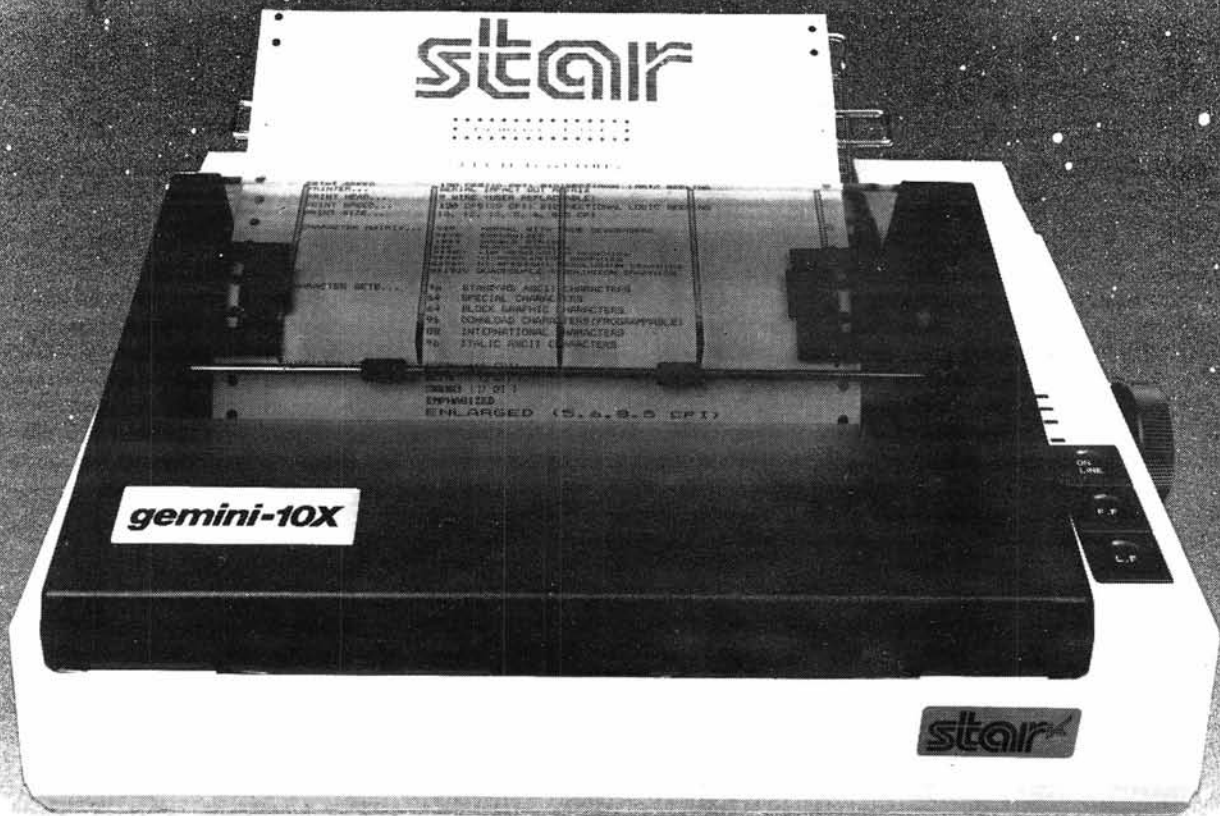

WHICH PRINTER TALKS TO ANY COMPUTER IN THE GALAXY AND COSTS AROUND 30% LESS THAN IT'S COMPETITORS?

Who else but STAR?

Character for character, the new STAR GEMINI family is the best value on the planet. A snappy 120 cps is yours for only \$449* (10 inch paper) or \$795* (15 inch paper).

And the GEMINI speaks all languages, be it Apple, IBM, NEC, T.I., Commodore . . .

Just see your nearest computer retailer for a demonstration of the Gemini's many features — all included as standard. You'll be amazed at our paper feed system that includes friction platen and fully adjustable tractor feed. Or how about the variety of type styles and graphics — printable in the same line?

*Please add sales tax where applicable.



The Printer Range That's Taking The World By Storm

Distributed by:



Case Communication Systems Ltd.

1-3 Rodborough Road
Frenchs Forest NSW 2086

Telephone (02) 452 5231
Telex AA72982

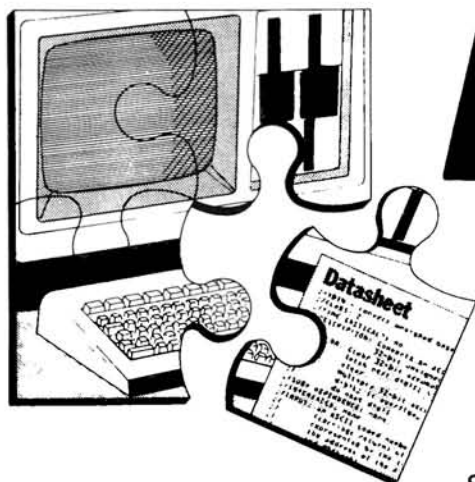

APC SUBSET

Alan Tootill and David Barrow present more useful assembler language subroutines. This is your chance to build a library of general-purpose routines, documented to the standard we have developed together in this series. You can contribute a Datasheet, improve or develop one already printed or translate the implementation of a good idea from one processor to another. APC will pay for those contributions that achieve Datasheet status. Contributions (for any of the popular processors) should be sent to SUB SET, 77 Glenhuntly Road, Elwood, Vic 3184.

Z80 block relocation

Several of you liked R Cath's 6502 block relocation routine RRL (misprinted as 6802 Block relocation, November '83) well enough to implement it for other processors. First, a couple of errors. LDA M9 should be

inserted at the 17th. instruction. The 41st. instruction should have been BBCRRL3. We apologise to the BBC.

For the Z80, we like this effort from Mark Wenham. His ROLR moves a block to either a lower or higher memory address using the Z80 block move instructions. One of its best features is its simple, unambiguous input require-

DATASHEET

```

;= ROLR—Block relocation.
;/CLASS: 2 (Could be made CLASS 1 by preserving the A
           register and flags, since they are not needed to
           convey information to or from the routine.)
;/ TIMECRITICAL?: No
;/ DESCRIPTION: Rotates a block of memory up or down
           memory.
;/ ACTION: Not given
;/ SUBDEPENDENCE: None
;/ INTERFACES: None
;/ INPUT: BC = address of first byte of block to be moved
;/         HL = address of last byte of block to be moved
;/         DE = address block to be moved to. (HL = BC
           is OK)
;/ OUTPUT: The block is rotated.
;/ REGs USED: AF, BC, DE, HL
;/ STACK USE: 6
;/ LENGTH: 68
;/ PROCESSOR: Z80
ROLR: AND A ;clear carry A7
      SBC HL,DE ;compare last address of ED52
      ADD HL,DE ;block with destn. address 19
      JR C,UP ;if destination higher, jump 38 OE
DOWN: PUSH HL ;else save end of block E5
      SBC HL,BC ;get length of block ED42
      PUSH HL ;and save it E5
      ADD HL,BC ; 09
      SBC HL,DE ;get total bytes between ED52
      EX (SP),HL ;end of block & destination E3
      POP BC ;into BC C1
      POP DE ;DE = address of end of blk D1
      INC HL ;HL = length of blk to be 23
      SCF ;moved. Set 'down' flag 37
  
```

```

UP: JR MOVE ; 18 11
    AND A ;clear carry A7
    INC HL ; 23
    SBC HL,BC ;get length of block ED42
    PUSH HL ;save it E5
    EX DE,HL ;destination = destination + EB
    ADD HL,DE ;length of blk to be moved 19
    EX DE,HL ; EB
    ADD HL,BC ;HL = end of block 09
    EX DE,HL ;HL = destination EB
    SBC HL,BC ;get total no. of bytes ED42
    LD D,B ;between destn. & blk start 50
    LD E,C ;DE = start of block 59
    EX (SP),HL ;HL = length of block E3
    POP BC ;BC = total bytes + 1 C1
    DEC BC ; 0B
MOVE: DEC HL ;decrement counter 2B
      PUSH HL ;save counter E5
      PUSH DE ;save start or end of block D5
      PUSH BC ;save no. of bytes to be C5
      LD H,D ;moved 62
      LD L,E ; 6B
      LD A,(DE) ;get byte 1A
      JR C,LWR ;jump if 'down' flag set 38 05
      INC HL ;else move rest of block & 23
      LDIR ;bytes between block and ED BC
      JR INS ;destination down 18 03
LWR: DEC HL ;or move rest of blk & bytes 2B
      LDDR ;from blk & destination up ED B8
INS: LD (DE),A ;insert byte 12
     POP BC ; C1
     POP DE ; D1
     POP HL ; E1
     PUSH AF ;save flags F5
     LD A,H ;test counter 7C
     OR L ; B5
     JR Z,END ; 28 03
     POP AF ;restore flags F1
     JR MOVE ;and continue 18 E3
END: POP AF ;restore stack F1
     RET ;and return C9
  
```

ments; the address of the first byte to be moved, the address of the last byte to be moved and the address to which the block is to be moved. Where the block is moved to a higher memory

address, memory below the destination is moved down to make way for it and where the block is moved to a lower memory address, memory above the destination is moved up.

More moving data

Like the first, the following two Datasheets this month deal with the problems of moving blocks of data — or programs — around in memory. BLKMOV from Martin Ford is an intelligent

block transfer routine for the 6502 to ensure that the transferred data will not overwrite the source data. BLKEXG is a 6809 version of RRL from Martin Chadwick. Martin wonders how many other 6809 users, outraged by the length of RRL, have written. None yet.

DATASHEET

- = BLKMOV — Intelligent data block move.
- ✓ CLASS: 2 (page zero altered)
- ✓ TIME CRITICAL?: No
- ✓ DESCRIPTION: Overwrite-proof data block transfer
- ✓ ACTION: If destination = source then end Else if destination > source then transfer from last byte downwards Else transfer from first byte upwards
- ✓ SUBDEPENDENCE: None
- ✓ INTERFACES: Source and destination RAM.
- ✓ INPUT: M0,1 = address of 1st byte of source block
M2,3 = address of 1st byte of destination
M4,5 = byte length of source block
- ✓ OUTPUT: Block transferred. M0—M5 corrupted
- ✓ REGS USED: M0—M5
- ✓ STACK USE: 4
- ✓ LENGTH: 112
- ✓ PROCESSOR: 6502

BLKMOV PHP	;save registers	08
PHA	:	48
TXA	:	8A
PHA	:	48
TYA	:	98
PHA	:	48
LDY #0	;zero index initially	A000
CLD	;ensure binary arithmetic	D8
LDX M4	;byte count lo-byte into X	A6ZZ
SEC	;test relative positions of source	38
LDA M0	;and destination, saving result	A5ZZ
SBC M2	;lo-byte for equality check	E5ZZ
STA M4	;if no carry from result, then	85ZZ
LDA M1	;destination higher than source	A5ZZ
SBC M3	;and transfer to be from end byte	E5ZZ
BCC BKWD	;downwards	901D
ORA M4	;if dest. = source then no move	05ZZ
BEQ BRET	;necessary so exit	F04D
INC M5	;dest. < source so move from lowest	E6ZZ
TXA	;byte upwards. Hi-byte count is dec'd	8A
BEQ TST2	;separately, so INC it first	F00E
LP1: LDA (M0),Y	;if lo-byte count in X not zero then	B1ZZ
STA (M2),Y	;move data byte and index next	91ZZ
INY	;skipping to count decrement if index	C8
BNE TST1	;not zero. Else 256 bytes moved so	D004
INC M1	;inc source and dest. base pointers	E6ZZ
INC M3	;to next 256-byte block	E6ZZ
TST1: DEX	;loop for no. of bytes in count	CA
BNE LP1	;lo-byte	D0F2
TST2: DEC M5	;loop for no. of 256-bytes in	C6ZZ
BNE LP1	;count hi-byte	D0 EE
BEQ BRET	;finished	F034
BKWD: TXA	;starting at last byte so change	8A
ADC M0	;source and dest. base pointers to	65ZZ
STA M0	;address last byte — 255 by adding	85ZZ
LDA M5	;data block byte length and	A5ZZ
ADC M1	;subtracting 256. Then dec Y so	65ZZ
STA M1	;Y = 255 initially and indexes	85ZZ
TXA	;end byte	8A
CLC	:	18

ADC M2	:	65ZZ
STA M2	:	85ZZ
LDA M5	:	A5ZZ
ADC M3	:	65ZZ
STA M3	:	85ZZ
DEC M1	:	C6ZZ
DEC M3	:	C6ZZ
DEY	:	88
INC M5	;inc count hi-byte for extra dec later	E6ZZ
TXA	;initial test of count lo-byte	8A
BEQ TST4	;if zero dec count hi-byte	F00F
LP2: LDA (M0),Y	;move data byte and index next	B1ZZ
STA (M2),Y	;skipping to count decrement if	91ZZ
TYA	;dec'd index not gone below zero	98
BNE TST3	;else 256 bytes moved s decrement	D004
DEC M1	;hi-bytes of base pointers to give	C6ZZ
DEC M3	;addresses of next 256-byte block	C6ZZ
TST3: DEY	:	88
DEX	;loop for no. of bytes in count	CA
BNE LP2	;lo-byte.	D0F1
TST4: DEC M5	;loop for no. of 256-bytes in	C6ZZ
BNE LP2	;count hi-byte	D0 ED
BRET: PLA	;restore registers	68
TAY	:	A8
PLA	:	68
TAX	:	AA
PLA	:	68
PLP	:	28
RTS	;and return	60

DATASHEET

- = BLKEXG — Data block exchange (= Rotate Right Long)
- ✓ CLASS: 1
- ✓ TIME CRITICAL?: No
- ✓ DESCRIPTION: Exchanges positions in RAM of two contiguous blocks of data.
- ✓ ACTION: Exit immediately if 2nd block at lower address than 1st block.
For each byte in 2nd block
Pick up byte
Move 1st block up by one byte
Put byte below 1st block
- ✓ SUBDEPENDENCE: None
- ✓ INTERFACES: 1st & 2nd blocks in contiguous RAM
- ✓ INPUT: X = address of 1st byte of 1st block
D = address of 1st byte of 2nd block
Y = address of byte following 2nd block
- ✓ OUTPUT: Carry set: input error — no action
Carry reset: order of 1st & 2nd blocks exchanged
D = new 1st block, X = new 2nd block
- ✓ REGS USED: DXYCC
- ✓ STACK USE: 10
- ✓ LENGTH: 34
- ✓ PROCESSOR: 6809

BLKEXG: PSHSD,X,Y	;save registers	34 36
SUBD2,S	;calculate length of 1st block	A3 62
BCC MV3	;and go okay if 1st block lower	24 10
PULSD,X,Y,PC	;else exit, Cy set, error.	35 B6
MV1: LDB X	;pick up next 2nd block byte	E6 84
MV2: LDA -X	;shift 1st block up by one byte	A6 82
STA 1,X	;work down with endtest	A7 01
CMPX 2,S	;on stacked ad. of 1st block	AC 62
BNE MV2	;start byte. Then put 2nd block	26 F8
STB X+	;byte, inc 1st block start	E7 80
PULS D,Y	;addr. Rest. length, discard old	35 26
MV3: PSHS D,X	;start ad.) Save length and 1st	34 16
LEAX D,X	;block address. Get next ad.	30 8B
CMPX 8,S	;2nd block byte and loop	AC 68
BNE MV1	;if not at end of 2nd block	26 EA
PULS D,X,Y	;else end. Cy reset, tidying up	35 36
PULS D,Y,PC	;stack and rest. values.	35 A6

Blitz on New York

Tony Harrington reports on the New York 4th World Microcomputer Chess Championships.

Micro Chess — a guide for beginners

Micro Chess is an occasional column which covers all the news and events in the busy world of computer chess. With new chess programs and new chess computers appearing all the time, we evaluate their strengths and weaknesses as they become available. We shall be presenting profiles of programmers, both amateurs and professionals, which will cover their methods and their interest in chess programming, and we shall be talking to suppliers and looking at their plans.

Computer Chess affects computer

enthusiasts in two different ways. For some, the fact that they can now play chess against either their home computer or a dedicated chess computer has opened up the delights of the game. For others, the real interest is not so much in playing chess as in trying to build a chess program. Micro Chess aims to meet the interests of both.

Chess is a game that can be as exciting for the beginner as it is for the grand master. So if you haven't played before, get yourself a good introduction to the game — there are dozens in the bookshops — and get to it. Remember, with computer chess a game can be as fast or as slow as you want.

The 4th World Computer Chess Championships is held every three years under the joint auspices of the ACM, the main US professional body for data processing personnel, and the ICCA.

The ACM puts up the cash for the competition and helps entrants to pay for hotel expenses, and so on. The ICCA sanctions the results of the competition. This, by the way, is not a homely little affair for micros. It is an open event, where supercomputers like the mighty Cray make their appearance. This doesn't stop the micros from entering, but it doesn't do a great deal for their winning chances.

This time the event was held at New York's luxurious Sheraton Hotel. By no coincidence at all, the ACM held its own three-yearly conference at the same time and place, so the tournament acted as a side-show for the ACM delegates, many of whom drifted into the playing area to watch the games.

Play was from seven in the evening till midnight, with the resident programs (that is, those who were not participating by land-line) going on till two in the morning on occasions. If this leads eventually to some of the watching DP specialists taking up the mysteries of mini-max search theory and producing their own fledgling chess programs, so much the better.

We'll be following the competition with the assistance of commentary from Don Beal author of BCP which competed at the Championships.

Don Beal has been to all four of these tournaments, like other participants he was impressed by the improvements made in chess programming in the three years since the last World Championships.

It was clear from the play that there had been definite steady progress. What I noticed particularly was that the best of the microcomputer based entries did better this time than ever before. Three years ago it would have been fair to say that the micros were struggling to come bottom. Now they

Results table for the 4th World Chess Championships

(The number on the left of each column indicates the opponent and the colour of the pieces; that is, Cray Blitz was black against Fidelity X in round 2.)

Program	Round 1	Round 2	Round 3	Round 4	Round 5	Total Pos
1 Cray Blitz	W14 ₁	B10 ₂	W6 ₃	B5 _{3.5}	B7 _{4.5}	1st
2 Awit	W15 ₁	W6 ₁	B12 ₂	W19 ₃	B13 ₄	2-3rd
3 Bebe	B11 ₀	W20 ₁	W9 ₂	B10 ₃	B5 ₄	2-3rd
4 Chaos	B9 _{0.5}	W21 _{1.5}	B19 _{2.5}	W7 _{2.5}	W6 _{3.5}	4-5th
5 Nuchess	W20 ₁	B11 ₂	W7 ₃	W1 _{3.5}	B3 _{3.5}	4-5th
6 Advance 3.0	W22 ₁	B2 ₂	B1 ₂	W8 ₃	B4 ₃	6-9th
7 Belle	B13 ₁	W8 ₂	B5 ₂	B4 ₃	W1 ₃	6-9th
8 Mephisto X	W18 ₁	B7 ₁	W16 ₂	B6 ₂	W15 ₃	6-9th
9 Schach 2.7	W4 _{0.5}	W12 _{1.5}	B3 _{1.5}	B11 _{2.5}	W10 ₃	6-9th
10 Fidelity X	B16 ₁	W1 ₁	B18 ₂	W3 ₂	B9 _{2.5}	10-13th
11 Merlin	W3 ₁	W5 ₁	B13 _{1.5}	W9 _{1.5}	B18 _{2.5}	10-13th
12 Novag X	W17 _{0.5}	B12 _{0.5}	W2 _{0.5}	B21 _{1.5}	B14 _{2.5}	10-13th
13 Phoenix	W7 ₀	B22 ₁	W11 _{1.5}	B17 _{2.5}	W2 _{3.5}	10-13th
14 BCP	B1 ₀	W18 ₀	B22 ₁	B16 ₂	W12 ₂	14-16th
15 Ostrich	B2 ₀	W18 ₀	B20 ₁	W18 ₂	B8 ₂	14-16th
16 Pion	W10 ₀	B15 ₁	B8 ₁	W14 ₁	W17 ₂	14-16th
17 Bobby X	B12 _{0.5}	B19 _{0.5}	W21 _{1.5}	W13 _{1.5}	B16 _{1.5}	17-21st
18 Conchess	B8 ₀	B14 ₁	W10 ₁	B15 ₁	W20 _{1.5}	17-21st
19 Patsoc 2.0	B21 _{0.5}	W17 _{1.5}	W4 _{1.5}	B21 _{1.5}	W11 _{1.5}	17-21st
20 Philidor	B5 ₀	B3 ₀	W15 ₀	W22 ₁	B18 _{1.5}	17-21st
21 Shy	W19 _{0.5}	B4 _{0.5}	B17 _{0.5}	W12 _{0.5}	B22 _{1.5}	17-21st
22 Stinks X	B6 ₀	W13 ₀	W14 ₀	B20 ₀	W21 ₀	22nd

were holding their own in the middle of the field,' Beal commented.

He reckons that the improvement in over-the-board play has a lot more to do with improved programming than it has with added speed and processing power. Though when it comes to a program like the Cray Blitz, which ran not just on any ordinary old Cray, but on a special experimental model consisting of three linked Crays, the relative effects of hardware and software became a little difficult to sort out.

The twin surprises of the competition were both associated with Ken Thompson's Belle. The American Chess Federation decided to acknowledge Thompson's contribution to computer chess. Belle has an outstanding record. Before this tournament, Belle had never, in any of its many versions, lost a game to another computer. It had also come joint second with several players at the 1982 US Speed Chess Championships. So the Federation awarded Belle a US international master title at a little ceremony half way through the tournament. Belle promptly responded by losing its first two games ever, one to Nuchess and one to Cray Blitz.

The West German chess journalist, Friedric Friedel, reckons that both losses were 'statistical'. Belle simply found itself in what happened to be two losing positions. He and other Belle watchers still believe Belle to be the strongest program. In the game against Nuchess, for example, it found the winning line for Nuchess, but just happened to be playing with the losing pieces. Chess is a strong game in which World Champions have found themselves with lost positions on occasion inside 20 moves.

For those of you who might be scanning the results table for clues to the strength of the commercial chess machines that will appear later this year, remember that a five-round Swiss tournament with 22 entries produces some funny results in the middle orders. A better guide to strength than overall positions would be to look at a particular machine's opponents. A full point taken off Sfinks X, for example, which came last with zero points, is not quite the same thing as a full point taken off Belle!

Games Section

Inevitably attention has to focus on the performance of Cray Blitz. It had an awesome amount of processing power behind it, probably more than any computer chess program has ever enjoyed in any competition anywhere. Tactically, this gave it an overwhelming superiority. But as a careful scrutiny of its games demonstrates, despite its ability to play the most hair-raising

tactical positions, Cray Blitz, with all its hardware, is capable of playing the odd pawnless move. This might sound like a churlish comment, but look at the way it plays the late middle game against Beal's BCP.

The table shown, reproduced from the official tournament bulletin, gives the full list of participants in order of their final placings — my thanks to the organisers.

The second game this month, annotated by David Levy, is the exciting final round clash between Cray Blitz and Belle, in which Belle lost for only the second time in its eventful history. The first game described here shows Cray Blitz's first round game against Don Beal's BCP.

Beal was unfortunate to find his program drawn against the mighty Cray right from the start. With so large a field, there was a reasonable chance that he might have avoided playing it altogether. His troubles were multiplied by the fact that what looks like a carefully prepared book opening, the Nimzowitsch variation 2... Nf6 in the Sicilian Defence, found the Cray's huge openings repertoire fully prepared.

The point of pre-programming the Nimzowitsch variation as black is to avoid the main lines of the Sicilian, where Beal would have expected one of the larger programs to have a comprehensive openings library with many prepared tricks in store. Against an opponent with less memory than the Cray, Beal might well have been successful. Here, however, he found an opponent who could play what was supposed to be an unusual line effortlessly from its library.

1 e4 c5 2 Nf3 Nf6 3 e5 Nd5 4 Nc3 e6 5 Nxd5 exd5 6 d4 Nc6 7 dxc5 Bxc5 8 Qxd5 Qb6

So far everything is according to book. This is the natural attacking move. Black has given up a pawn for active piece play and now threatens to win it back immediately by taking the pawn on f2 with check. In one of the book lines, white counters this threat by duplicating it: he plays 9 Bc4 which puts the Black King's Bishop pawn under fire. Black takes the pawn on f2 and castles once white plays Ke2, removing the threat on his own pawn on f7. White then has active piece play and a very complex and unclear position results. Cray Blitz rejected this line.

Computers do not like giving up pawns when no clear measurable advantage results. Making predictions about the complex evaluation functions of programs like Cray Blitz, Belle and Nuchess is a thankless task. But at least as far as the more 'down market' computer programs are concerned, their scoring functions rate a pawn win

as a solid plus and they want to see some tangible gain if they are going to give up this plus. BCP has got this far because it is 'in book'. The Cray shows a touch of class here by varying from book in a line that gives the pawn back without immediate material advantage.

Cray Blitz retreats the queen to cover f2:

9 Qd2 0-0 10 Bc4 Re8

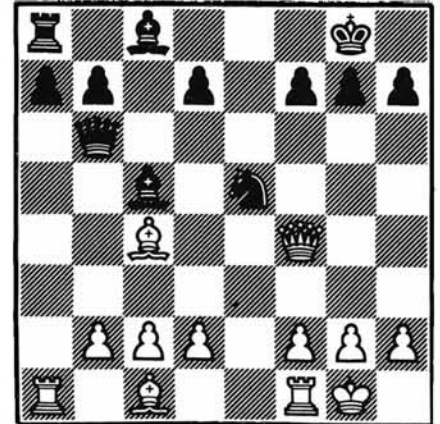

The fun begins. Black has the white e pawn in its sights, but material equality is not everything. To be fair to Beal's BCP, it is not immediately clear what black's plan should be other than to win the e pawn. His pieces are boxed over on the queen side and white has good chances for a king side attack.

110-0... a move which invites Nxe5. I was curious to see if one of the better commercial dedicated chess computers, like the Novag Constellation, would find and play such a move. On level 6 it immediately looked at and rejected 0-0 and opted, after around two minutes of analysis, for the vastly inferior 11 Qe2 to protect the pawn. Nxe5 12 Nxe5 Rxe5 13 Qf4!

A natural and obvious move. After black's thirteenth move, Constellation found 13 Qf4 immediately in my test run. But seeing one move ahead is never a great difficulty. The critical test was to spot this position as advantageous back on move 11. White puts both the f7 pawn and the rook on e5 under threat. Black could now play 13... Re7, but his blocked white bishop will slow him down badly. In reply to this white could simply play 14 Bd2 (ignoring the threat 14... Qxb2) and 15 Rael with a winning attack. In the event, Black settled for wrecking his position with 13... Qf6. (Constellation, in the same position, opted for 13... Re7, and, playing both sides of the position, quickly discovered the win for white.)

13... Qf6 14 Qxf6 gxf6

At this point I would rather be white, but there may be ways for black to make

a game of it. Cray Blitz finds a very strong continuation.

15 Kh1 d5 16 f4 Rh5

This is the sort of move that most human chess players would quite sensibly reject out of hand. The rook has no safe retreat squares once it gets trapped on this flank and the two white bishops should be able to force a favourable exchange. BCP cannot see all the way to the inevitable capture, so the evaluation function gives priority to keeping the rook 'active'. It's one of those positions that really tests the programmer.

18 Bb3 d4 19 g3 Rh3 20 f5 Kg7 21 Kg2 Rh6 22 Bxh6+ Kxh6

And so the exchange is forced. From here Cray Blitz goes through a fairly mediocre patch before finding the win, which, from this position, was simply a technical exercise.

23 Bd5 Kg7 24 Rad1 a5 25 Kh1 Ra6 26 Be4 b5 27 Rfe1 Bd7 28 Rd2 Bc6 29 Bxc6 Rxc6 30 Re8 Bb6 31 Rb8 b4 32 Rb7 Kf8 33 Re2 Bc7 34 g4 Rc5 35 Ra7 Bb6 36 Ra6 Rc6 37 Rd2 Rd6 38 Rd3 Kg7 39 c3 Kg8 40 a4 Kg7 41 cxb4 axb4 42 a5 Bc5 43 Rxd6 Bxd6 44 Rxd4 Bc5 45 Rd5 Be3 46 Rd3 Bc5 47 Rd7 Be3 48 a6 h5 49 gxh5 Kf8 50 Rd3 Bc5 51 Rg3 Ke8 52 h6 Bd6 53 a7 Ke7 54 Rd3 Bc7 55 a8=Q Bd6 56 h7 b3 57 Qb7+ ke8 58 h8=Q+ Bf8 59 Qe4 checkmate. 1-0

Belle vs Cray Blitz

White: Belle. Black: Cray Blitz. World Computer Championship, New York 1983. Sicilian Defence. Notes by David Levy.

This was the game that everyone had been waiting for. If Belle had won the game, there would have been a 3-way tie for first place, with Belle winning on tie-break.

1 e2-e4 c7-c5
2 c2-c3

(A move which was rarely seen a decade ago, but which is now rather popular in human tournaments and in computer events. If Black does nothing, his opponent will build a strong pawn centre with d2-d4. The only two moves which come into serious consideration are 2... Ng8-f6 and 2... d7-d5.)

2 ... d7-d5
3 e4xd5 Qd8xd5
4 Ng1-f3

(The move order 4 d2-d4 e7-e6 5 Ng1-f3 is somewhat more usual.)

4 ... e7-e6
5 d2-d4 Ng8-f6
6 Bf1-d3 Nb8-c6

(Both 6... c5xd4 7 c3xd4 Nb8-c6, and 6... Be7, are more often seen.)

7 0-0 Bf8-e7
8 Bc1-e3 0-0
9 d4xc5 Rf8-d8
10 Nf3-d4?!

(This move allows Black to retain most of the pressure in the d-file. White should have been content to trade queens and maintain a very small edge by 10 Bd3-e2 Be7xc5 11 Qd1xd5 Rd8xd5 12 Be3xc5 Rd5xc5 13 Nb1-d2.)

10 ... Be7xc5
11 c3-c4?!

(Parting with control of two important squares, b4 and d4. White should probably play 11 Nd4xc6, and if 11... Qd5xc6 12 Qd1-e2; or if 11... b7xc6 12 Be3xc5 Qd5xc5 13 Qd1-e2, with roughly equal chances in each case.)

11 ... Qd5-d6
12 Nd4xc6 b7xc6
13 Be3xc5 Qd6xd3
14 Qd1-a4?

(After this move, Black's advantage is clear. The correct plan was to trade queens: 14 Qd1xd3 Rd8xd3 15 Nb1-c3, and if 15... Nf6-d7 16 Nc3-a4.)

14 ... Nf6-e4
15 Bc5-b6

(Naturally not 15 Bc5xa7?? Rd8-d7, winning the bishop. But better than the artificial text move would have been simply 15 Bc5-e3.)

15 ... Rd8-d7
16 Bb6-a5 Bc8-b7
17 Nb1-c3 Ne4-c5
18 Qa4-b4 Qd3-d4
19 Ra1-d1 Nc5-d3
20 Qb4-a4 Qd4-g4

(Threatening 21... c6-c5!, opening the b7-g2 diagonal, as well as the more prosaic 21... Nd3xb2.)

21 c4-c5 Qg4-f5

(Now White must lose at least a pawn, but Belle makes the wrong decision and decides that rather than give up a pawn it will sacrifice its queen for rook and minor piece. This trade is materially equivalent to a pawn, but the queen is much more powerful in this type of position and White's bishop is left completely out of play. This type of error in judgement is what still makes it possible for the strongest humans to win against the strongest computer programs.)

22 b2-b4 Nd3-b2
23 Rd1xd7 Nb2xa4

24 Nc3xa4 Qf5-c2
25 Rd7xb7 Qc2xa4
26 Rf1-a1

(White has poorly coordinated forces, and can offer little resistance to the raging black queen.)

26 ... e6-e5
27 f2-f3 Qa4-c2
28 Rb7-c7 Qc2-d3

(Threatening 29... Qd3-d4+, forking king and rook.)

29 Ra1-f1 Qd3-d5
30 a2-a3 g7-g5
31 Rc7-e7 f7-f6
32 Re7-c7 h7-h5
33 h2-h3 Kg8-h8

(A typical computer move — when in doubt, put the king on a safer square!)

34 Kg1-h2 a7-a6
35 Rf1-e1 Ra8-e8
36 Re1-e4 f6-f5
37 Re4-e2 g5-g4!
38 h3xg4 f5xg4
39 f3xg4 h5xg4
40 Re2-f2 e5-e4
41 Rf2-f7 Qd5-e5+
42 g2-g3 e4-e3
43 Rf7-h7+ Kh8-g8
44 b4-b5

(Sacrificing a pawn in order to slow down the advance of the Black e-pawn, but it soon becomes clear that White must lose even more material.)

44 ... c6xb5
45 Ba5-e1 Qe5-b2+
46 Kh2-g1 Qb2-a1
47 Kg1-g2 Qa1-f6

(Not 47... Qa1xe1?? when White can draw by 48 Rc7-g7+ Kg8-f8 49 Rg7-f7+ Kf8-g8, etc.)

48 Kg2-h2 Re8-d8
49 Rh7-d7

(Black was threatening 49... Rd8-d1.)

49 ... Rd8-f8
50 Rd7-d6 Qf6-b2+
51 Kh2-g1 Qb2-b1
52 Kg1-h2 Qb1-c2+
53 Kh2-g1 Qc2-c5

Resigns

(There is no satisfactory defence to the threat of 54... Qf5-f1+ 55 Kg1-h2 Qf1-e2+ and 56... Rf8-f1 mate.)

(The king is dead, long live the king!)



'No thank you! I have no wish to be beaten three times by a flamin' recycled Datsun 1600.'

The age of reason

An intuitive programming language? Or one which acts on perception of bodily gestures? Surya travelled to Massachusetts to talk to Greg Gargarian at Atari's research lab, to find out about two of the company's current research projects.

Atari's research and development lab is situated on the eighth floor of the Five Cambridge Centre: an office block on the edge of the Massachusetts Institute of Technology complex. I'm not sure what impression of a research lab I had in my head, but it definitely didn't include being greeted by BJ — a small, friendly black dog who wanders around the lab in search of people willing to stop and talk to him.

My visit was punctuated by occasional messages over the PA system ('If anyone knows why the Sage machine has half its memory missing, please call 271'). The staff, I was told, varied between five and thirty in number. Most are in their early twenties and dressed in blue denim. A4-sized terminals are scattered throughout the offices, linked to one of the Lisp machines. A large board, situated outside the computer room, is used to connect the terminals via a mass of interconnecting RS232 cables.

About half of the lab's staff had come from the Logo lab at MIT, and the Logo connection is evident in the work being carried out at Atari. One of the projects at the lab is the development of a form of Logo with the working name QLogo ('Q' standing for 'Quasi-'). QLogo combines Logo and Smalltalk in a hybrid language which could become a user friendly alternative to Lisp.

Lisp, which stands for LISt Processing, is the mainstream artificial intelligence language. The language was originally developed for database and mailing list applications. Given a number of relationships, Lisp could then 'draw conclusions' about implied relationships. Let's take a simple example.

You have a database of customers, and want to arrange a selective mail-

shot. Having specified that all APC readers have good taste, and that readers of other magazines are suffering from a mild but curable affliction, you can then instruct your database to compose a mailing list of all those people who have good taste, and those who suffer from a mild but curable affliction. Providing that both qualities are exclusive (that is, reading APC is the only evidence of good taste), the list will comprise people who read both APC and any other micro magazine.

Smalltalk was designed to be addressed in something much closer to natural language than languages like Lisp. The language is oriented towards expert systems. These are computerised models of decision making, classifying and diagnostic processes. The idea is that an expert works out exactly how he will tackle a problem and then supplies the computer with a model of the decision making process. Non-experts can then interrogate the system as if it were the expert. Perhaps the most publicised use of an expert system is in the area of medical diagnostics. The system is set up to ask the patient a series of preliminary questions, each fresh question being determined or modified by the response to the previous one. The expert system is, of course, modelling the interview a doctor would have with a patient. It can then present the doctor with a summary of the exchange and perhaps a suggested diagnosis. The system is not intended to replace the doctor, but merely to save time prior to seeing the doctor.

QLogo

The basis of research into QLogo lies in the question: Can a programming

language be intuitive? In asking this question, Atari is taking a slightly different tack from the more traditional AI question: Can we create a programming language capable of reasoned deduction?

There are those who will dismiss the possibility of an intuitive programming language out of hand, in the same way that many will argue that there is no such thing as artificial intelligence — only the illusion of intelligence. The question is: Can we create a program-





ming language which succeeds in anticipating the goal of the user without step-by-step instructions?

What is the difference between a reasoning language and an intuitive one? Atari sees the difference in the intended user. Languages such as Lisp can be said to be reasoning in an as yet fairly crude sense, in that they are capable of deducing relationships which have not been explicitly stated. But Lisp, as anyone who has had even a passing encounter with the language

will know, has an extremely tedious syntax. Though dedicated Lisp hackers may not see what all the fuss is about, not everybody wants to spend six months learning a language. Five minutes with Lisp and most people will never want to see another bracket in their life.

Lisp and Logo both have a limited ability to model intelligence, but you have to learn complex syntax rules before you can make use of that ability. The user has to adjust to the models

required by the language, rather than the other way round. *Greg Gargarian, technical services manager of the lab:* 'Seymour Papert talks of Logo as a means of creating microworlds (computer-simulated environments). The problem is that it's difficult for a non-technical user to probe on conventional systems. They can't just play around and create something which almost works, and then try to debug it. They can produce something which generates friendly error messages, but

"Quality Circle" Diskettes

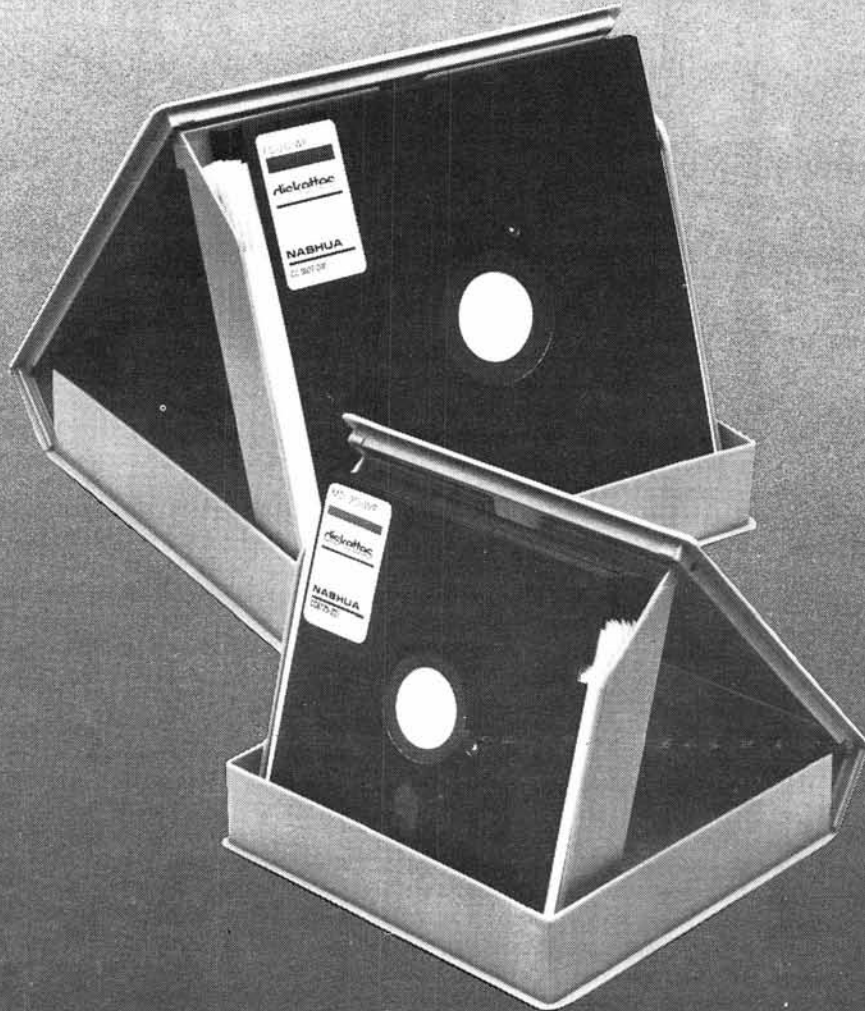

NASHUA

Computer Disc Division

Sydney: (02) 958 2044, Melbourne: (03) 428 0501,
Brisbane: (07) 369 4244, Adelaide: (08) 42 0021,
Perth: (09) 328 1888, Darwin: (089) 81 6204,
Auckland: 33193, Port Moresby: 21 2277

that's not quite the same thing! We're trying to design something that will enable people at least to get close to what they want, without having to know too much about programming.'

Microworlds was the name coined by Seymour Papert to describe computer-simulated environments, in which the user specifies the rules governing the environment and the computer organises the simulation according to those rules. Flight simulator programs can be thought of as a form of microworld. The computer is programmed to simulate a particular aircraft, and the simulator will act and react in ways consistent with the characteristics of that aircraft.

Seymour suggested that Logo is an ideal language in which to create microworlds. But Atari argues that, whatever Logo's merits, it still requires its users to spend a fair amount of time learning a programming language. As with any other language, Logo is fussy about syntax and will blindly do exactly what the programmer tells it to — even if to do so will only generate an error message or, worse, harm the program or data.

QLogo takes a different approach. 'Through it,' says Greg, 'Atari hopes to provide the means of designing more natural interactions.' Instead of requiring explicit step-by-step instructions, QLogo attempts to process more general or vague directions from the user. One of the ways in which it will assist the user in organising and expressing his needs will be through a Lisa-like windowing system.

Briefly, a windowing system presents the user with a number of different screens on which the tasks in hand are presented. Each part of the task to be done is given its own screen, and the user can switch between tasks by enlarging tiny windows to the corresponding screens. He can switch between a cash flow analysis, on a spreadsheet, draw figures from a database and write a report on a word-processor — switching backwards and forwards as required. This is a much easier and friendlier method than the traditional 'one thing at a time' approach, and gives the user far greater control over the work without requiring in-depth computing knowledge.

Full details of Lisa can be found in the August 1983 issue of APC.

Atari has in mind non-programmers, children particularly, using QLogo in a similar way to create microworlds. A physicist may want to create a microworld in order to test the practicality of a theory. A teacher might want to illustrate the way in which a frictionless universe would operate. A musician could compose a piece of music, and

then hear it played on different instruments, at different tempos, transposed up or down, in different styles, or with different rhythm backings. A child could grasp the meaning of a formula by having it displayed in graphical form and watching it change as different values are entered. A games designer may want to experiment with a particular environment before building a game around it . . .

Atari is particularly interested in using QLogo with music. The close relationship between music and mathematics is such that some mathematicians have described composition as a branch of applied mathematics. Greg Gargarian: 'We're talking about taking a piece of Bach, and using QLogo to play it in a ragtime style, for example. In education, there are lots of possibilities; to a child, music is probably the most significant form of mathematics.'

I was unable to see a demonstration of QLogo linked to a synthesiser, as the machine to be used for this purpose turned out to be the Sage of missing memory fame (the Lisp machines at the lab are all named after spices — Salt, Pepper, Thyme, Sage . . .). Everyone seemed at a loss to know how 256k of Symbolics RAM could disappear without trace, but whatever the explanation, the unceremoniously downgraded machine wasn't playing.

Without the front end, QLogo is

devices like touch sensitive screens in place of keyboards, so that the same physical device is used for both user input and direct feedback. I asked Greg Gargarian to explain the difference between Gesture and a conventional programming language.

'Other programming languages relate to people intellectually. Information is presented on a screen, users have to interpret it and then indicate their responses through the abstract medium of language. Gesture relates to the user both intellectually and physically; for example, we can use devices which give direct sensory feedback.

'We see the prime use of Gesture as an educational tool. Seymour Papert has used the analogy of the perfect ski slope, one on which a non-skier can begin at the top, and eventually reach the bottom a competent skier: no explicit tuition is necessary because the ski slope itself teaches implicitly. It's designed in such a way that the slope guides the novice through all the movements necessary to learn the skills involved in skiing. We're trying to explore Gesture in this sense.'

The idea of linked kinetic, auditory and visual feedback is not new. The full scale flight simulators used to train airline pilots are an obvious example. What is new is the idea of a complete programming environment, perhaps using QLogo, in which an unlimited

'What is new is the idea of a complete programming environment, perhaps using QLogo, in which an unlimited range of sensory microworlds can be created and used.'

something of a cross between Lisp and Logo in syntax, the Smalltalk influence being less visible. With a friendly front end, however, the language could make the power of an AI language accessible to non-programmers for the first time. It should be of great benefit to children, especially.

Gesture

A programming environment which responds not to keyboard input but to perception of physical movement sounds like a strange idea. Yet this concept is another of Atari's current research projects called Gesture.

I describe Gesture as a programming environment because that's the most accurate description. Programming language isn't right, since the user doesn't relate to Gesture through language. Perhaps a physical interface to microworlds is a more accurate, if more jargonistic, description. Gesture uses

range of sensory microworlds can be created and used. The possibilities both in the area of games and in more practical applications are tremendous. Imagine a Grand Prix racing game in which a steering wheel is geared to present a varying degree of resistance to a turn, the amount of resistance depending on the speed of the car. Think of the resistance of a real steering wheel if you were to attempt a sharp turn at 200mph.

Consider a piece of dangerous equipment like a lathe or drill. Imagine being able to simulate not only the visual and auditory reactions of the machine, but also being able to give kinetic feedback — the warning vibrations which may signify danger, and so on. Or take a more sophisticated form of the Grand Prix game, and turn it into a simulator for elementary driving lessons.

On a different tack, Gesture could be used as part of an image processing system. Images could be captured and

Get your hands on some extra time

Your personal computer could be handling its entire workload in a fraction of the time it now takes. All you need is the time saver — the remarkable Concurrent CP/M™ operating system from Digital Research.

Concurrent CP/M is the only personal computer operating system that lets you run up to four separate jobs simultaneously. You can start a single program just as you do now. But when you want to, just touch a key and you get a fresh screen to work with . . . while your original program continues to run. That means you don't have to kill time while your PC

runs payroll. Or quit your spreadsheet to answer questions about stock. And you can return to your first project whenever you're ready. Each of your four programs is only a keystroke away at all times.

With the new true window facility built into Concurrent CP/M, you can keep track of all of these, on screen, simply and easily.

Concurrent CP/M makes it so natural to work with your PC; you'll use it to do more work . . . with time to spare.

Get a personal demonstration of Concurrent CP/M with windows at your local computer dealer today.

Concurrent CP/M™ With Windows

The logo, tagline, Concurrent CP/M and CP/M Library are either trademarks or registered trademarks of Digital Research Inc. 1983 Digital Research

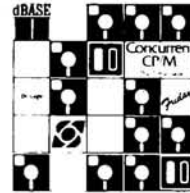

**arcom
pacific**
■ master distributor ■



IBM PC and selected compatibles

Contact Arcom Pacific for the name of your nearest dealer: Freepost 2, Clayfield Q. 4011; Phone (07) 52 3862. Dealer enquiries welcome.

The age of reason

displayed on a touch sensitive screen, and then manipulated using that screen to create an animated sequence. This leads back to Seymour's concept of 'subversive learning' — learning that is implicit, or indirectly related to the task in hand. In creating an animated sequence, children will learn about composition, continuity, design and all kinds of other peripheral skills.

Of course, most of these possibilities are demanding, in terms of both hardware and software: demanding and expensive. Greg argues that this is true of most projects during the research period. They start as huge systems running on sophisticated minis or mainframes, and eventually filter down to more reasonably priced systems as hardware capabilities increase and prices fall. Logo could be run only on one of half a dozen systems around the world while it was being developed. Today it runs on all machines costing a few hundred dollars.

QLogo requires about one megabyte of RAM, and either a 68000 or 16032 processor. Today these things cost in the region of twenty-five thousand dollars; in two or three years' time we'll find that sort of power in a standard desk-top micro.

Gesture offers a significant advantage over dedicated simulators in that it's under software control. The software is accessible to the user, and can be changed as required. The fact that the same system can form the basis of a large number of simulations will make the price appear more reasonable.

Gargarian wants to stress that both QLogo and Gesture are in the early stages of development. The research lab is concerned only with the development of ideas; it's the marketing side of Atari that has to make the decisions on whether to make a product commercially available. 'Most of the applications we have talked about are just ideas right now, but the possibilities are there,' Gargarian concluded.

END

Commodore Computer Software Programs.

Free 72 Page Full Colour Catalogue Available. Just Clip And Send The Coupon.



Now the most comprehensive range of software programs for your Commodore Computer can be delivered direct, anywhere in Australia, simply by ordering from the catalogue. It's the newest, easiest way of buying software for your Commodore Computer.

Perhaps 'user friendly' is the term we should apply to this new Commodore purchase system, because it brings the entire range of Commodore programs right into your home or office, eliminating the tiresome business of 'shopping.'

All new and existing programs, right across the entire category spectrum, are available. Just ask us. Anytime. But first, get your free catalogue by completing and sending the coupon.



commodore
COMPUTER
Keeping up with you.

Commodore Information Centre Pty Ltd
(Incorporated in N.S.W.)
Private Bag No. 21 Lane Cove West NSW 2066

Name _____
Address _____
Postcode _____

APC

BMS/CC173

THE BUSINESS ALTERNATIVE

'BASIS' MED-FLY

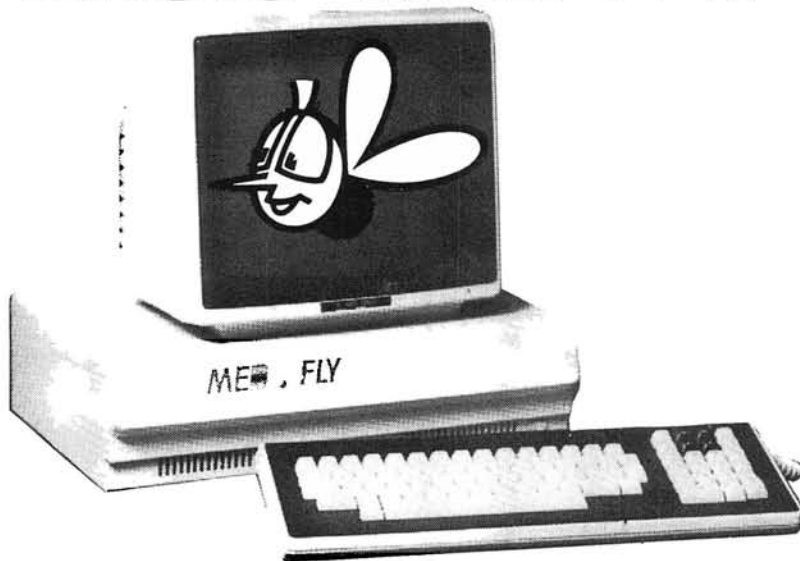

Standard Features

- 6502 and Z80 microprocessors
- 128K RAM
- 2K System ROM, plus sockets for 10K
- Additional user ROM
- RGB and Composite (NTSC or PAL) Video
- Selectable 80 or 40 Column text display
- High Resolution Graphics: Six Colors, 280 x 192 or 280 x 160 with four lines of text
- Color Graphic Mode: 15 Colors 40 x 48 or 80 x 48; 40 x 40 or 80 x 40 with four lines of text
- 8 bit parallel output
- RS-232c Serial I/O
- Detached Keyboard: All standard keyboard functions, Upper/Lower case characters, Numeric Keypad, Cursor Control Block
- Six Apple II compatible slots for plug-in peripherals
- Game paddle I/O
- Built-in loudspeaker
- Mounting slots for up to three DN-25 I/O plugs
- CP/M 3.0

Hardware and Software compatible with Apple II

LIMITED OFFER ONLY

WHILE STOCKS LAST

COMPUTER 128K
2 DISK DRIVES
&
CONTROLLER
MONITOR
CABLES &
ACCOUNTS
SOFTWARE

\$2330.00 Tax Paid

BUSINESS
ACCOUNTING
ACCOUNTS
PAYABLE
RECEIVABLE
INVENTORY
AND
GENERAL LEDGER
FULLY INTEGRATED
AUSTRALIAN DESIGNED

\$500.00 Inc Tax

MICRO ~ BUFF

TELEX AA 139718
TELEPHONE 277 7754 (ASK FOR RAY POPE)

**499 HIGH STREET ROAD,
MT WAVERLEY 3150
MELBOURNE, VICTORIA,
AUSTRALIA**

NETWORK NEWS

Peter Tootill and Steve Withers give their summary of what's happening in the telephone networking world.

New bulletin boards

There are a couple of new systems to report this month. The first is AMUG BBS, run by the Adelaide Micro User Group. The hours are fairly restricted (10am to 10pm weekends and public holidays only), but it's the first South Australian system we have heard about. The number is (08) 271 2043.

The other new system runs RCP/M and is available 24 hours a day, seven days a week. The operator is Phil Sampson of Darwin and the phone number is: (089) 277 111.

Doesn't anybody run a BBS in Tasmania?

Foreign bulletin boards

Here are a few numbers of systems a bit further afield for those of you with adventurous natures, and/or bottomless telephone money boxes!

United Kingdom

CBBS—SW, 24 hours a day, telephone: 0011 44 626 890 014.

BASUG, 6pm — midnight (local time), telephone: 0011 44 742 667 983.

Europe

CBBS—Helsinki, (times unknown), telephone: 0011 358 0 722 272.

South Africa

Connection 80 Cape Town, (times unknown), telephone: 0011 2721 457 750.

Ape Computer Club Cape Town, (times unknown), telephone: 0011 27 21 215 363.

Connection 80 Johannesburg, (times unknown), telephone: 0011 27 11 834 5135.

Durban, (times unknown), telephone: 0011 27 31 66 356.

Johannesburg, (times unknown), telephone: 0011 27 11 642 3722.

RS232 interface for Oric-1

We have heard that a Welsh company, Modular Concept Peripherals, has launched an RS232 interface for the Oric. Apparently it will handle a variety of baud rates and some software is included. The interface connects to the Oric expansion port, and the connector is carried through to enable other devices to be connected at the same time. We don't know if anyone is importing it, so for more details contact: Modular Concept Peripherals, 13 High Street, Clydach, Swansea SA6 5LF, United Kingdom. The UK price is £31.50 (around \$55).

HOME, PERSONAL, SCHOOL and BUSINESS COMPUTERS

 **commodore**

 **sirius**



Melbourne's largest range of programs
Friendly expert advice and service
Easy access — plenty of parking

OPEN SATURDAY MORNINGS
Established 1968 — Member of O.E.I.A.

Maxwell **OFFICE EQUIPMENT (VIC) PTY. LTD.**
162-164 NICHOLSON ST. ABBOTSFORD
(near Hoddle Street) Telephone: **419 6811**

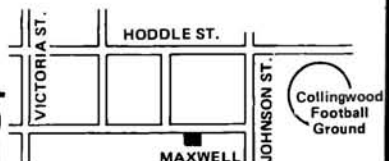

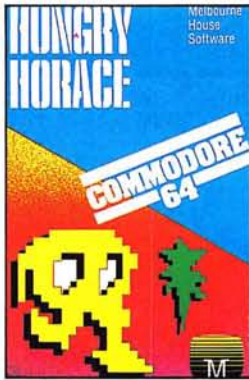

COMMODORE 64 HUNGRY HORACE Just when you thought computer games had nothing more to offer, here comes Horace for your Commodore 64. Hungry Horace creates havoc in the park as he picks the flowers, annoys the guards and steals their lunch. "Defining your own maze simply adds to the enjoyment of a great game." — PC Games

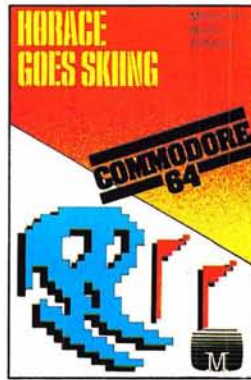

COMMODORE 64 HORACE GOES SKIING The sequel to the very successful Hungry Horace. Our hero attempts winter sports. First of all he must get to the ski shop, then lumbered with a pair of skis, he has to dodge the traffic once again to reach the snow. Skiing is complete with slalom flags, trees and moguls!

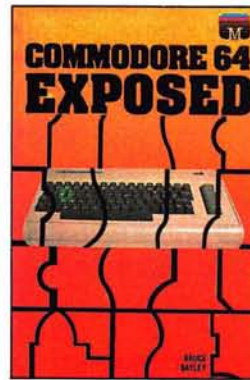

COMMODORE 64 EXPOSED A complete and comprehensive guide that clearly explains every function of your Commodore 64 from BASIC to Machine Language. Includes full details on advanced programming, graphics and sound. "A real gem. A most comprehensive and necessary publication." — Commodore Magazine

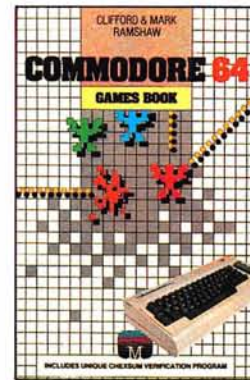

COMMODORE 64 GAMES BOOK Teach your Commodore 64 every trick in the book. 30 programs ranging from nerve-shattering space games to real life adventures. "For a Commodore 64 games enthusiast, this is a must." — Personal Computer News



A GUIDE TO PLAYING THE HOBBIT "The Hobbit" program has revolutionised adventure on Spectrum, Commodore 64, and Oric computers. This book whilst providing solutions to problems which are encouraged aims to preserve as far as possible the qualities of challenge and discovery which are so much a part of The Ho

COMMODORE

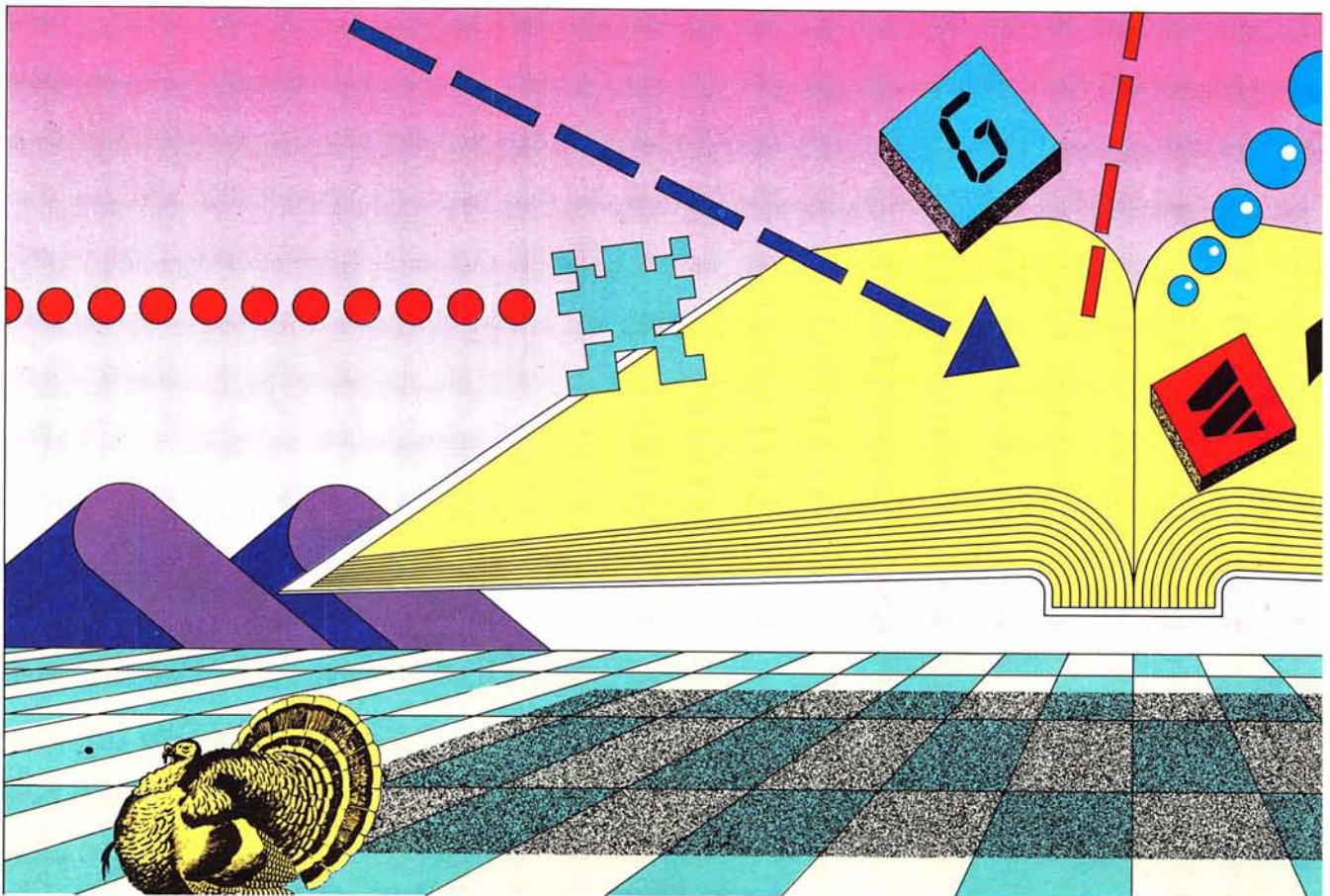

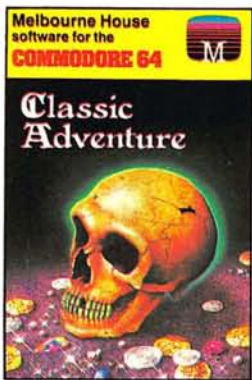

CLASSIC ADVENTURE This is the program that started it all! Now you can discover the excitement of Classic Adventure on your Commodore 64, and if you are masterful enough you too could become a Master Adventurer.



THE HOBBIT Visit J.R.R. Tolkien's Middle Earth with The Hobbit. The most amazing adventure yet devised. "The Hobbit has been transferred to run on the Commodore 64 and what a success it is."

— Which Micro? & Software Review.
 "1983 will go down in microadventure history as The Year of THE HOBBIT."
 — Popular Computing Weekly.



A.C.O.S.+ 36 new BASIC commands for your Commodore 64 covering the fields of cassette input and output, graphics, sound and utility commands. The A.C.O.S.+ program also allows the user to add his own BASIC commands. Includes a free demonstration game.

MELBOURNE HOUSE 64



H O U S E

TO: MELBOURNE HOUSE
 Suite 4, 75 Palmerston Crescent
 South Melbourne, 3205.
 Telephone (03) 690.5336.

Please send me your FREE catalogue
 I have a _____ K Microcomputer.
 Please send me:
 I enclose cheque/money order for \$ _____
 PLUS \$2.00 for postage
 Please debit my bankcard A/C for \$ _____
 A/C No. _____
 Commencement date _____
 Expiry date _____
 Name _____
 Address _____
 _____ Postcode _____
 Signature _____

Melbourne House guarantees to replace any faulty tapes immediately.

Dealer enquiries welcome.

Commodore 64

- The Hobbit \$39.95
- Hungry Horace \$20.00
- Horace Goes Skiing \$20.00
- Horace & The Spiders \$20.00
- Super Cassette A \$20.00
- Super Cassette B \$20.00
- Frogrun \$20.00
- Kong \$20.00
- Skramble \$20.00
- Hexpert \$20.00
- Moon Buggy \$20.00
- 3D Time Trek \$20.00

VIC 20

- VIC 20 Games Pack \$20.00
- The Wizard & The Princess \$20.00
- Mini Kong \$20.00
- Frogrun \$20.00
- Dotman \$20.00
- Slap Dab \$20.00
- Tiny Tots Seven \$20.00
- Games Pack (Vol. 1) \$20.00
- Crawler \$20.00
- Crazy Kong 16K \$20.00
- Pharaoh's Tomb 16K \$20.00
- The Dungeons 16K \$20.00
- 3D Time Trek 16K \$20.00
- Zok's Kingdom 16K \$20.00
- Xeno II 16K \$20.00
- Galactic Abductor 16K \$20.00

APC4



Network jargon

This month we have some information about the more common modem standards used for data communications on 'dial up' lines as opposed to special high quality leased lines for high speed data transfer. The most common modem standard is the 300 baud CCITT V21 standard used among others by bulletin boards and mainframe computers that operate as timesharing systems (used by telephone from terminals, not so common now that micros are so cheap and powerful).

The next most common is the V23 standard. These are both 'asynchronous' which means that there is no timing signal sent by the modem. The timing information is derived from start and stop bits at the beginning and end of each character, and the time between each character is not important.

Another, less common, standard is the CCITT V22, which is a 1200 baud full duplex standard. This was developed using synchronous techniques (the modem actually sends data in strictly timed blocks with timing information being transmitted as well), although it still communicates with the terminal in the same asynchronous way as the other two types.

There are many other standards in use

but these tend to be in commercial applications with mainframes, leased lines and the like, and are unlikely to be encountered except in larger companies with DP departments. The American Bell equivalents are also given in the following tables, together with some indication of the compatibility.

Australian systems

Micro Design Lab RCPM

We believe that the telephone number of the Micro Design Lab RCPM has been altered although no new number has been notified. We shall publish its new number as soon as it becomes available.

Mi Computer Club BBS

Telephone: (02) 662 1686. Program downloading. Hours: 24 hours daily.

Sydney Public Access RCPM

Telephone: (02) 808 3536. System Operators: Barrie Hull and David Simpson. Hours: 24 hours daily.

Software Tools RCPM

Telephone: (07) 378 9530. Hours: 24 hours daily.

MICOM CBBS

Telephone: (03) 762 5088. System

Operator: Peter Jetson. Hours: 24 hours daily.

Gippsland RCPM

Telephone: (051) 34 1563. System Operator: Bob Sherlock. Hours: 24 hours daily.

Sorcerer Computer Users Association CBBS

Telephone: (03) 836 4616. System Operator: Bruce Alexander. Program downloading for SCUA members. Hours: 24 hours daily.

TARDIS RCPM

Telephone: (03) 67 7760. Hours: 6pm — 8am weekdays. 24 hours weekends.

Perth RMPM

Telephone: (09) 367 6068. Hours: 6pm — 9pm WST.

Adelaide Micro User Group BBS

Telephone: (08) 271 2043. Hours: 10am to 10pm, weekends and public holidays only.

Darwin RCPM

Telephone: (089) 277 111. Hours: 24 hours daily.

American/Canadian systems

TYPE	SYSTEM NAME	NUMBER	NOTES
Forum 80	HQ system,	0011 1816 861 7040	
CBBS	HQ system	0011 1312 545 8086	
FBBS	HQ system	0011 1312 677 8514	
ABBS	Ottawa, Ontario	0011 1613 725 2243	
ABBS	HQ system	0011 1703 255 2192	
MABBS	Fort Walton Beach	0011 1904 862 1072	
Bull-80	Alabama	0011 1205 492 0373	
Conn-80	Colour Computer	0011 1212 441 3755	colour graphics for TRS-80 Colour

European systems

ELFA	ABC-MONITOR Sweden	00114.68 7300706	Half duplex
ABC-Banken	Halmstadt, Sweden	00114.63 5110771	
ABC-MONITOR	ABC Club of Sweden	00114.68 801523	Passwords required
CBBS	Gothenburg, Sweden	00114.63 1292160	75/1200 baud
		00114.63 1690754	300 baud
TEDAS	Germany	0011 4989 596 422	
CBBS	Helsinki, Finland	0011 3580 722 272	

UK systems

TYPE	SYSTEM NAME	NUMBER	NOTES
CBBS	North East	0011 44 207 543555	
CBBS	London	0011 44 1 399 2136	

NETWORK NEWS

Forum-80	Hull	0011 44 482 859169	
Forum-80	London	0011 44 1 902 2546	
Forum-80	Milton	0011 44 908 613004	
Mailbox-80	Liverpool	0011 44 51 428 8924	
TBBS	London	0011 44 1 348 9400	ring-back system
TBBS	Blandford	0011 44 258 54494	
BBS	Southern	0011 44 243 5111077	ring-back system
CBBS	South West	0011 44 626 890 014	
BASUG		0011 44 742 667 983	

BLUDNER

Last month we suggested that Bell 202 and CCITT V23 modems could talk to each other — sorry folks, they *can't*, and in any case Bell 202 modems would not get Telecom approval. If you had visions of importing one of those nice cheap 1200 baud modems that are advertised in US magazines, forget it. The good news is that 1200 baud modems are getting cheaper, although most of us will have to stay with 300 baud (or 1200/75) for some time.

Our thanks to Peter Jetson (sysop of the MICOM CBBS) for putting us straight on this subject.

African systems

Connection 80	Cape Town	0011 27 21 457 750
Ape Computer Club	Cape Town	0011 27 21 215 363
Connection 80	Johannesburg	0011 27 11 834 5135
	Durban	0011 27 31 66 356
	Johannesburg	0011 27 11 642 3722

* After receiving the tone and connecting your modem, either type: <C/R> or type <COM C/R>. The system then asks for a password which is 'cbbs' in small letters!! If you only get '>' when you dial up the systems needs resetting and you type <I> C R.

This information is correct and current to the best of our knowledge. Please send corrections and updates to: Steve Withers, C/- Australian Personal Computer, 77 Glenhuntsy Road, Elwood, Vic 3184.

CCITT Modem Recommendations

Speed Bits/Sec	Format:	Full/half Duplex	CCITT Reference	BT Datel Service	Bell Ref.	US
	Asynchronous or synchronous					Compatible? with CCITT
0-300	A	Full	V21	200	103	No
1200 2400	A&S	H/F	V22 V22bis	1200 —	212A	Yes at 1200b/s
1200 1200/75	A A	Half Full*	V23 V23	600 600	202	Sometimes

* The 1200/75 service is sometimes referred to as 'asymmetric duplex'.

Modem Operating Frequencies

Modem Type	Speed (Bit/s)	Duplex	Transmit Frequency		Receive Frequency		Answer Tone Freq Hz
			0	1	0	1	
			Hz	Hz	Hz	Hz	
CCITT V.21 Orig	<300	Full	1180	980	1850	1650	—
CCITT V.21 Ans	<300	Full	1850	1650	1180	980	2100
CCITT V.23 Mode 1	600	Half	1700	1300	1700	1300	2100
CCITT V.23 Mode 2	1200	Half	2100	1300	2100	1300	2100
CCITT V.23 Back	75	—	450	390	450	390	—
Bell 103 Orig	<300	Full	1070	1270	2025	2225	—
Bell 103 Ans	<300	Full	2025	2225	1070	1270	2225
Bell 202*	1200	Half	2200	1200	2200	1200	2025

Bell 202 has no back channel as such, only a 5 bit/sec on/off signal (387 Hz = on, no signal = off) used for handshaking. (CCITT V22 & Bell 212A do not use single frequencies like these and cannot be simply included in such a table.)

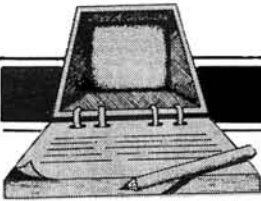

DIARY DATA

Readers are strongly advised to check details with exhibition organisers before making travel arrangements to avoid wasted journeys due to cancellations, printer's errors, etc.

Sydney	Data '84 Contact: Graphic Directions (02) 212 4199	May 22-24, 1984
Perth	International Microcomputer Conference and Exhibition Contact: (09) 325 4427	May 22-24, 1984
Perth	Microcomputer Exhibition Contact: Jenna Ledgerwood (09) 325 0111	May 22-25, 1984
Hong Kong	Percom '84 Contact: Adsale Exhibition Services. Tel: (Hong Kong) 5-892 0511	June 19-22, 1984
Las Vegas, USA	NCC '84 Contact: USA (703) 558 3612	July 9-12, 1984
Melbourne	3rd Australian Personal Computer Show Contact: Australian Exhibition Services. Tel: (03) 267 4500	July 18-21, 1984



MICRO EXCHANGE

All Micro Exchange ads must be submitted by readers on the appropriate form (or a photocopy). Maximum of 30 words. Print one word per box, very clearly. Contact name and telephone number/s must be included in the 30 words. All ads must be accompanied by a fee of \$5.00 for inclusion in Australian Personal Computer. Make cheques or Postal Orders payable to Micro Exchange. Ads cannot be repeated (unless sent on another form) and we cannot guarantee to print an ad in any specific issue. Please help the typesetter by printing very clearly. Send your form to: Micro Exchange, C/- Australian Personal Computer, 77 Glenhuntly Road, Elwood, Victoria 3184.

AUSTRALIAN CAPITAL TERRITORY

OSBORNE 1 GRAPHICS ADVENTURE GAME. THE FIRST OF IT'S KIND IN THE WORLD FOR OSBORNE. IT'S YOURS FOR \$29.95 PLUS \$2 P&P BY PHONING AEDN SOFTWARE DN (062) 477550 TODAY.

OSBORNE 1 SOFTWARE LARGE RANGE OF APPLICATIONS SOFTWARE FOR OSBORNE. (SPECIALISING IN GRAPHICS SOFTWARE) ALSO: PUBLIC DOMAIN DISKS, IMPROVED BIOS, HARDWARE AND MORE. PHONE AEDN SOFTWARE DN (062) 477550 FOR FREE CATALOGUE.

OSBORNE 1 IMPROVED BIOS: THE A V BIOS FEATURES MORE DISK SPACE, MORE DISK TYPES, MORE FUNCTION KEYS AND MORE SENSE!! ONLY \$59.95 FROM AEDN SOFTWARE 2/19 GODFREY ST, CAMPBELL, A.C.T. 2601 + \$2 P&P

8088 CARD FOR APPLE WITH MEMORY EXPANSION BOARD TO 128K WITH CPM/86 AND MANUALS. \$630 ALSO AD/DA APPLE CARD \$75 PHONE CHESS (062) 823714

NEW SOUTH WALES

DISK, 80+ PROGRAMS, APPLE II, COMPATIBLES, GREAT VARIETY OF INTERESTING PROGRAMS OF ALL TYPES, \$20. INCLUDES TWO CUSTOM MADE TITLE SLIDES. ALLAN CROUCH, 80 AUBURN ROAD AUBURN NSW (02) 649 4904

MICROBEE DUAL DISK DRIVES PLUS SOFTWARE SUCH AS WORDSTAR MULTIPLAN AND MICROSOFT BASIC. THE DRIVES AND SOFTWARE JUST \$1000.00 PHONE (02) 774 2479

SORCERER MK2 48K WITH GREENSCREEN MONITOR, MICROPOLIS DRIVES, 18 SLOT

EXPANSION CHASSIS, ROM PACKS, NUMEROUS BOARDS, LOTS OF SOFTWARE ON DISC AND TAPE \$2800 (049) 488742

SYS-80 TRS-80 I LIKE TO BORROW AND LEND TAPE SOFTWARE. PLEASE SEND YOUR LIST TO MR. GILBERT 25 PALONA ST MARAYONG NSW 2148. YOU WILL RECEIVE MY LIST IN RETURN.

VIC 20 GAMES CASSETTES \$4 EACH. SEND S.S.E. FOR FREE BROCHURE. 17 NELSON ST, THORNLEIGH 2120 OR RING (02) 84 6860 OR (02) 534 4136

QUEENSLAND

FOR SALE: SYSTEM 80 PROGS MOSTLY GAMES. ONE DATA MANAGER. FOR LIST OF TAPES WRITE TO: DAMIEN JARDINE P.O. BOX 899 INGHAM QLD 4850

Nissei Sangyo

One of the world's largest system, marketing and sales organisations!

It's not so important that you know our name. Although, Internationally, we are well-known marketing and sales specialists of electronic products — and a turnover of more than A\$1,400 million speaks for itself. However, it is much more important for us that you are impressed by our products:

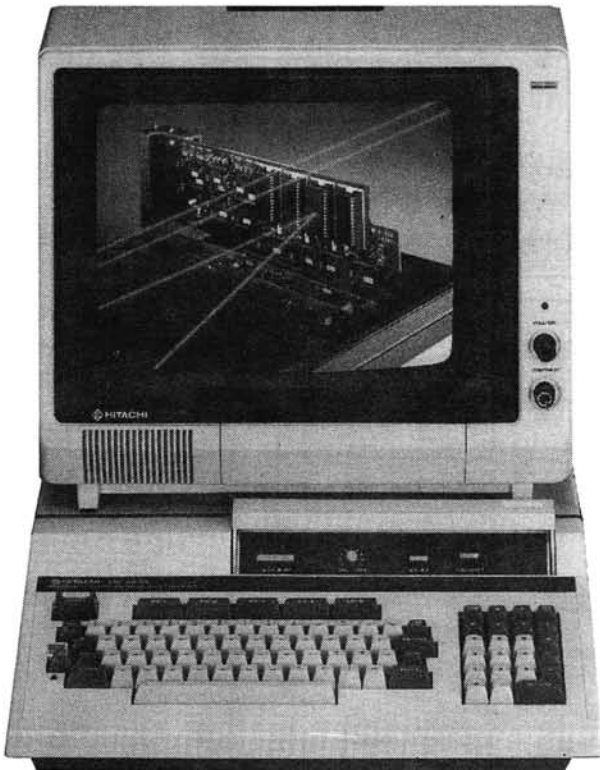

Greater Performance Personal Computer HITACHI MB-6890K PERSONAL COMPUTER

Specification: MC-6809, memory (24KB ROM, 32KB RAM standard), Interface (Monochrome & Colour R.G.B. Monitor Interface, Light Pen Interface, Parallel & RS232C Interface), Expansion Slots (Five Slots), Popular Software, including CP/M Card* available (Optional).



Personal Computer, The better Business Solution

Professional, High Performance Business Computer HITACHI MBE-16000 SERIES PERSONAL COMPUTER

Specification: Intel 8088, 8087 Option, memory (320KB RAM expandable upto 512KB), Interface (Monochrome & R.G.B. Colour Monitor Interface, Parallel & RS232C Interface, Light Pen Interface), Expansion Slots (Four Slots), Built in Two 320KB Mini Floppy Drives, Popular Software on MS-DOS is available.

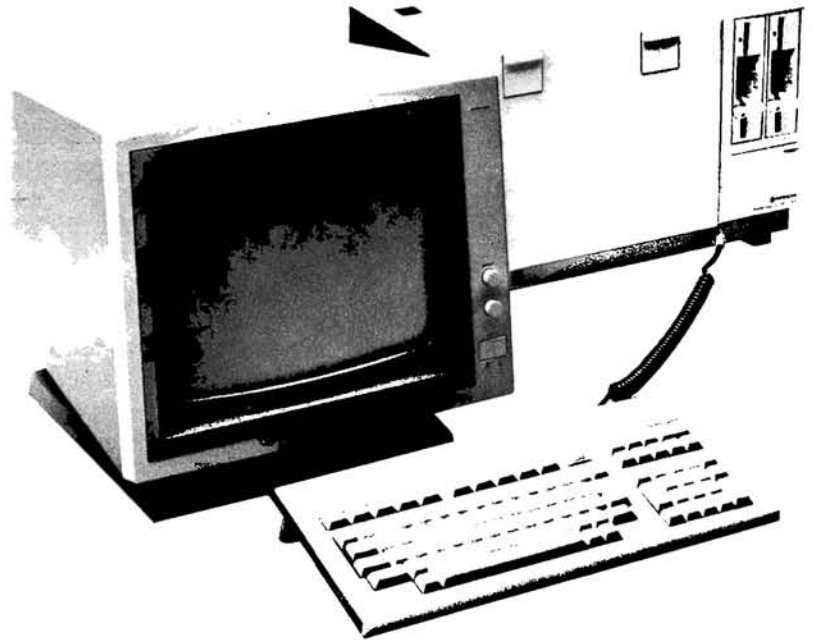

For your local dealer, please contact:



Nissei Sangyo Co., Ltd.

INCORPORATED IN JAPAN
200 PACIFIC HIGHWAY, CROWS NEST
N.S.W. 2065 AUSTRALIA

TELEPHONE (02) 923 1522 (4 lines)
TELEX AA70941
FACSIMILE (02) 922 2498

NSA

MICRO EXCHANGE

OSBORNE 1 PERSONAL COMPUTER - DOUBLE DENSITY WITH C-ITOH 8510A GRAPHIC PRINTER - STANDARD SOFTWARE PACKAGE AND SEVERAL OTHER POWERFUL SOFTWARE PACKAGES. 6 MONTHS WARRANTY. \$2800 O.N.O. CONTACT TERRY BRUNET (08) 46-9333 A.H. (08) 297-8407

OSI C2-4P 32K USER RAM 24K ROM. EXTENDED BASIC, WORD PROCESSOR, ETC INBUILT. SOUND AND SPEECH OUTPUTS. SPEAKS UNDER BASIC CONTROL. \$700. WAYNE GEARY, 83 SECOND AVE, ROSSMOYNE 6155 (09) 457 8809

VICTORIA

64K RAM INSTALLED IN TRS-80 COLOR COMPUTER FOR \$90. DROP OFF AND PICK UP THE NEXT DAY. PLEASE RING FIRST. DON MCKENZIE 29 ELLESMERE CRES., TULLAMARINE 3043 (03) 3386286

DOUBLE SIZE EPROMS FOR MEDFLY, SWITCH SELECTED. HAVE TWO SEPARATE BASIC INTERPRETERS E.G. BASIS FP80

AND APPLESOFT ALWAYS AVAILABLE. FULL SET \$80 COMPLETE WITH FITTING INSTRUCTIONS. PHONE PETER A.H. (03) 589 2072.

FIT 64K, 64K? YES 64K OF USEABLE RAM IN SYS-80 AND TRS-80 MODEL ONE COMPUTERS FOR AROUND \$70. SEND \$5 FOR INSTRUCTIONS TO DON MCKENZIE 29 ELLESMERE CRES., TULLAMARINE 3043

FOR SALE: BUSINESS OR ADVANCED HOBBY SYSTEM. SYSTEM-80 COMPUTER, EXPANSION INTERFACE, TEXT/GRAPHIX DOT MATRIX PRINTER, PLUS \$700 SOFTWARE. ALL EXCELLENT CONDITION. WORTH OVER \$2500 SELL FOR \$1500. PHONE (03) 359 1884 A.H.

HARDWARE HACKERS. SPEED UP YOUR TRS-80 MODEL ONE, OR SYS-80 TO THREE TIMES NORMAL SPEED. 5.3 MHZ. BENCHMARK TESTS COMPARE CLOSELY TO I.B.M. PERSONAL COMPUTER. BARE P.C. BOARD \$12 DON MCKENZIE (03) 3386286

NEW CHARACTER ROM FOR C.ITOH 8510 OR 1550 PRINTERS. HAVE ASCII, GRAPHICS, GREEK & ITALICS (REMOVE KATAKANA) \$45 YOUR CHARACTERS ARRANGED. FITTING INSTRUCTIONS PROVIDED. PHONE PETER A.H. (03) 589 2072.

SYS-80 AND TRS-80 MODEL ONE USERS. SEND ME A 60C STAMP AND I WILL FORWARD YOU MY CATALOGUE ON AVAILABLE MODIFICATIONS. DON MCKENZIE 29 ELLESMERE CRES., TULLAMARINE 3043

TRS-80 MODEL III WITH TWO DISK DRIVES, 48K, TRSDOS, AND ALL MANUALS IN EXCELLENT CONDITION. 1 YEAR OLD. HARDLY USED COST \$3000 SELL \$2000 A.H. (03) 729 5541

VIC-20 INTERNAL MEMORY EXPANDERS. NO SOLDERING PLUG IN INSTALLATION 8K \$45 16K \$73 24K \$100 ADD \$5 FOR JAPANESE MODELS. EXPANDABLE ON BOARD LATER \$28 PER 8K MARK PANTHER (03) 543 3217

Please find enclosed my cheque/P.O. for \$5.00/\$7.50 for the following ad:

NAME..... ADDRESS.....

LAZING AROUND

by J J Clessa

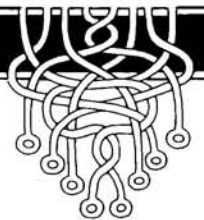

Quickie

Of 50 people interviewed 27 liked cricket, 32 liked football and five didn't like either. How many people liked both cricket and football?

Prize puzzle

The Smiths and Jones families each have three children who work for the local council. By coincidence, the salaries of the three Smith children are in the same proportions as those of the three Jones children.

Moreover, Albert Smith and Paul Jones have the same salary — as do

Mary Smith and Sally Jones. However, Peter Jones earns \$387 per month more than Michael Smith. What is the salary of each.

Answers please — postcards or backs of sealed envelopes only — to reach APC not later than 15 May, 1984. Send your entries to APC April prize puzzle, Lazing Around, 77 Glenhantly Road, Elwood, Victoria 3184.

January prize puzzle

Not too difficult to solve analytically, although it's a bit harder to solve by trial

and error using a micro. Naturally, it isn't possible to say which of the two scores is for the penalty and which is for the field goal, but the scores must be 4 and 17.

This prohibits scores of:
1 2 3 5 6 7 9 10 11 13 14 15 18 19 22
23 26 27 30 31 35 39 43 and 47 —
twenty-four in all.

The winning entry, drawn at random from over sixty, came from Richard Buckdale of Enmore, NSW. Congratulations, Mr Buckdale, your prize is on its way.

Don't forget — please send entries on postcards (backs of sealed envelopes will do). Letters are immediately disqualified.

PROGRAMS

APC is interested in programs written in any of the major programming languages for all home and small business micros. When submitting programs to APC please include the following:

- (a) A cassette or disk of the program.
- (b) A listing on plain, white paper (typewritten if no printer available).
- (c) Comprehensive but brief documentation,
- (d) A suitable SAE if you would like your materials to be returned after use.

Please mark (a), (b) and (c) with your name, address, program title, machine (state minimum RAM where appropriate) and — if possible — a daytime number.

All programs must, please, be fully debugged.

Programs are paid for at the rate of \$20 per page of published listing. Send contributions to:

APC Programs, 77 Glenhuntly Road, Elwood, Vic 3184.



Games



Scientific/mathematic



Business



Toolkit/utilities



Educational/Computer Aided Learning



Microsoft Basic Inlay Cards

by Ian Masters

Inlay cards' is a short and simple print program, producing blank cassette inlay cards which have space for up to 21 programs per side. Inlay cards supplied with cassettes often don't have enough room to record details of all the programs on a

C-60 or C-90 tape.

Written in completely standard MBasic, the program should run on any machine supporting an LPRINT USING statement.

- 10 *CASSETTE BOX INSERTS by Ian Masters
- 20 *28 Sept 1983 in Microsoft Basic
- 30 *For use with MX100 Printer and 128
- 35 *column paper.
- 40 *The program will produce 6 cassette
- 50 *box inserts per sheet of 128 col by
- 60 *11 inch paper. Don't be tight, use
- 70 *good paper 80gsm and a good ribbon,
- 80 *for best results.

TANDY

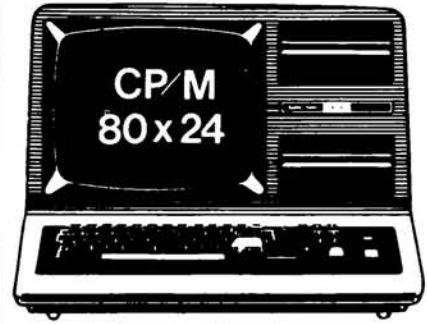

★ DISK CONTROLLER*

A premium controller for the Model 3 Tandy Computer. Double density with precision LSI Data Separator for reliable performance. Mix 5 and 8 inch drives. Battery powered. Clock/Calendar and gold plated edge connectors included. Sold by itself or in complete kit with Switching Power Supply. Drive brackets, cables and hardware and fitting instructions.
PRICE — \$530. Disk Drives at competitive prices. Also fits Model 4.

★ VIDEO — CP/M EXPANSION

Your Model 3 can have 80 column by 24 lines video display, and ability to run a 64K CP/M Operating System, and even an extra 64K bank of memory, YET STILL OPERATE IN ITS ORIGINAL FORM WHEN REQUIRED. The VID-80 fits inside the computer and is simply installed following our instructions.
PRICE — \$365, CP/M \$199, extra 64K \$116

★ SPRINTER

Plug-in circuit with Z80B CPU to reliably "ho up" the Model 1 or 3 by increasing the clock speed (but slowing down when required). Model 1 version optionally with Parallel Printer Port.
PRICE — \$135. Model 1 with Printewr Port \$167

STOP PRESS

(NOW AVAILABLE for SYSTEM 80)

★ MODEL 1 DISK CONTROLLER

Includes printer interface and plugs straight into keyboard! With Slim-line 40 track drive. LSI Data Separator, gold plated connectors. Double Sided and Double Density. Only \$700

★ MODEL 1 DOUBLERS

If you have drives, increase reliability and double storage with our Double Density Adaptors \$179.

MODEL 4 MEMORY KITS

16K — 64K with instructions \$119
64K — 128K with instructions \$160

ALL PRICES INCLUDE SALES TAX BUT ARE SUBJECT TO CHANGE. SEND YOUR NAME AND ADDRESS FOR COMPLETE PRICE LIST AND OUR NEW NEWSLETTER... FREE!

NOTE NEW PHONE NUMBER AND ADDRESS



MICROCOMPUTERS

P.O. BOX 259,
CAULFIELD EAST, VIC 3145
Telephone: (03) 500 0628

**WE HAVE MOVED
OPENING SPECIAL**

APPLE COMPATIBLE DISK
DRIVE WITH CONTROLLER

\$300.00 inc tax

CW COMPUTERWARE

WE ARE NOW AT

**333 LATROBE STREET
MELBOURNE 3000**

Telephone: (03) 602 1006

**MONITORS
MONITORS
AND MONITORS
GREEN, AMBER, RGB**

Australia's best quality
monitors at the lowest price.

IBM, Apple, Commodore,
Sharp, MicroBee, Atari etc.

From **\$159** inc tax

Send for details from:

**P.O. BOX 217
PETERSHAM 2049**

VZ 200 SOFTWARE

BOY SCOUT: \$8.00

In this game the player is a Cub Scout attempting his good deed for the day namely to help an old lady across the road through cars and buses. Then you take the old lady across a river by jumping on logs and turtles.

ASTEROID FIELD: \$6.00

The player has to fly a ship through a series of asteroid fields shooting as many asteroids as possible without being hit. Each field moves faster than the last. Joystick or keyboard.

ALIEN ESCAPE: \$7.60

Find your way to a shuttle, eating as many dots as you can on your way. Beware of the ever growing alien. Alien Escape makes full use of the VZ-200's sound and graphics facilities. Keyboard or joystick.

MARS LANDER: \$6.00

A difficult game where the player has to land urgent supply capsules on Mars. If the capsule doesn't burn up, it can easily smash on impact or miss the pad. A game requiring much skill. Hi-resolution graphics.

All above games run on 8K RAM

All four of these programs on one

cassette **\$25.00**

Post free in Australia.

Send S.A.E. for complete April catalogue. Trade enquiries welcome.

If you have any programs which you wish to market and are of marketable quality, please write to us for terms.

LYSCo

P.O. Box 265, Bunbury. W.A. 6230

PROGRAMS

```

90 '140 sets line spacing to 1/4th inch
100 '150 sets the emphasised mode ON.
110 A$=STRING$(40," ")
120 B$=STRING$(18," ")
130 C$=STRING$(19," ")
140 LPRINT CHR$(27);CHR$(50)
150 LPRINT CHR$(27);CHR$(69)
160 FOR Z=1 TO 2
170   LPRINT A$;" ";A$;" ";A$
180   FOR I=1 TO 15
190     LPRINT USING"##";I;
200     LPRINT B$;"!";C$;" ";
210     LPRINT USING"##";I;
220     LPRINT B$;"!";C$;" ";
230     LPRINT USING"##";I;
240     LPRINT B$;"!";C$
250   NEXT I
260   LPRINT:LPRINT
270   LPRINT A$;" ";A$;" ";A$
280   FOR X=16 TO 21
290     LPRINT USING"##";X;
300     LPRINT B$;"!";C$;" ";
310     LPRINT USING"##";X;
320     LPRINT B$;"!";C$;" ";
330     LPRINT USING"##";X;
340     LPRINT B$;"!";C$
350   NEXT X
360   LPRINT:LPRINT
370 NEXT Z
380 END

```



BBC Splash!

by Jeff Aughton

'Splash!' is an infuriating strategy game for a 32k BBC Micro. A colour display is essential to the game unless you happen to be a genius at working out grey scales!

The game is played on a 7 x 7 board and is based on waves. If you drop a stone into a pond, ripples will spread outwards from the centre. If you then drop another stone into a different part of the

pond, the second set of ripples will interfere with the first. Predicting the way in which a further stone will affect the existing pattern of ripples is what the game is all about. Full instructions are given within the program.

Seasoned APC Programs readers will spot the Jeff Aughton touch — who else could call a delay procedure with the statement PROCrastinate?

```

10 REM SPLASH - A GAME BY J.AUGHTON (FOR P.E.)
20 MODE7:VDU 23,1,0;0;0;0;
30 PROCrules
40 PROCinitialise
50
60 REPEAT
70 MODE2:VDU 23,1,0;0;0;0;
80 PROCstart
90 PROCboard
100 REPEAT
110 MZ=3-MZ
120 COLOUR7:COLOUR128
130 IF MZ=1 THEN PROCyou ELSE PROCme
140 IF TotZ(MZ)>24 THEN Win=1
150 UNTIL Win
160 PROCgover

```

RUN APPLE AND CPM PROGRAMMES ON THE REDSTONE

If the government pursues its current intentions retailers may not be able to sell some Apple workalikes. If you leave it too long you may be too late. Compak import the Redstone brand of computers that are specially good workalikes. First class manufacturing quality and packed with extra features.

As to its quality WE OFFER AS STANDARD A FULL SIX MONTHS GUARANTEE. Labour, parts, the lot. What's more, if you want it we will give you a special return to base service contract for the next six months for a measly \$25. That ought to prove it's top quality Features? It's packed with extras even Apple left out. Twin processors . . . 6502 and Z80. Two computers for the price of one so you can run both Apple and CPM software.



64K of RAM
12K ROM
Automatic repeat on all keys
Programmable function keys
Fixed function keys

**All this
for \$585
inc tax**

Upper/lower case
Numeric keyboard
7 expansion slots
Software and hardware compatible with the Apple II +

COMPAS PASCAL

THE IDEAL DEVELOPMENT AND EDUCATIONAL TOOL

The 16 Bit Versions now with interface routines for GSX graphics package

You probably won't believe COMPAS until you've seen it!

australian
Micro
computer magazine

Software Report Card

Compas
Pascal

	Poor	Fair	Good	Excellent
Setup	<input type="checkbox"/>	<input type="checkbox"/>	<input type="checkbox"/>	<input checked="" type="checkbox"/>
Ease of Use	<input type="checkbox"/>	<input type="checkbox"/>	<input type="checkbox"/>	<input checked="" type="checkbox"/>
Performance	<input type="checkbox"/>	<input type="checkbox"/>	<input type="checkbox"/>	<input checked="" type="checkbox"/>
Documentation	<input type="checkbox"/>	<input type="checkbox"/>	<input type="checkbox"/>	<input checked="" type="checkbox"/>
Serviceability	<input type="checkbox"/>	<input type="checkbox"/>	<input type="checkbox"/>	<input checked="" type="checkbox"/>

See review in September issue

You probably won't believe COMPAS until you've seen it. Standard Pascal in a single 32K-byte program, including an advanced on-screen editor. Compiling 6000 lines per minute directly into native machine code (not slow p-code), which runs faster than anything yet seen. Well, it's true, and it's there

COMPAS Pascal closely follows the definition of Standard Pascal, as set forth by Jensen & Wirth in the "Pascal User Manual and Report". Furthermore, several extensions are offered by COMPAS, to make it the most complete implementation of Pascal ever seen on a microcomputer.

Now available in both 8 and 16-bit versions for:

**CP/M*, Apple* with Softcard
PC-DOS*, MS-DOS*, CP/M-86***

* registered trademarks

SOME OF THE COMPAS FEATURES:

- Wordstar* like editor
- Dynamic strings
- Random access data files
- Structured constants
- Free ordering of sections within declaration part
- Alphanumeric labels
- Control characters in string constants
- Type conversion functions
- Program chaining with common variables
- Program overlying
- Include files
- Full support of operating system facilities
- Logical operations on integers
- Bit/byte manipulation
- Direct access to CPU memory and data ports
- Absolute address variables
- In-line machine code and external subroutines

PRINTER PRICES SLASHED



CP-80

9 Pin Centronics Tract/Fric, Dot Graphics
\$269.10 (25+) **\$299.00** (1+)



DWX-305

Qume Compatible 18 Char/Sec, proportional
 13 in Platten Bi-directional, 256 Char Buffer
 Serial Parallel I/F
\$449.10 (25+) **\$499.00** (1+)

energy CONTROL

ROCKWELL
Synertek

P.O. Box 6502, Goodna, Qld. 4300 Brisbane Australia
 Phone: 61-7-288 2455 - 288 2757 Telex: AA43778 ENECON
 P.O. Box 12153, Wellington North, Wellington New Zealand
 Phone: 64-4-72 6462

MICROMEDIA

P.O. Box 298, Cannington W.A.
 Telephone: (09) 451 1028

ZX SPECTRUM

Destroyer. Specmen 3-D Maze. ZX Trek*.
 The Quest*. Orb*. Startrek. ZX 5 game pack
 *PK SPECTRUM REQUIRED

VIC-20

Terminator. Cosmic Knockout. Orb*. Startrek*. City
 Bomber. Snake Charmer. Perilous Post. 4 game pack
 *PK REQUIRED

All the above **\$10.00** each. 3 for **\$25.00**

BBC MACHINE

747 Flight Simulator **\$20.00**
 Blast Arcade Game **\$15.00**
 Tableteacher - 5 Educational
 Programs 7 years and over **\$20.00**

All programs in High-Res graphics and machine code
 Prices include Post and Packing

SOFTPAC ENTERPRISES

software for

CBM 64 — VIC-20 SPECTRUM

unbeatable prices
 send for catalogue
 state computer type

**P.O. Box 2350
 Sth. Hedland
 W.A. 6722**

PROGRAMS

```

170 PROCyorn("ANOTHER GAME? (Y/N)")
180 UNTIL No
190 END
200
210 DEFPROCinitialise
220 DIM AZ(11,11),Tot%(2)
230 DIM Tab1 24,Tab2 24,Board 121
240 Temp=#70:Tot=#71
250 Blank#:=CHR$(30)+STRING$(20," ") +CHR$(30)
260 PROCtable(Tab1)
270 FOR I%=1 TO 11:FOR J%=1 TO 11
280 PROCupdate(I%,J%,-1)
290 NEXT J%,I%
300 PROCass
310 ENDPROC
320
330 DEFPROCstart
340 CLS:RESTORE 2990
350 PROCtable(Tab2)
360 FOR I%=3 TO 9:FOR J%=3 TO 9
370 PROCupdate(I%,J%,0)
380 NEXT J%,I%
390 First=1:Win=0:Tot%(1)=0:Tot%(2)=0
400 PROCyorn("Want to start? (Y/N)")
410 IF Yes THEN M%=2 ELSE M%=1
420 PROCcrastinate(200)
430 ENDPROC
440
450 DEFPROCboard
460 CLS
470 GCOLOR,5:COLOUR6
480 FOR I%=96 TO 992 STEP 128
490 MOVE I%,64:DRAW I%,736
500 NEXT
510 FOR I%=64 TO 736 STEP 96
520 MOVE 96,I%:DRAW 992,I%
530 NEXT
540 PRINTTAB(2,6)"A B C D E F G"
550 FOR I%=1 TO 7
560 PRINTTAB(0,7+3*I%);I%
570 NEXT
580 FOR C%=0 TO 4
590 I%=11:J%=C%+4:PROCshade
600 PROCupdate(I%,J%,-1)
610 NEXT
620 COLOUR0:COLOUR135
630 PRINTTAB(0,31)"Score: You=0 Me=0 ";
640 ENDPROC
650
660 DEFPROCyou
670 PRINTBlank#;"Letter? ";
680 REPEAT
690 Y%=GET 62
700 UNTIL (Y%>2 AND Y%<10) OR Y%=19
710 IF Y%=19 THEN PROCquit ELSE PROCcont
720 ENDPROC
730
740 DEFPROCcont
750 VDU X%+62
760 PRINTTAB(11,0)"Number? ";
770 REPEAT
780 Y%=GET-46
790 UNTIL Y%>2 AND Y%<10
800 VDU Y%+46
810 IF AZ(X%,Y%)>=0 THEN PROCplay("Y") ELSE M%=2
820 ENDPROC
830
840 DEFPROCquit
850 PROCyorn(Blank#"Want to quit? (Y/N)")
860 IF Yes THEN Win=2 ELSE M%=2
870 ENDPROC
880
890 DEFPROCme
900 PRINTBlank#;"It's my move..."
910 PROCcrastinate(150)
920 IF First THEN PROCquess ELSE PROCthink
930 PRINTBlank#;"I will move to ";
940 VDU X%+62,32,Y%+46
950 PROCcrastinate(200)
960 PROCplay("M")
970 ENDPROC
980
990 DEFPROCquess
1000 First=0
1010 REPEAT
1020 XX=RND(9):YZ=RND(9)
    
```

PROGRAMS

```

1030 UNTIL A%(X%,Y%)>=0
1040 ENDPROC
1050
1060 DEFPROCthink
1070 IF Tot%(1)>20 THEN RESTORE 3040:PROCTable(Tab2)
1080 IF Tot%(2)>22 THEN RESTORE 2990:PROCTable(Tab2)
1090 Max%=0
1100 FOR X%=3 TO 9:FOR Y%=3 TO 9
1110 IF A%(X%,Y%)>=0 THEN PROCchoose
1120 NEXT Y%,X%
1130 X%=X1%:Y%=Y1%
1140 ENDPROC
1150
1160 DEFPROCchoose
1170 ?(Temp)=11*Y%-11+X%
1180 CALL BEST
1190 IF ?(Tot)>Max% THEN Max%=?(Tot):X1%=X%:Y1%=Y%
1200 ENDPROC
1210
1220 DEFPROCplay(A#)
1230 PROCsplash(0,200,A#)
1240 PROCsplash(1,100,A#)
1250 PROCsplash(2,100,A#)
1260 ENDPROC
1270
1280 DEFPROCsplash(D%,W%,A#)
1290 FOR I%=X%-D% TO X%+D%
1300 FOR J%=Y%-D% TO Y%+D%
1310 C%=A%(I%,J%)
1320 SOUND 17+D%, -9,4*RNDD(20)+40+D%,8 0+D%
1330 IF C%=0 THEN PROCshade
1340 IF C%=4 AND D%=2 THEN PROCtake(A#)
1350 NEXT J%,I%
1360 PROCastinate(W%)
1370 ENDPROC
1370
1380 DEFPROCshade
1390 IF C%=7 THEN K%=1 ELSE K%=(C%+1)MOD8+2*(C%=4)
1400 PROCupdate(I%,J%,K%)
1410 GOTO 8%(I%,J%)
1420 MOVE128*I%-280,932-96*J%
1430 MOVE128*I%-168,932-96*J%
1440 PLOT81,-112,88:PLOT81,112,0
1450 ENDPROC
1460
1470 DEFPROCtake(A#)
1480 COLOUR0:COLOUR135
1490 PRINTTAB(2*I%-4,3*J%+1):A#
1500 PROCupdate(I%,J%,-1)
1510 Tot%(M%)=Tot%(M%)+1
1520 PRINTTAB(11,31):Tot%(1):
1530 PRINTTAB(17,31):Tot%(2):
1540 ENDPROC
1550
1560 DEFPROCupdate(X%,Y%,K%)
1570 A%(X%,Y%)=K%
1580 ?(Board+11*Y%-11+X%)=A%
1590 ENDPROC
1600
1610 DEFPROCtable(X%)
1620 FOR I%=0 TO 25
1630 READ Y%
1640 ?(X%+I%)=Y%
1650 NEXT I%
1660 ENDPROC
1670
1680 DEFPROCastinate(W%)
1690 I%=TIME
1700 REPEAT UNTIL TIME-I%>W%
1710 ENDPROC
1720
1730 DEFPROCcover
1740 PROCastinate(200)
1750 COLOUR7:COLOUR128:CLS
1760 IF Win=1 THEN PROCcomment ELSE PROCabandon
1770 ENDPROC
1780
1790 DEFPROCcomment
1800 D%=ABS(Tot%(1)-Tot%(2))
1810 A#="That was a near one!"
1820 IF D%<2 THEN A#="WOW! - a close game!"
1830 IF D%<4 THEN A#="What a good game!"
1840 IF D%<6 THEN A#="An easy win!!"
1850 IF D%<8 THEN A#="A MASSACRE!!!!!!"
1860 PRINT A#
1870 IF Tot%(1)>Tot%(2) THEN A#="YOU WIN" ELSE A#="I WIN"

```

DIRECT IMPORTERS

Volume purchases, cutting out the middlemen, brings really low prices...and we've got the full service facilities of 220 Telephone Supply as our backup.

RABBIT (64/VIC-20) \$65

The 1984 version that busts copy protection (Wonder why the software houses don't like it?). Loads 8k of data in 31 seconds instead of 3 minutes. Your Datasette becomes almost as fast as disk and one C30 cassette holds 300K (nearly two disks full).

ARROW (even faster!) \$79

Half as fast again as Rabbit and tells you the lengths of LOADs and SAVEs.

SIMONS BASIC Cartridge \$65

With book. Cartridge adds 114 new commands to your Commodore. Draw SHAPes and color them with 18 commands. 15 screen commands. SCRSV to save your pics to tape, 8 sprite commands, lots more.

FLT. SIMULATOR from \$59

In machine language for fast reactions. Produces a screenful of instruments and forward windshield view. Use either keyboard alone or with joystick. CBM64 version with 7 airports \$65 (Tape) or \$69 (Disk). VIC-20 (needs 16K exp) has 5 airports \$59 (T), \$65 (D). TRS 80 Model 100 version \$65 (Tape only). Apple 2+ \$85 (Disk only).

ASTROLOGY ANALYSIS \$85

Widely used by professional astrologers in USA. Gives in-depth analysis telling point by point what the stars say about love-life, career, etc. For individual horoscopes. CBM 64 Disk only.

AUTOMODEM (64/20)..... \$195

Made by Commodore, Auto-answer, Auto-dial, Full/half duplex, Bell 103, 300 baud. Fitted with Aust. phone plugs. Included FREE is \$200 of access and user time to US data banks, including GO CBM, the Commodore information service in Pennsylvania AND cassette of software. Plugs direct into your Commodore and needs no extra power source. NOT Telecom approved.

TELSTAR Cartridge..... \$95

Upload/download from tape or disk. For use with Commodore Automodem. 9 Quick Read functions. Automatic file translation, real time clock plus alarm. Menu driven.

MACHINE LANG. MONITOR

For only \$55. More than 20 commands incl. assemble, disassemble, registers, memory, transfer. Someday, every CBM owner will need a monitor like this.

Vixen RAM Cartridge..... \$105

For VIC-20. Switchable between 16K, 11K, 8K and 3K. Gives 16,384 bytes of extra memory in blocks 1 and 2 or 3092 bytes in the 3K location PLUS 8192 bytes switchable between 1 and 3.

Switch Motherboard..... \$95

Gives four cartridge expansion slots (2 fully switchable). Plugs directly into the VIC-20. No extra power needed.

Dual SUPER DRIVE \$1650

For all Commodore computers from the VIC-20 to the big 8000 series. All metal heavy industrial quality to last a lifetime. With 2 serial and one parallel port, 8K RAM and 16K ROM and interlace for CBM64 and VIC-20. Faster by far than the plastic body 1541 single drives, these Super Drives turn your Commodore into a real business machine.

Smith-Corona TP-2..... \$995

Top quality US-made daisy wheel printer with both serial and parallel ports. Hosts of features. To suit all computers (Cables extra).

Commodore, Smith-Corona, VIC-20, Automodem, Datasette, Rabbit, Arrow, Apple, TRS-80, Telstar are Registered Trade Marks.

Chambers Computer Supplies
(03) 700 2451
 48-50 MONKHOUSE DRIVE,
 ENDEAVOUR HILLS, MELBOURNE 3802

Loflorien Software

Cultivating New Concepts
**COMPUTER SOFTWARE
SPECIALISTS**



EDUCATION

FRENCH & GERMAN TUTORS
SPELLING & SPEED READING
AUSTRALIAN GEOGRAPHY
THE UNIVERSAL TUTOR
SCHOOL RECORDS & REPORTS

ADMIN. & FILING

ARCHIVE—BIBLIOGRAPHY—FILING
THE LIBRARY CATALOGUE
THE LIBRARIAN'S ASSISTANT
— Loan System —

GAMES

THE CAVERNS OF MORDIA

G.P.O. BOX 1033, SYDNEY 2001
Telephone: (02) 398 4023

How can we tell you about 100
computer games in one advertisement?

**Strategy,
Science Fiction,
Fantasy,
Adventure,
Education,
Sports & Arcade**

**APPLE II
TRS 80
VIC 20
COM 64
ATARI 4/800
IBM PC
PET**

GAMES for the HOME COMPUTER

- Avalon Hill's Micro Computer Games
- EPYX (Automated Simulation)
- Strategic Simulations • MORE!

Mail Order Specialists

Write today for free catalogue
COMPARE OUR PRICES . . .

COMPUTER SIMULATIONS

134 COCHRANES ROAD, MOORABBIN, VIC 3189

PHONE: (03) 555 8886

DEALER ENQUIRIES WELCOME

PROGRAMS

```

1880 IF Tot%(1)=Tot%(2) THEN A$="IT S A DRAW"
1890 COLOUR15:PRINT A$:COLOUR?
1900 ENDFROC
1910
1920 DEFPROCabandon
1930 PRINT"GAME ABANDONED"
1940 PRINT "SCORE:You=":Tot%(1):" Me=":Tot%(2)
1950 ENDFROC
1960
1970 DEFPROCass
1980 DIM Z% 60
1990 FOR I%=0 TO 2 STEP 2
2000 P%=Z%
2010 LUPT I%
2020 .BEST LDX #100
2030 STX Tot
2040 LDX #23
2050 .LOOP1 LDA Tab1,X
2060 DEX
2070 .LOOP2 PHA
2080 CLC
2090 ADC Temp
2100 TAY
2110 LDA Board,Y
2120 BMI AGAIN
2130 CLC
2140 ADC Tab1,X
2150 TAY
2160 LDA Tab2,Y
2170 ADC Tot
2180 STA Tot
2190 .AGAIN PLA
2200 BMI TRISH
2210 EOR #255
2220 ADC #1
2230 BNE LOOP2
2240 .TRISH DEX
2250 BPL LOOP1
2260 LDY Temp
2270 LDA Board,Y
2280 TAY
2290 LDA Tab2,y
2300 CLC
2310 ADC Tot
2320 STA Tot
2330 RTS:1
2340 NEXT
2350 ENDFROC
2360
2370 DEFPROCrules.
2380 REPEAT
2390 CLS:RESTORE
2400 VDU141:PRINTTAB(16)"SPLASH!"
2410 VDU141:PRINTTAB(16)"SPLASH!"
2420 PRINT "SPLASH! is a brand new board game for"
2430 PRINT"two players.It is played on a 7 by 7"
2440 PRINT"board and the object of the game is to"
2450 PRINT"capture more squares than the opponent."
2460 PRINT"Thus,the first player to capture 25 or"
2470 PRINT"more squares is the winner."
2480 PRINT "We take it in turns to play in any free"
2490 PRINT"(ie uncaptured) square : playing in a"
2500 PRINT"square affects those surrounding it."
2510 PRINT "Initially,all squares are black.As the"
2520 PRINT"game progresses they change colour"
2530 PRINT"according to the scheme:"
2540 REPEAT:READ X%:VDU X%:UNTIL X%=99
2550 PRINT "If a square is left white at the end of"
2560 PRINT"a move,it is captured and initialled"
2570 PRINT"(Y=you M=me) by the moving player."
2580 PRINT TAB(7)CHR$(136)"PRESS SPACE TO CONTINUE";
2590 REPEAT:X%=RND(7):UNTIL GET#=" "
2600 CLS
2610 PRINT"Playing in a square increases its colour":
2620 PRINT"by 3 steps (the sequence of colours is"
2630 PRINT"given by the side of the board to help"
2640 PRINT"you I don't need it!).The (8) squares"
2650 PRINT"immediately around it have their colours":
2660 PRINT"increased by 2 steps and the (16) cells"
2670 PRINT"around those are increased by 1 step."
2680 PRINT "Any white cells left at the end of the"
2690 PRINT"move are captured and cannot be affected":
2700 PRINT"by further plays."
2710 PRINT "Being a machine,albeit a clever one,my"
2720 PRINT"patience is almost inexhaustible and if"

```

PROGRAMS

```

2730 PRINT"a stalemate situation occurs (which is"
2740 PRINT"very unlikely) I will not surrender the"
2750 PRINT"game-the onus is on you to do that."
2760 PRINT""If you wish to quit the game at any"
2770 PRINT"time,press Q when asked "Letter?"
2780 PRINT"" Good luck - you'll need it !!!"
2790 PROCyorn(CHR$(129)+"WANT TO READ THE RULES AGAIN? (Y/N)")
2800 UNTIL No
2810 ENDPROC
2820
2830 DEFPROCyorn(A#)
2840 *FX15,1
2850 PRINT A#
2860 REPEAT:A#=GET#
2870 UNTIL A#="Y" OR A#="N"
2880 Yes=(A#="Y"):No=(A#="N")
2890 ENDPROC
2900
2910 DATA 134,221,32,145,47,32,134,221,32,146,47,32,134
2920 DATA 221,32,147,47,32,134,221,32,148,47,32,134,221
2930 DATA 32,151,47,32,134,221,32,145,47,135,101,116,99
2940
2950 DATA 16,1,8,2,8,9,16,10,16,11,16,12
2960 DATA 8,13,8,20,8,21,8,22,8,23,8,24
2970
2980 REM ** NORMAL WEIGHTS **
2990 DATA -1,-1,5,2,1,0,0,0
3000 DATA 0,-1,-3,0,7,0,0,0
3010 DATA -2,-3,-2,6,2,0,0,0
3020
3030 REM ** WEIGHTS FOR DEFENSIVE ENDGAME **
3040 DATA -1,-2,7,4,-6,0,0,0
3050 DATA 0,-6,4,1,6,0,0,0
3060 DATA -5,-3,4,7,2,0,0,0
    
```

ATARI PRINTERS

At last its been done.
Quality JP80 printer with Friction/Tractor feed, 88 CPS, Lower case etc — all the wanted features.
Now running on Atari 400, 600, and 800. Connecting via: games port.

\$498.00

inc interface all cables etc

DATA PARTS

BALLARAT (053) 313 399
BENDIGO (054) 434 866
SHEPPARTON (058) 217 155
ALBURY (060) 218 080



NEW GENERATION COMPUTER STORE PTY. LIMITED

Authorised

digital

Dealer

229 BURNS BAY ROAD, LANE COVE 2066
TELEPHONE: (02) 427 4781, 427 4780

COMPUTER SALES AND SERVICE

COMPUTERS for HOME, INDUSTRY, LABORATORY, OFFICE, EDUCATION

- ★ FORECASTING
- ★ STOCK EVALUATION
- ★ WORD PROCESSING
- ★ ACCOUNTS PAYABLE
- ★ FINANCIAL MODELLING
- ★ DATA BASE APPLICATIONS
- ★ SALES ANALYSIS
- ★ FREE ADVICE ON THE CHOICE OF YOUR SYSTEM
- ★ HUGE RANGE OF SOFTWARE TO CHOOSE FROM
- ★ FRIENDLY ATMOSPHERE
- ★ ATTRACTIVE PRICES
- ★ FINANCIAL MANAGEMENT
- ★ OTHER ACCOUNTING FUNCTIONS
- ★ PERSONAL ASSET MANAGEMENT
- ★ CHARTS, GRAPHS OR PLOTS
- ★ TAX PLANNING
- ★ STATISTICAL ANALYSIS
- ★ EXTENDED HOURS

WE ALSO CARRY AN EXTENSIVE RANGE OF PRINTERS, MONITORS, DISK DRIVES AND OTHER PERIPHERALS TO SUIT ALL MICROCOMPUTERS
??? CHECK US OUT FOR YOUR **SPECIAL PRICE** ???

We offer specialised packages to:
*** Accountants *** Doctors *** Engineers *** Scientists *** Managers ***
Analysts *** Solicitors *** Financial Brokers *** Teachers *** Dentists.

MICRO COMPUTER SALE

APPLE COMPATIBLE COMPUTERS

48K \$449
64K Dual processor, function keys,
etc, from \$549
Disk Drive (Slim, 163K,
super quiet) \$300
Complete Starter System \$1089
Business or Accounting Package
Deal available **Special Offer**
Software support to suit your
requirements
IBM PC compatible computer
complete system \$3600
Phone **560 3293** all hours

MEDIA COPYING SERVICE

- ★ Copying from and to approx 100 different formats
- ★ Quick Turnaround and While-U-Wait service
- ★ Reasonable Rates

Telephone: (03) 772 0781
(03) 772 9177

PROGRAMS



Invaders

by Caspian Prince

You have to guide your homing device in on a wayward alien, floating around in deep space, and then blow it up. Your time is limited, so you will have to move

fast. The game requires a 3k (or switch able 3k, 8k and 16k) memory expansion module and runs on a VIC-20.

Some strange symbols appear in the listing — these are explained in the table below:

KEY TO VIC LISTINGS

{CU}	CURSOR UP	{SS}	SHIFTED SPACE	{BL}	BLUE
{CD}	CURSOR DOWN	{SU}	SHIFT TO UPPER CASE	{YL}	YELLOW
{CL}	CURSOR LEFT	{SL}	SHIFT TO LOWER CASE	{OR}	ORANGE
{CR}	CURSOR RIGHT	{??}	UNDEFINED CHARACTER	{BR}	BROWN
{HM}	CURSOR HOME			{LR}	LIGHT RED
{SC}	CLEAR SCREEN	{BK}	BLACK	{LB}	LIGHT BLUE
		{WH}	WHITE	{LG}	LIGHT GREEN
{RV}	REVERSE ON	{RD}	RED	{G1}	GREY 1
{RO}	REVERSE OFF	{CY}	CYAN	{G2}	GREY 2
{IN}	INSERT	{PU}	PURPLE	{G3}	GREY 3
{DL}	DELETE	{GR}	GREEN		

```

0 CLR:RESTORE:GOSUB10000
1 MZ=13:MX=1
2 DIM E(1,MZ),D(4):REM JEM**SUPER INVADERS**
5 GOSUB 1000:FORI=1TO4:READD(I):NEXT
7 PRINT"[SC]{WH}";
8 GOSUB 300
9 POKE36879,8:POKE650,255:POKE36878,15:TI$="000000"
:GOSUB400
10 FOR I = 1 TO MX
11 IF MX=13 THEN 1100
12 PRINT"[HM]{SC}:"SC"[CR]{CR}{CR}{CR}{CR}TI:"INT(TI/60)
15 IF VAL(TI$)>30+(MX*7)THEN 1200
17 IFNG=1THENNG=0:GOSUB900:GOSUB1000:GOTO9
20 IF E(0,I)=0 THEN GOSUB 1000
30 GETAS
35 IFPEEK(198)>2THENPOKE198,2
40 IF AS<>" " THEN GOSUB 200
88 M=0
89 GOSUB300
90 NEXT I
99 GOTO 10
100 REM MOVE INVADERS
105 GOSUB 600
110 ON INT(RND(1)*4)+1GOTO 120,125,130,135
120 E(1,I)=E(1,I)+22:GOTO140
125 E(1,I)=E(1,I)-22:GOTO150
130 E(1,I)=E(1,I)-1:GOTO150
135 E(1,I)=E(1,I)+1:GOTO140
140 IF E(1,I)<7724 THEN E(1,I)=E(1,I)+22
150 IF E(1,I)>8185 THEN E(1,I)=E(1,I)-22
155 POKE36874,128+I*10
160 GOSUB 700
180 POKE36874,0
199 RETURN
200 REM GET COMMAND
210 IF AS=CHRS(13) THEN GOSUB 500
220 IF AS="Y"THEN M=-22:GOTO 280
230 IF AS="B"THEN M=+22:GOTO 280
240 IF AS="G"THEN M=-1 :GOTO 280
250 IF AS="H"THEN M=+1 :GOTO 280
260 GOTO 299
280 GOSUB 300
299 RETURN
300 REM MOVE CROSS
310 POKEY,32
320 Y=Y+M
330 POKEY,86
399 RETURN
400 REM DO COLORS
402 PRINT"[SC]";:FORI=1TO10
403 PRINT"[HM]";:SPC(I);"[CL] WAIT A MO.."
404 FORPP=0TO50:NEXT:NEXT:PRINT"[SC]";
405 POKE36876,0
410 FOR I = 1 TO 4
420 FOR J= 0 TO 110
430 POKE 38400+110*I+J,I+1
440 NEXT:NEXT
499 RETURN
500 REM SHOOT
510 F1=Y-126 :F2=Y-138
520 F3=Y+126 : F4=Y+138
530 FOR K = 1 TO 6
540 POKE F1,32:POKEF2,32:POKEF3,32:POKEF4,32
550 POKE36876,200-K*4
554 REM
555 REM
558 REM
559 F1=F1+21:F2=F2+23:F3=F3-21:F4=F4-23
560 POKE F1,78:POKEF2,77:POKEF3,78:POKEF4,77
570 NEXT:POKE36876,0
580 FOR J= 1 TO MX
582 IF E(0,J)<>0 THEN 586
584 IF E(1,J)=YTHEN GOSUB 800
586 NEXT:POKE36876,128+K*5:IFNG=1THENS=SC+100
590 POKEF1,32:POKEF2,32:POKEF3,32:POKEF4,32
595 POKE36876,0
599 RETURN
600 REM BLANK OUT
610 POKEE(1,I),32
620 POKEE(1,I)-1,32
630 POKEE(1,I)+1,32
699 RETURN
700 REM DRAW INVADER
710 POKEE(1,I),81
720 POKEE(1,I)-1,60
730 POKEE(1,I)+1,62
799 RETURN
800 REM HIT SHIPS
810 E(0,J)=1
820 POKE36877,200:FORJK=1TO30
830 POKEE(1,J),42:POKEE(1,J)-1,42:POKEE(1,J)+1,42
832 NEXT:POKE36877,0
835 POKEE(1,J),32:POKEE(1,J)-1,32:POKEE(1,J)+1,32
840 SC=SC+PEEK(Y+30720)*2
850 REM
860 FORW=1TOMX
870 IFE(0,W)=1THENBN=BN+1
880 NEXT
890 IFBN=>MXTHENNG=1
895 BN=0
899 RETURN
900 REM NEW GAME
910 FORP=1TO1000:NEXT
915 IFMX=12THENGOSUB1300:GOSUB1400:GOTO1100
920 PRINT"[SC]{WH}{CD}{CD}{CD}{CR}{CR}YOU MADE IT!"
930 PRINT"[CD]{CR}{CR}BUT IT'S GONNA"

```

PROGRAMS

```
940 PRINT"(CD){CR}{CR}GET HARDER NOW!!"
950 MX=MX+1
960 PRINT"(GR){CD}NOW THERE'S"MX"FIGHTERS!!"
970 FORP=1TO5000:NEXT
980 TIS="000000"
999 RETURN
1000 REM INIT INV
1010 FOR I = 1 TO MX
1020 E(1,I)=7680+INT(RND(1)*400)+22:E(0,I)=0
1030 NEXT
1050 Y=7910
1055 PRINT"(SC)"
1099 RETURN
1100 PRINT"(SC){CD}{CD}{CD}{CD}{CR}{CR}{CR}{CR}{GR}YOU CLEARED"
1110 PRINT"(CD){CR}{CR}{CR}{CR}{CR}{CR}THE GALAXY OF"
1115 PRINT"(CD){CR}{CR}{CR}{CR}{CR}{CR}ALL THE ALIENS"
1120 PRINT"(CD){CR}{CR}{CR}{CR}{CR}{CR}FOR THIS, YOU"
1130 PRINT"(CD){CR}{CR}{CR}{CR}{CR}{CR}WILL HAVE YOUR"
1137 PRINT"(CD){CR}{CR}{CR}{CR}{CR}{CR}SCORE MULTIPLIED"
1138 PRINT"(CD){CR}{CR}{CR}{CR}{CR}{CR}BY 12 WHICH"
1140 PRINT"(CD){CR}{CR}{CR}{CR}{CR}{CR}MAKES"SC*12:SC=SC*12
1150 PRINT"(CD){CD}{CR}{CR}{WH}THANKS FOR PLAYING";
1160 GOTO1299
1200 PRINT"(HM){YL}OVERRUNOVERRUNOVERRUN!"
1210 PRINT"(HM){CD}{CD}{CD}{CD}{CD}{CD}{CD}{CD}{CD}{CD}{CD}{CD}
(CD){CD}{CD}{CD}{CD}{CD}{CD}{YL}OVERRUNOVERRUNOVERRUN":POKE8185,33
1212 FOR I=1 TO 15
1215 POKEY=-22,42:POKEY+22,42:POKEY-1,42:POKEY+1,42
1220 FOR L=1 TO 200:NEXT L
1225 POKEY=-22,32:POKEY+22,32:POKEY-1,32:POKEY+1,32
1227 POKEY=-23,42:POKEY+21,42:POKEY-21,42:POKEY+23,42
1230 FOR L=1 TO 200:NEXT L
1240 POKEY=-23,32:POKEY+21,32:POKEY-21,32:POKEY+23,32
1245 POKE36878,15-I:POKE36877,160-I
1250 NEXT I
1260 POKE36878,0:POKE36877,0
1270 PRINT"(HM){CD}{CD}{CD}{CD}{CD}{CR}{CR}{CR}{CR}{CR}{GR}YOU CLEARED"
1271 PRINT"(CD){CR}{CR}{CR}{CR}{CR}{CR}"MX-1"TWELEFTHS "
1275 PRINT"(CD){CR}{CR}{CR}{CR}{CR}{CR}OF THE GALAXY"
1280 PRINT"(CD){CR}{CR}{CR}{CR}{CR}{CR}SO YOUR SCORE"
1285 PRINT"(CD){CR}{CR}{CR}{CR}{CR}{CR}WILL BE TIMESD"
1287 PRINT"(CD){CR}{CR}{CR}{CR}{CR}{CR}BY"MX"WHICH"
1288 PRINT"(CD){CR}{CR}{CR}{CR}{CR}{CR}MAKES";:SC=SC*MX:PRINTSC;:."
1290 PRINT"(CD){WH}{CR}{CR}THANKS FOR PLAYING"
1299 POKE198,0:FORI=1TO8000:NEXT:PRINT"(SC){BL}";:POKE36879,27:END
1300 FORI=128TO254:POKE36874,I:POKE36875,350-I:POKE36876,I:NEXT:POKE36874,
0:POKE36875,0
1310 POKE36876,0:RETURN
1400 GOSUB1500:D=1:Y=7703:FORI=160TO130STEP-.05
1410 POKE36877,I
1420 POKEY,160:Y=Y+D(D):POKEY,86:IFPEEK(Y+D(D))=160THEND=D+1:IFD>=5THEND=1
1430 NEXT:POKE36877,0:DATA1,22,-1,-22
1499 RETURN
1500 FORI=0TO21
1510 POKE7680+I,160
1520 POKE7701+I*22,160
1530 POKE8185-I,160
1540 POKE8164-I*22,160
1550 NEXT
1560 RETURN
10000 PRINT"(SC)THE KEYS:"PRINT"#####
10001 PRINT"Y-UP"
10002 PRINT"B-DOWN"
10003 PRINT"G-LEFT"
10004 PRINT"H-RIGHT"
10005 PRINT"RETURN-FIRE CANNONS"
10006 PRINT"SHOOT ENEMYS (<Q>) DEAD IN MIDDLE.SCORE DEPENDS ON COLOR."
10007 PRINT"TIME LIMIT:AROUND 35- 130 SECONDS.GOOD LUCK!"
10008 PRINT"(RV)HIT A KEY":WAIT203,191:GETAS:RETURN
READY.
```



Othello by S Rodgers

Reversi is a board game for two players that many people will have heard of. It was first invented in the 1880s by Lewis Waterman. John W Mollett also claims to have been the originator, but Waterman seems to have had his rules published first.

It was re-invented in 1971 by Goro

Hasegawa of Japan who altered the first four positions and renamed it Othello.

The game starts with four pieces placed in the centre of the 8 by 8 board and moves are made by placing your piece next to one of your opponent's. This is only allowed when, by placing your piece, a row is formed with one of

your pieces on either end, your opponent's being in between. You then claim all the pieces by turning them over so that they are your colour. The winner is the player who has the most pieces left when the board is full.

This version from S Rodgers is for two players and makes good use of the Com-

PROGRAMS

1310 If not the first time then miss 1320.

1330-1380 Change every counter in the line, then change the scores.

1380 Set the successful go flag.

1410 Print the player piece in the correct place and update the board array.

1420-1430 Make noise.

1510-1540 Print both the scores.

5010-5020 Change player and move sprite 1.

5030 Record the go in the TU array then reset XX, YY.

6010 Switch off the sprites.

6020-6050 Flash the board colours.

6060 Select ROM characters and select border and background colours.

6130 After CLR, S and V are redefined.

7010 If not the first time then miss changing the screen.

7020-7040 Fresh screen and print message.

7050-7060 Get the position from the TU array and position accordingly.

7070 Rapidly flash the sprites until the appropriate key is hit.

7080 Sprites off.

7100 If the TU array is not empty then:

7110 Switch off the replay flag.

7120 Blank out the message.

8010-8020 Copy characters 8 bytes by 8 bits.

8030 If bits set then 2 bits in X.

8050-8060 Store the left 8 bits of X.

8070-8080 Store the right 8 bits of X.

8090 Move 4 characters along, avoid redefining spaces or quotes.

9010-9020 Reset the board array.

9030 Select colours and clear the screen.

9040 Print 64 cells depending on the contents of the board array.

9050-9070 Print the score and the player pieces.

9080 Set scores position. Blue starts.

9082 Print the scores.

58010 Set V, S. Set colours. Clear the screen to Cyan.

```

1290 GOTO1010
1299 :
1300 REM **** UPDATE BOARD SCORES ****
1310 IFF1 THEN1330
1320 Y=YY:X=XX:SC(PL)=SC(PL)+1:BO(X,Y)=PL:GOSUB1410
1330 FORJ=1T08:IFBO(X+J*DX,YY+J*DY)=PL THENJ=8:GOTO1380
1340 IFPL=1 THENSC(2)=SC(2)-1:GOTO1360
1350 SC(1)=SC(1)-1
1360 SC(PL)=SC(PL)+1:GOSUB1510
1370 X=XX+J*DX:Y=YY+J*DY:GOSUB1410
1380 NEXTJ:FL=1:RETURN
1399 :
1400 REM *** PRINT COUNTER NOISE ****
1410 PRINTLEFT$(UD$, (Y-1)*3+1)TAB((X-1)*3)BO$(PL):BO(X,Y)=PL
1420 POKES+5,15:POKES+6,81:POKES+24,15
1430 POKES+4,129:FORI=25T035:POKES+I,I:POKES,I:NEXT:POKES+4,128
1440 RETURN
1499 :
1500 REM **** PRINT SCORES ****
1510 PRINT"          "TAB(32):FORI=1T02
1520 PRINTNO$(INT(SC(I)/10))NO$(SC(I)-INT(SC(I)/10)*10)
1530 PRINT"          "TAB(32)
1540 NEXT:RETURN
1599 :
5000 REM **** CHANGE PLAYERS ****
5010 IFF1=1 THENPI=2:POKEV+3,125:GOTO5030
5020 PL=1:POKEV+3,83
5030 TU(0,TU)=XX:TU(1,TU)=YY:TU=TU+1:XX=1:YY=1:GOTO1010
5999 :
6000 REM **** END OF GAME ****
6010 POKEV+21,0
6020 FORI=1T050
6030 POKEV+35,6:FORJ=0T050:NEXT
6040 POKEV+35,14:FORI=1T050:NEXT
6050 NEXT
6060 POKEV+24,21:POKEV+33,0:POKEV+32,0:PRINT"          "
6070 PRINTSPC(14)"*****"
6080 PRINTSPC(14)"* GAME OVER *"
6090 PRINTSPC(14)"*****"
6100 PRINT"          "PLAYER ONE (BLUE) SCORED"SC(1)
6110 PRINT"          "PLAYER TWO (WHITE) SCORED"SC(2)
6120 PRINTSPC(14)"          PLAY AGAIN?"
6130 CLR:S=54272:V=53248:GOTO30
6999 :
7000 REM **** COMPUTER REPLAY ****
7010 IFTU(0) THEN7050
7020 GOSUB9000
7030 PRINT"          "LEFT$(UD$,18)TAB(29)CH$(5)CH$(6)CH$(4)
7040 PRINT"          "TAB(27)CH$(7)"          "CH$(2)CH$(3)"          "CH$(6)
7050 XX=TU(0,TU):YY=TU(1,TU)
7060 POKEV,26+24*(XX-1):POKEV+1,50+24*(YY-1)
7070 POKEV+21,3:GETR$:IFR$<"E"ANDR$>"E" THENPOKEV+21,0:GOTO7070
7080 POKEV+21,0
7090 IFR$="E" THEN7110
7100 IFTU(0,TU+1)<0 THEN1200
7110 FF=0
7120 PRINTLEFT$(UD$,17):FORI=0T04:PRINTTAB(27)"          ".NEXT
7130 GOTO1010
7999 :
8000 REM **** COPY CHARACTERS ****
8010 FORBY=0T07:X=0
8020 FORBI=0T07
8030 IF(PEEK(53248+CH*8+BY)AND2161) THENX=X+2+(BI*2)+2+(BI*2+1)
8040 NEXTBI
8050 POKEA+BY*2,X/256
8060 POKEA+BY*2+1,X/256
8070 POKEA+16+BY*2,X-(INT(X/256)*256)
8080 POKEA+16+BY*2+1,X-(INT(X/256)*256)
8090 NEXTBY:A=A+32:IFA=14576 THENA=A+40
8100 RETURN
8999 :
9000 REM **** FRESH BOARD ****
9010 FORI=1T08:FORJ=1T08:BO(I,J)=0:NEXTI,J
9020 BO(4,4)=2:BO(5,5)=2:BO(4,5)=1:BO(5,4)=1
9030 POKEV+33,14:POKEV+32,14:PRINT"          "
9040 FORI=1T08:FORJ=1T08:PRINTBO$(BO(I,J)):NEXT:PRINT"          ":NEXT
9050 PRINT"          "TAB(27):FORI=0T04:PRINTCH$(I):NEXT:PRINT
9060 PRINT"          "TAB(27)BO$(1)
9070 PRINT"          "TAB(27)BO$(2)
9080 SC(1)=2:SC(2)=2:XX=1:YY=1:PL=1:TU=1
9082 GOSUB1510
9090 RETURN
9999 :
58000 REM **** LOGO ****

```

THE DROUGHT HAS BROKEN

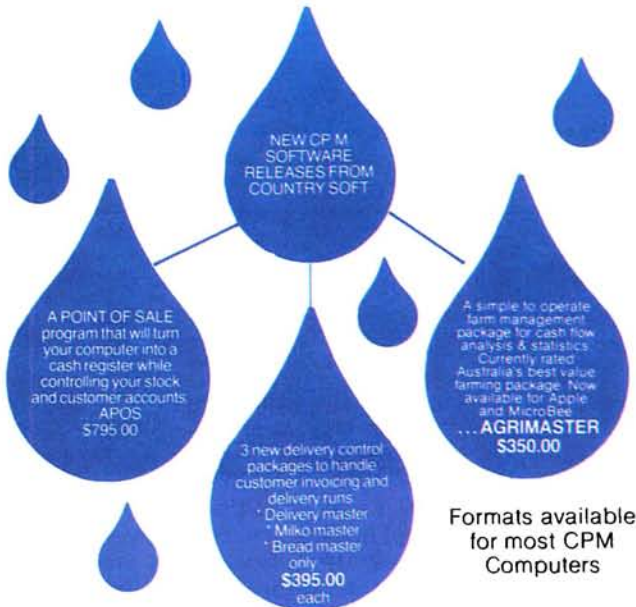

Formats available for most CP/M Computers

PLUS:

CASHBOOK 2.0 – Cashbook Accounting Programme with Cheque Writer only **\$300.**

INFO MANAGE 1.4 – Easy to use powerful new Data Base only **\$279.00**

Available from:

Country Soft Pty Ltd

U6/62 Burswood Road, Victoria Park, W.A. 6100
Phone: (09) 362 6416

SCHIZOPHRENIA?

Well two minds are better than one!

Let us introduce you to the **MICRO 64**. Share the fun of Applesoft and the power of CP/M in a computer which allows you to control its TWO on board processors, the Z80A and the 6502.

Built-in quality from the motherboard to the professional keyboard ensure your complete control over this clever performer.

... and besides the quality feel the price... at \$669 tax paid, can you afford not to think twice about going elsewhere? Join our user group after you've said "Hello, Hello" to the bi-brained MICRO 64.

You might also like to meet it's single-minded friends in printers, disk drives and supplies.

If you can't afford our prices, you can't afford to go elsewhere.

Special mail offer — diskettes

QUALITY GUARANTEED DATALIFE VERBATIM
Mailed free anywhere in Australia. Tax included

5 1/4" Single-sided, Double-density	\$35.00
5 1/4" Double-sided, Double-density	\$46.00
8" Single-sided, Double-density	\$50.00
8" Double-sided, Double-density	\$54.00

38 WARATAK St, OATLEY, 2223
TELEPHONE: (02) 570-5197
TELEX: PUBTLX AA 21822 USER Nr SY827

Last Word

NO.1 GAME OF THE YEAR

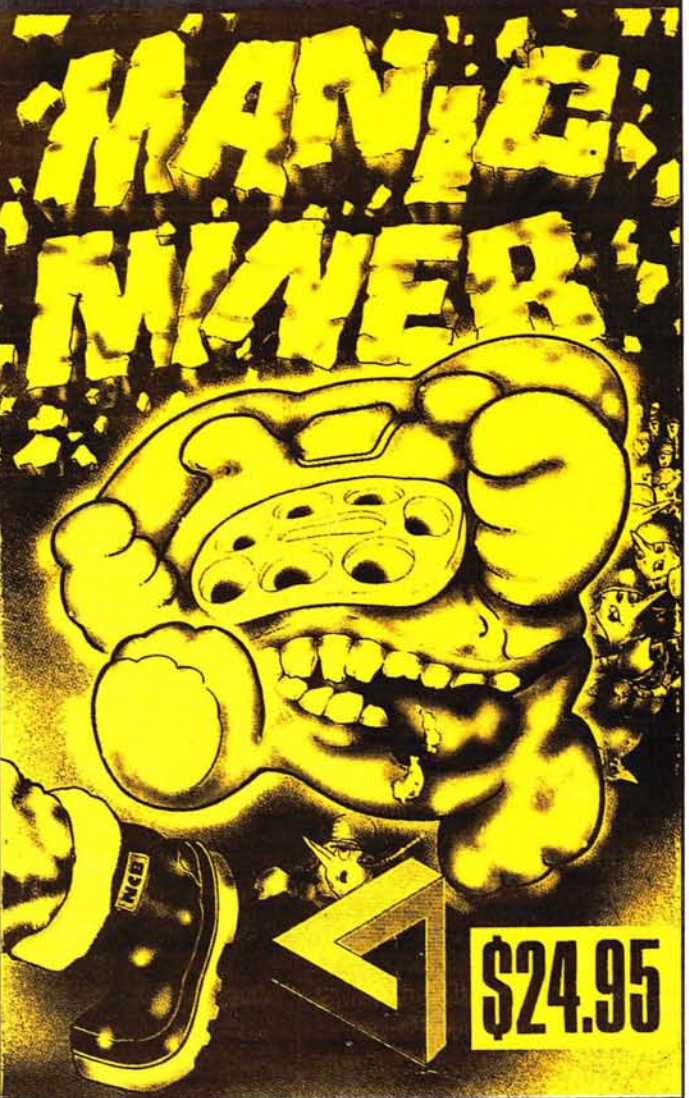

Spectrum 48k - Commodore 64

A.P.C. SCREENPLAY REVIEW, FEB. 1984.

"MANIC MINER™ is a must..... it has justifiably won the Game of the Year Award in the U.K."★★★★★

SOLE AUSTRALIAN DISTRIBUTORS

COMPUTERPLAY — SOFTWARE
YOUR SOURCE OF SOFTWARE

P.O. Box 69, Glen Waverley, 3150
Phone: (03) 561 1078

For Best Results Use A



SUPER CHAMP

12 MONTHS GUARANTEE
10ft RETRACTABLE CABLE



DEALER & DISTRIBUTOR ENQUIRIES WELCOME

PROGRAMS

60202 DATA0,15,240,0,63,0,0,60,1378
 60203 DATA0,0,240,42,160,240,42,128,1852
 60204 DATA240,42,0,240,0,0,240,0,1762
 60205 DATA0,240,0,0,240,21,0,240,1741
 60206 DATA21,64,240,21,80,252,21,80,1779
 60207 DATA60,0,0,63,0,0,15,240,1378
 60208 DATA0,3,252,0,0,12,0,1267,-1



Moon Lander

by A Alley

This program is an arcade-type game for the VZ-200, and is fashioned after the video game of the same name. The aim is to land as many times as possible on the red landing pads provided without running out of fuel or crashing into the rocky landscape. The keys Y, G, and H are used to control the various motions of the ship.

The main outline of the program is as follows:

Line numbers 90 to 140 clear the preceding screen.

Line numbers 220 to 445 draw the

landscape and landing pad.

Line numbers 500 to 620 handle actual game play.

Line numbers 1000 to 1260 detect landings and crashes and take the appropriate course.

Line numbers 1400 to 1420 draw the ship.

Line numbers 1900 to 2020 are the subroutine to display the score, number of ships remaining and so on.

Line numbers 3000 to 3190 are instructions.

Care should be taken when piloting the space ship as it will drift after being moved in any direction. At the end of each successful mission, bonus points will be added to the score. It should be kept in mind that a player need not land on each landscape; he may simply thrust upwards to the top of the screen and another landscape will be drawn up. An extra ship will be awarded at each 100 points.

```

5 REM: ***MOON LANDER*** BY ANDREW ALLEY
7 REM: 13 FEBRUARY, 1984
10 CLS:PRINT@198,"***MOON LANDER***"
20 PRINT@264,"BY ANDREW ALLEY"
30 PRINT:PRINT:PRINT:INPUT"INSTRUCTIONS":A$:IFA$="Y",3000
90 CLEAR$:DIMB(254):MODE(1):SO=28671:SU=3:GOTO220
100 IFDO<>OTHERS1=S1+INT(FU/5):GOSUB1900
105 COLOR3:FORX=2TO253:SET(X/2,B(X)):NEXT
110 FORX=0TO24:SET((Q+X)/2,R):SET((Q+X)/2,R+1):NEXT
120 FORY=-1(Q)TOR-1STEP$GN(R-1-B(Q)):SET(Q/2,Y):NEXT
130 FORY=B(Q+24)TOR-1STEP$GN(R-1-B(Q+24)):SET((Q+24)/2,Y):NEXT
140 A=0:B=0:DO=0:COLOR2:GOTO340
220 FORX=28672TO30719:POKEX,170:NEXT
230 FORT=30511TO30639STEP32:READU:POKET,U:NEXT
250 FORT=0TO9:FORU=0TO4:READSC(T,U):NEXT:NEXT:COLOR2:GOSUB2000
340 Y=RND(18)+32:FORX=2TO253:Y=Y+RND(3)-2:IFY<20,Y=20
350 IFY>50,Y=50
360 B(X)=Y:SET(X/2,B(X)):NEXT
380 Q=RND(230):R=B(Q)+5:FORX=0TO24:COLOR3
390 SET((Q+X)/2,B(Q+X)):COLOR4:SET((Q+X)/2,R):SET((Q+X)/2,R+1)
395 NEXT
400 COLOR2:FORY=B(Q)TOR-1STEP$GN(R-1-B(Q)):SET(Q/2,Y):NEXT
410 FORY=B(Q+24)TOR-1STEP$GN(R-1-B(Q)):SET(Q/2,Y):NEXT
420 FORY=0TO63:RESET(0,Y):RESET(127,Y):NEXT
445 COLOR4:FORT=68TO102:SET(T,60):NEXT
500 X=28944:FU=35
520 LT=164:RT=26:BL=106:BR=169:P$=INKEY$
530 IFP$="Y"ANDFU>0,A=A-32:BL=107:BR=233ELSEA=A+32:GOTO550
540 FU=FU-1:POKESO,10:POKESO,11:IFA<-96,A=-96
550 IFA>96,A=96
555 IFP$="G"ANDFU>0,B=B-.2:RT=31:POKESO,10:POKESO,11ELSE570
560 FU=FU-.5:IFE<-1,B=-1
    
```

PROGRAMS

```

570 IFP$="H"ANDFU>0,B=B+.2:LT=244:POKESO,10:POKESO,11ELSE585
580 FU=FU-.5:IFR>1,B=1
585 FORX1=XTOX+128STEP32:POKEX1,170:POKEX1+1,170:NEXT
590 X=X+A+B:FOR X1=XTOX+128STEP32
600 IFPEEK(X1)<>170ORPEEK(X1+1)<>170,1000
610 NEXT:IFX<28800,100
620 GOSUB1400:RESET(FU+68,60):GOTO520
1000 IFPEEK(X1)<>255ORPEEK(X1+1)<>255,1050
1005 IFA>64,1050
1010 DO=DO+1:IFDO<>1,1040
1012 IFPEEK(X+128)<>170ORPEEK(X+129)<>170,X=X-32:GOTO1012
1020 GOSUB1400:POKEX+1,74:POKEX-31,130:POKEX-63,138
1025 SOUND4,5:SOUND11,5:SOUND16,5:SOUND20,3:SOUND19,6
1027 POKEX-31,170:POKEX-63,170
1030 S1=S1+5:FORX1=XTOX+128STEP32:POKEX1,170:POKEX1+1,170:NEXT
1040 GOSUB1400:IFFU<=0,1100
1045 X=X-32:A=0:B=0:GOTO590
1050 IFPEEK(X1)=42ORPEEK(X1+1)=168,X=X-B:B=0:GOTO590
1100 GOSUB1400:PORT=1TO8:E(T)=X+32+INT(T/4):F(T)=RND(2)*32
1105 G(T)=(T-4)*.1:NEXT
1110 FORT1=1TO12:FORT=1TO8:POKEE(T),170:E(T)=E(T)-F(T)+G(T)
1120 POKEE(T),190:POKESO,10:POKESO,11:NEXT:NEXT
1125 FORT=1TO8:POKESO,10:POKESO,11:FORT1=1TO15:NEXT:NEXT
1220 FORT1=XTOX+128STEP32:POKEX1,170:POKEX1+1,170:NEXT
1230 FORT=1TO8:POKEE(T),170:NEXT:SU=SU-1
1250 IFSU =0,GOSUB1900:FORT=1TO2000:NEXTELSE1260
1252 PRINT"236,"GAME OVER":PRINT:PRINT"SCORE";S1+2*10+S3*100
1255 SOUND12,3:PRINT:INPUT"ANOTHER GAME";A$:IFA$="Y",RUNELSEEND
1260 GOSUB1900:GOTO100
1400 POKEX,165:POKEX+1,90:POKEX+32,144:POKEX+33,6:POKEX+64,11
1410 POKEX+65,RT:POKEX+96,152:POKEX+97,38:POKEX+128,BL
1420 POKEX+129,BR:RETURN
1900 IFS1>0,S1=S1-10:S2=S2+1:GOTO1900
1910 IFS2>0,S2=S2-10:S3=S3+1:SU=SU+1:GOTO1910
1920 IFS3>0,S3=S3-10:GOTO1920
2000 I=-1:FORH=30500TO30628STEP32:I=I+1:POKEH,SC(S3,I)
2010 POKEH+1,SC(S2,I):POKEH+2,SC(S1,I)
2020 POKEH+5,SC(SU,I):NEXT:RETURN
2405 DATA2,42,10,42,42,86,102,102,102,86,154,90,154
2500 DATA154,86,86,166,86,106,86,86,166,150,166,86,102,102,86
2505 DATA166,166,86,106,86,166,86,86,106,86,102,86,86,102,166
2510 DATA166,166,86,102,86,102,86,86,102,86,166,166
3000 CLS:PRINTTAB(0)"*MOON LANDING*"
3020 PRINT:PRINT"PILOT A SPACE MODULE ONTO THE"
3030 PRINT" SURFACE OF THE MOON.":PRINT
3040 PRINT"YOU MUST LAND ON THE LANDING PAD"
3050 PRINT" THE CRAFT WILL DRIFT WHEN YOU"
3070 PRINT" THRUST IN ANY DIRECTION.":PRINT
3080 PRINT"YOU ARE AWARDED AN EXTRA MODULE"
3085 PRINT" UPON REACHING EACH 100 POINTS":PRINT
3090 PRINT" WATCH YOUR FUEL!":PRINT
3095 PRINTTAB(8)"PRESS ANY KEY";
3100 FORT=1TO10:A$=THEKEY$:NEXT
3110 IFFUEV$="",3110
3115 CLS:PRINTTAB(0)"*MOON LANDING*"

```

PROGRAMS

```

3120 PRINT:PRINT"CONTROLS:":PRINT
3130 PRINT" *Z* .....MAIN THRUSTER":PRINT
3140 PRINT" *Z* ....LEFT AUX. THRUSTER":PRINT
3150 PRINT" *Z* ...RIGHT AUX. THRUSTER":PRINT
3155 PRINT" BONUS POINTS AWARDED FOR FUEL REMAINING.":PRINT
3160 PRINTTAB(11)"000/0000!"
3170 PRINT:PRINTTAB(0)"PRESS ANY KEY";
3180 FOR T=1 TO 10:A$=INKEY$:NEXT
3190 IF INKEY$="" ,3180 ELSE 90
    
```



Gary the Guitar

by J Springall

This program for the CBM 64 takes you to a crazy world of music. You take the part of Gary the Guitar, the one in the top left hand corner of the screen, wearing the sunglasses.

Your aim is to try and reach your friend at the bottom right-hand corner of the screen. The drawback is that you have to

get past the notes that are drifting along the staff (the lines drawn across the screen).

The only way to get past these notes is to jump over them, this is done by pressing the space bar or, if you're using a joystick, the fire button. Be careful how you go, since it is possible to bump into

the notes on the line above, as well as those in front. You can move forwards and backwards while you are in the air, so you can avoid the notes while you are in mid leap. One other thing to be careful of is the different speeds of the notes. The further you get down the screen, the harder it is.

- 1 Set up variables and pointer to the sprite registers (V). The last poke sets the volume of all voices to maximum.
- 2 Clear the screen and set the foreground and background colours: GOSUB and print the intro.
- 5 Gosub and print the playing screen.
- 6 Discard the first 15 bits of data.
- 10 Toggle sprites on/off.
- 20 Set up the sprite pointers.
- 30-33 Read sprite data.
- 38-40 Put two of the sprites onto the screen.
- 50 Test the keyboard.
- 60-80 Check for keys to move Gary and move sprites as appropriate.
- 90-107 Jump and check position.
- 110-116 Move the other sprites on the screen.
- 120 Check for position and end if bumped.
- 300-330 Make the sound effects.

```

1 V=53248:F=20:K=1:O=230:S=103:Z=130:H=30:L=60:POKE54296,15
2 PRINT"7" : POKE53281,11:POKE53280,11:GOSUB3000
5 GOSUB 500
6 FORN=0 TO 15:READQ:NEXT
10 POKEV+21,252
20 POKE2042,13:POKE2043,192:POKE2044,191:POKE2045,191:POKE2046,191:POKE2047,191
30 FORN=0 TO 62:READQ:POKE832+H,0:NEXT
31 FORN=0 TO 62:READQ:POKE12282+H,0:NEXT
32 RESTORE:FORN=1 TO 142:READQ:NEXT:FORN=0 TO 62:READQ:POKE12224+H,0:NEXT
33 RESTORE
38 POKEV+41,0:POKEV+42,1:POKEV+43,4:POKEV+44,1
39 POKEV+6,250:POKEV+7,202
40 POKEV+4,F:POKEV+5,S+J
50 GETA$
60 IFA$="M" THEN F=F+6:IFF>230 THEN F=20:J=J+33:IFS+1>235 THEN GOTO 700
70 IFA$="M" AND I>20 THEN F=F-6
80 IFA$=" " AND P=0 THEN P=1
90 IFF=1 THEN J=J-3:K=K+1:IFK=20 THEN P=2
100 IFF=2 THEN J=J+3:K=K+1:IFK=40 THEN P=0:K=0
105 IFF=2 OR P=1 AND K<5 THEN POKE54277,190:POKE54278,248:POKE54273,17
106 IFF=2 OR P=1 AND K<5 THEN POKE54272,37:POKE54275,17:FOR T=1 TO 100:NEXT:POKE54276,0
107 IFF=2 OR P=1 AND K<5 THEN POKE54278,0:POKE54277,0
110 POKEV+8,0:POKEV+9,103:O=O-3:IF O<3 THEN O=230
112 POKEV+10,Z:POKEV+11,166:Z=Z-8:IF Z<3 THEN Z=230
114 POKEV+12,H:POKEV+13,199:H=H-8:IF H<3 THEN H=230
116 POKEV+14,L:POKEV+15,136:L=L-3:IF L<3 THEN L=230
120 II=PEEK(53278):IF II=200 THEN I=132 OR I=360 THEN I=68 THEN 2000
300 POKE54277,9:POKE54276,17:FOR T=1 TO 10:NEXT:READA:READP
310 IFB=-1 THEN POKE54273,0:POKE54272,0:END
320 LI=L+1:POKE54273,A:POKE54272,B:POKE54276,0
322 IFLJ=0 THEN RESTORE:LJ=0
330 DATA 17,37,19,63,21,154,22,227,25,177,28,214,32,94,34,175
335 D=D+1
340 PRINT"*****";D
490 GOTO 400
500 PRINT"7"
502 PRINT"*****"
505 FOR X=0 TO 3
510 PRINT"*****"
520 NEXT
540 PRINT"*****LIVES #5 *****SCORE"
560 RETURN
700 D=D+5000
705 PRINT"*****";D
710 PRINT"*****WELL DONE *****"
720 PRINT"*****DO YOU WANT ANOTHER GO ?"
730 GETD$:IF D$="V" THEN RUN
740 IFD$="N" THEN END
760 GOTO 730
1000 DATA 0,252,0
1001 DATA 0,252,0
1002 DATA 0,120,0
1003 DATA 0,120,0
1004 DATA 0,120,0
1005 DATA 0,120,0
1006 DATA 0,120,0
1007 DATA 0,120,0
1008 DATA 0,120,0
1009 DATA 3,255,0
1010 DATA 4,120,128
1011 DATA 0,120,64
    
```

PROGRAMS

- 335-340 Update and print the score onto the screen.
- 500-560 Print the playing screen.
- 700-750 Well done, option for another game etc.
- 1000-1220 Sprite data.
- 2000-2036 Lose a life, make crash sound and continue.
- 3000-3100 Opening intro display, press S to start the game.

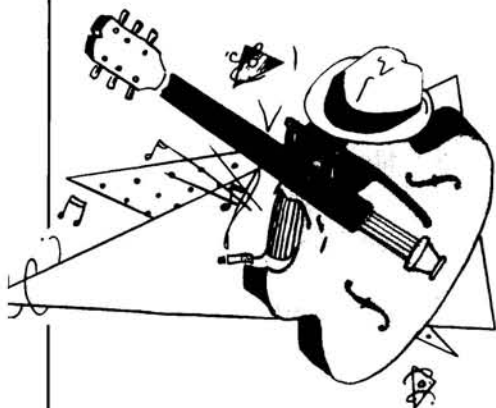

```

1012 DATA 8 , 0 , 64
1013 DATA 5 , 206 , 128
1014 DATA 5 , 206 , 128
1015 DATA 9,206,64
1016 DATA 8,132,64
1017 DATA 16 , 48 , 32
1018 DATA 16 , 132 , 32
1019 DATA 8 , 120 , 64
1020 DATA 7 , 255 , 128
1100 DATA 0 , 0 , 0
1101 DATA 0 , 0 , 0
1102 DATA 12 , 0 , 0
1103 DATA 18 , 56 , 0
1104 DATA 33 , 68 , 0
1105 DATA 64 , 130 , 0
1106 DATA 128 , 1 , 0
1107 DATA 128 , 1 , 0
1108 DATA 136 , 225 , 7
1109 DATA 233 , 247 , 255
1110 DATA 233 , 247 , 255
1111 DATA 136 , 225 , 7
1112 DATA 128 , 1 , 0
1113 DATA 128 , 1 , 0
1114 DATA 64 , 130 , 0
1115 DATA 33 , 68 , 0
1116 DATA 18 , 56 , 0
1117 DATA 12 , 0 , 0
1118 DATA 0 , 0 , 0
1119 DATA 0 , 0 , 0
1120 DATA 0 , 0 , 0
1200 DATA 0 , 0 , 112
1201 DATA 0 , 0 , 127
1202 DATA 0 , 0 , 110
1203 DATA 0 , 0 , 96
1204 DATA 0 , 0 , 96
1205 DATA 0 , 0 , 96
1206 DATA 0 , 0 , 96
1207 DATA 0 , 0 , 96
1208 DATA 0 , 255 , 96
1209 DATA 1 , 255 , 224
1210 DATA 3 , 255 , 224
1211 DATA 7 , 255 , 224
1212 DATA 7 , 255 , 224
1213 DATA 15 , 255 , 224
1214 DATA 15 , 255 , 224

1215 DATA 15 , 255 , 224
1216 DATA 7 , 255 , 224
1217 DATA 7 , 255 , 224
1218 DATA 3 , 255 , 224
1219 DATA 1 , 255 , 128
1220 DATA 0 , 255 , 0
2000 V=54296:H=54276:A=54277
:H=54273:L=54272
2010 FORX=15TO8STEP-1:POKEY,
Y:POKEY,129:POKER,15:POKPH,40
POKEL,200:NEXT
2016 POKEY,0:POKEN,0:POKER,0:
POKEH,0:POKFL,0
2020 POKEW,0:POKER,0
2030 IF KJ=0ANDB=0 THENKJ=52:B=1
2031 IFKJ=52ANDB=0 THENKJ=51:B=1
2032 IFKJ=51ANDB=0 THENKJ=50:B=1
2033 IFKJ=50ANDB=0 THENKJ=49:B=1
2034 IFKJ=49ANDB=0 THEN POKE1070,
49:POKE55342,1:GOTO720
2035 POKE1070,KJ:POKE55342,1:B=0
2036 V=53248:F=20:K=1:O=230:S=103:
7=120:H=30:L=60:POVE54296,15:J=0:P=0
2040 GOTO39
3000 PRINT"*****GARY AT THE GUITAR*****"
3005 PRINT"*****GARY AT THE GUITAR*****"
3010 PRINT"*****GARY AT THE GUITAR*****"
3020 PRINT"YOU ARE A GUITAR CALLED GARY."
3030 PRINT"THE IDEA OF THE GAME IS TO
RESOLVE YOUR"
3035 PRINT"YOUR GIRL FRIEND ANOTHER GUITAR OF COURSE"
3040 PRINT"IN YOUR WAY TO A MUSIC SHEET FULL"
3045 PRINT"OF NOTES , WHICH YOU HAVE TO
JUMP OVER"
3050 PRINT"YOU MOVE BY:-"
3060 PRINT"RIGHT - CRSR (LEFT/RIGHT)"
3070 PRINT"LEFT - CRSP (UP/DOWN)"
3080 PRINT"JUMP - SPACE BAR
BY JEREMY SPOTMALL"
3085 PRINT"***** PRESS S TO START"
3087 PRINT"***** PRESS S TO START"
3090 GET A$:IF A$="S"THENRETURN
3100 FORT=1TO50:NEXT:GOTO3085
    
```

am computer accessories protect
your data and maintain
your computer . . .



RETAIL: BASS COMPUTING, 1258 High Street, Armadale, Vic 03 509 9855
 FLEXICOM, P.O. Box 577, Blackwood, S.A. 08 276 8966
WHOLESALE: D.D.S. P.O. Box 252, Prahran, Vic 3181
DEALER ENQUIRIES WELCOME



BANKS'

Telephones with built-in computers? Martin Banks calls to mind the everchanging world of telecommunications.

Ring in the new

It was heaven over Christmas, it really was.

I loafed around, saw some friends, sang some songs and forewent the pleasure of making my usual, horrendously expensive investment in the joys of Telecom.

It is a time of year, however, when certain advantages do occur. The prime one is that, for once, the telephone stops ringing. For the rest of the year it warbles away bringing news of all sorts of fun events; press conferences to attend, new computers being launched, companies going bankrupt: you know the type of thing. The telephone is, without doubt, one of the most useful items of equipment that technology has ever managed to create.

Unfortunately, that usefulness is leading to its downfall. To be sure, the coming downfall of the telephone is only relative, for it will be a downfall only of what we see and use today. The 'telephones' of tomorrow will be radically different in their capabilities. Just talking will become *passee*.

The humble telephone, already shaken out of its low technology *reverie* by the introduction of such marginally useful gizmos as push-button dialling, memory dialling, last number recall and so on, is at last going to become the basis of the knowledge and information era that everyone has been predicting for it for years. Now, at last, the hardware is beginning to appear.

There will be those that hold up their

hands at this point and say: 'But hardware like that has been around for years,' and I shall say unto them: 'True, but so what?'. It will be in this year, already so loaded with Orwellian 'significance', that at least half of the 'Telescreen' will come onto the market in forms that people can afford.

Certainly machines of this type have been around for some years, in both prototype and in saleable form. The West German company Nixdorf, for example, had a system on display back in the late seventies. Nixdorf, a mini-computer maker, was also into PABXs, the local telephone exchanges used internally by many companies and organisations. On one such internal telephone system the company based a complete voice and data communications system that had, as its front end, a combination telephone and computer system. This had all the interesting attributes one might expect to find in such a machine. Not only could it be



STATEMENT

used as a straightforward telephone for verbal communication, it could also be used as a computer, and to transmit data, electronic mail and all that stuff around the staff of the organisation. Naturally, it could do these things simultaneously, so that one staff member could discuss data and information in real-time mode with another.

There were two major drawbacks to this system, as I remember from those dim and distant days: one was that the telephone system in West Germany, like most of the others around the world, couldn't cope with the level or type of communications traffic such a system would produce (if implemented widely); the other being that it was considerably negative in its cheapness rating. That is hardly surprising, I suppose. After all, it was one of the first, and at least partially experimental in nature.

Since that time, however, things have started to change. Many telecommunications authorities around the world have begun the long process of physically taking the information technology theories into the bosom of their corporate hearts. The infrastructure needed to cope with the type of communications traffic smart phones are going to produce is now either in place, or at least planned for. So now, the smart phones dedicated to the purpose can start to appear.

No sooner said, of course, than done. One of the first to come to my notice has come from Televideo in the dear old US of A. This company, best known for its display terminals but with a recent track record of producing interesting business microcomputers, has just introduced what it calls a personal terminal. This is a screen-based machine, with keyboard and (admittedly still optional) modem and telephone attachment.

Another system, this time with integral modem and telephone handset, comes from a British company, BCD Telemail. This one has received a £200,000 investment from Imperial Life Assurance of Canada which is interesting, for once the likes of insurance companies and property corporations start investing in products like this, one can assume that the technology, the companies and the market are being considered relatively 'safe'.

What these latest introductions have in common with the Nixdorf system of all those years ago is that they are

primarily directed towards business applications. This is probably only as it should be, for it is the business community that has the money to spend on purchasing sophisticated machinery that makes life easier.

But as with other aspects of computing, there are parallels here with the hobbyist/home user/computer freak and the influence of such people on microcomputers. As it was in the beginning, so it is now. It was the hobbyists and freaks that started the whole microcomputer business in the first place. Today it's the hobbyists and home users that are leading the industry along.

Many companies in the business will not believe that there is a market for such communications-oriented hardware. Others will not believe that the time is yet right for such products. Others, still, will be prepared to gamble, and it is a gamble that I feel could easily pay off, and pay off now.

There are two immediately predictable types of system that can be foreseen coming from the industry. Equally predictably, they will be a business machine and a home user machine.

The business system is the easiest to specify, if only because all the technical bits of hardware and software needed for a basic machine are now available. It will be a complete box, incorporating screen, keyboard, processor/memory, disk drives and maybe even a printer. To this basic computer configuration will be added an integral modem and a full telephone handset system with all the necessary gizmos.

On the software side it will, for better or worse, require some compatibility with the IBM PC and need to feature some degree of concurrent operational capability. This latter will be essential if the slow speed of communication is not to constipate the machine totally. Ideally, it will have a more powerful processor than the Intel 8088 which powers the IBM PC. This will be able to emulate the 8088 for compatibility, but will be able to grow into other, more powerful operating system areas.

A major advantage of telecommunications is a dramatic increase in locational flexibility and so it is safe to expect a portable computer as an essential member of any serious manufacturer's product portfolio.

The home front machine is more

difficult to predict, if only because just about any strange applications idea is likely to be successful. Here, the physical relationship between the two elements of computer and telephone could possibly be reversed. Instead of the phone being an adjunct to the computer, in the home machine the computer could be an adjunct of the phone. The type of application where this structure might arise is anywhere the phone is used as the prime medium, with the computer providing essential, but secondary facilities. For example, this could be in the classic application of teleshopping, where the bulk of the communication could still be verbal (if only to a speech synth/recognition computer) with the home machine providing the essential services of handling banking transactions, logging orders and printing out confirmation slips during the 'conversation'.

This is a shift in emphasis that I see coming in much of home computing. For the present the computer is important in its own right, but I feel that will change. After all, we admire the labourer and the hole, not the shovel. For the games players, computers will be built into the television sets, and the games will come from the broadcasting companies (if they have an eye for a fast profit).

In most other home applications, the computer is similarly unimportant of its own accord. It is what the thing does that's important, and what it does will normally best be integrated into the 'where' it does it. That will mean a telephone that just happens to have a computer built into it.

All this could be academic of course. The USA is the single biggest market for products of this type, and in telecommunications that used to mean that American Telephone and Telegraph (AT&T) was the sole arbiter of what happened to and with the phone system. The US phone system is now being deregulated, and AT&T's monopoly is being broken up. One US company slightly pleased about this is none other than IBM, which has wanted to break into the mainstream phone business for years. Now it has the chance and is poised to take it.

There is just the chance that having IBM compatibility may not be just 'advisable' for smart phone manufacturers. It could end up as the order of the day. Ah, well.

APOLOGY

To other retailers, but we must clear on overstocked lines

PAPER \$29.00 Box (inc tax)
15" Continuous Good Quality 2000 Sheets per box

APPLE Compatible Boards
ALL NEW from **\$49** each

DISKETTES
TOP BRAND Box of 10, 5 year Guarantee **\$29** per box (inc tax)

COMPUTER TAPES
Certified error free with blank labels, in boxes of 10
\$9.80 per box (inc tax)

COMMODORE EXECUTIVES
Portable Color Computers 64K built in Drive Monitor etc
\$1285.00

Commodore games
Cartridge Most @ **\$19.95** (inc)

DATA PARTS

11 Edward Street, Shepparton
Telephone: 21 7155 (058)

Add \$2.00 for delivery anywhere in Australia.
Except paper.
Note: Freight charges applicable only on these specials



Things have been disruptive over the last few months at APC. First came the move from our dog-box at Clayton to the relatively palatial surroundings of our "shop" at Elwood. Then the publisher thought it'd be good for the magazine, the readers, the staff, the advertisers and (oh, yes) himself if he got a big publisher involved in pumping out the largest micro mag in Australia each month. So APC is no longer published by Sean Howard Productions. While the name of the new publisher remains a mystery (or at least a secret of the Corporate Affairs Office which is carefully weighing up the pros and cons of allowing the proposed new company name to be registered), we can tell you the new majority owner of APC is ACP (Australian Consolidated Press). In addition to confusion, these goings-on prevented the usual Chip Chat contributors from spending time dredging the industry pool to bring you the bitching and backstabbing known and loved by this column's readers. Anyhow, Chip Chat's back ready to serve up heaps.

Let's deal with the home camp first, and then go on to extract the Michael from everybody else.

The front cover of the December issue of APC (a couple of nymphs on the beach, each with a PC) got a bit of a canning from our female readers and the odd congratulatory, though tongue in cheek, note from the men. Refer to Communications for samples. The

only point we're going to make, for what it's worth, is that the same 'sexist' cover accompanied the highest ever sale of APC — over 25,000 copies! Even so, we won't be doing it again. There's far too much sexism, agism, sizism, languagism and all sorts of other isms in this business already . . .

The 2nd APC Show proved a stunner despite its ups and downs, from people with something to moan about to people moaning because they hadn't anything to moan about. The latter group was in the vast majority so congratulations and credit to Graeme Selby of Australian Exhibition Services who organised the event. Even though more people attended (26,000 vs last year's 22,000) gone were the queues and crowded entrance area. Responsibility for this is shared by the extra day the Show was open, separate entrance and exit and more ticket sales points. The air conditioning was better, and with reduced crowd ing the Show was an even better venue for micro sellers.

The Show served other purposes as well. It gave out of town journo's the chance to taste the night life of the premier city. Libel laws prevent us publishing a series of photographs (shot by one of our excited reporters) showing just such a journalist from a Certain Other Magazine lurking on the streets of the Cross. Don't ask why our reporter was there, and with a camera too . . .

ADVERTISERS INDEX

ACT..... OBC	Compak Computer	High Technology 143	Prentice-Hall..... 117
A&M Computer	Centre..... 14,15,167	Home Computers..... 92	President Computers.... 84,85
Solutions..... 10,71	Complete Solutions 1	KJ Computer Services 167	Program Unlimited 103
Amust..... 5	Compsoft Australia	K Lam..... 171	PSI Paperwork Systems 65
Applied Technology..... 78,79	(Brisbane)..... 140	Last Word..... 177	Pulsar Electronics..... 74
Arbiter Electronics..... 29	Computer Edge..... 53-56	Logical Solutions 21	Robs Computer Centre... 18,19
Arcom Pacific..... 154	Computer Galerie..... 29	Lothlorien Software..... 170	Rod Irving..... 124
Ashton Scholastic..... 48	Computer Play..... 177	Lysco..... 166	Rolvi..... 13
ASP..... 165	Computer Simulations... 170	Maxwell Office Equipment... 12	JW Ross..... 6
Australia Computer	Computer Technics..... 37	Melbourne	SCA Software Corporation
Software..... 94	Computerware..... 166	House..... 80,158,159	of Australia..... 83
Australian Exhibition	Country Soft..... 177	Memorex..... IBC	Scarlan..... 104
Services..... 90	CPM Data Systems..... 130	Merton Scott..... 45	SD Computer Research..... 82
Automation Statham..... 100	CW Electronics..... 40	Metropolitan Business	Softpac Enterprises..... 168
Barson Computers... 8,9,34,35	Danish Documentation	Machines..... 25	Software
Bayne & Trembath..... 81	Standard..... 181	Microbuff	Concepts..... Centre Spread
Brother Industries..... 32	Data Parts..... 22,23,171,184	Computers... 59,63,69,156	Southern Cross Resources... 95
BS Microcomp..... 101	Deforest Software..... 114	Micro Educational..... 46,47	Southpac..... 106
BVP..... 72	Digital Source	Micro 80..... 24	Spectravideo..... 136
CAE..... 94	International..... 61	Micromail..... 86,87,98,99	System Solutions..... 102
Calcutronic..... 92,115	Direct Data..... 45	Micromedia..... 168	Tardis Computers..... 64
Case Communications..... 144	Eastern Micro	Micro Nationwide..... 92	Tech-Rentals..... 109
Caulfield Business	Electronics..... 38,39	Micropro Computers... 73,111	The Computer Spot..... 133
Systems..... 36	Emerald Hill Computer	Microprogramming..... 20	The Independent Micro
Centre Industries..... 76	Brokers... 123,125,127,129	Nashua..... 152	Computer Group..... 6
Chambers Photo Studio... 169	Emona Computers..... 128	New Generation..... 171	Think Computers..... 81
City Personal Computers... 17	Energy Control..... 168	Nissei Sangyo..... 163	3M..... 138
Commercial & Professional	Entercom..... 126	Osborne..... IFC,88,89	Uni Co-op Bookshop..... 43
Microsystems..... 7	Gametronics..... 96	Padmede..... 77	Video Technology..... 166
Commodore Computer..... 155	GS Webber & Associates... 82	Perimedia..... 64	Zygotech..... 11

Memorex reliability, the inside story.

Vast experience, renowned reliability and technological supremacy of the world's leading computer media manufacturer contribute to the story inside every pack of Memorex flexible discs.

The extensive research, exhaustive testing and stringent quality control procedures which surround every Memorex product ensure that

Memorex users have the most reliable flexible disc on the market. Every track of every disc is 100% error free tested.

Use Memorex flexible discs and you'll discover that our "inside story" is not just another "tall story".

Special soft polyester liner constantly cleans disc during use.

Unique burnishing process provides ultra smooth surface for better head to disc contact and reduced head wear.

The Memorex name is your assurance of the ultimate in quality and reliability.

Coating uses the latest oxide technology, optimising signal output and recording accuracy.

Precision applied plastic hub ring protects disc edge from damage.

The carefully applied Memorex serial number allows identification of each disc.

Extra stiff glue bonded jacket ensures greater reliability, lower disc torque and easy loading.

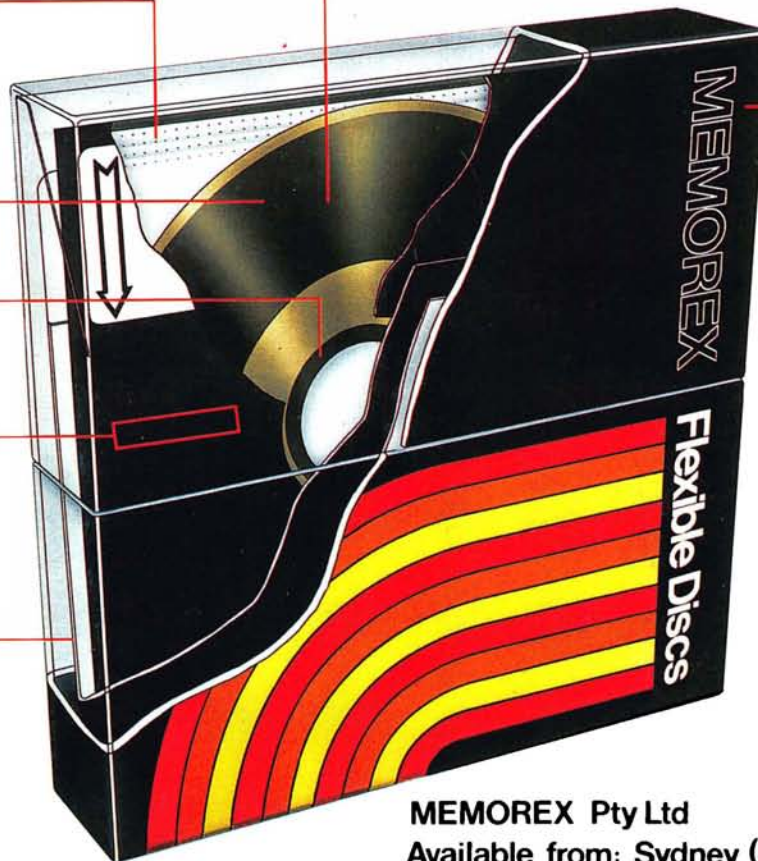

MEMOREX Pty Ltd

Available from: Sydney (02) 908-2211

Melbourne (03) 267-2955

Or a Distributor near you

MEMOREX

A Burroughs Company

We Have The Answer To Your Storage Problems

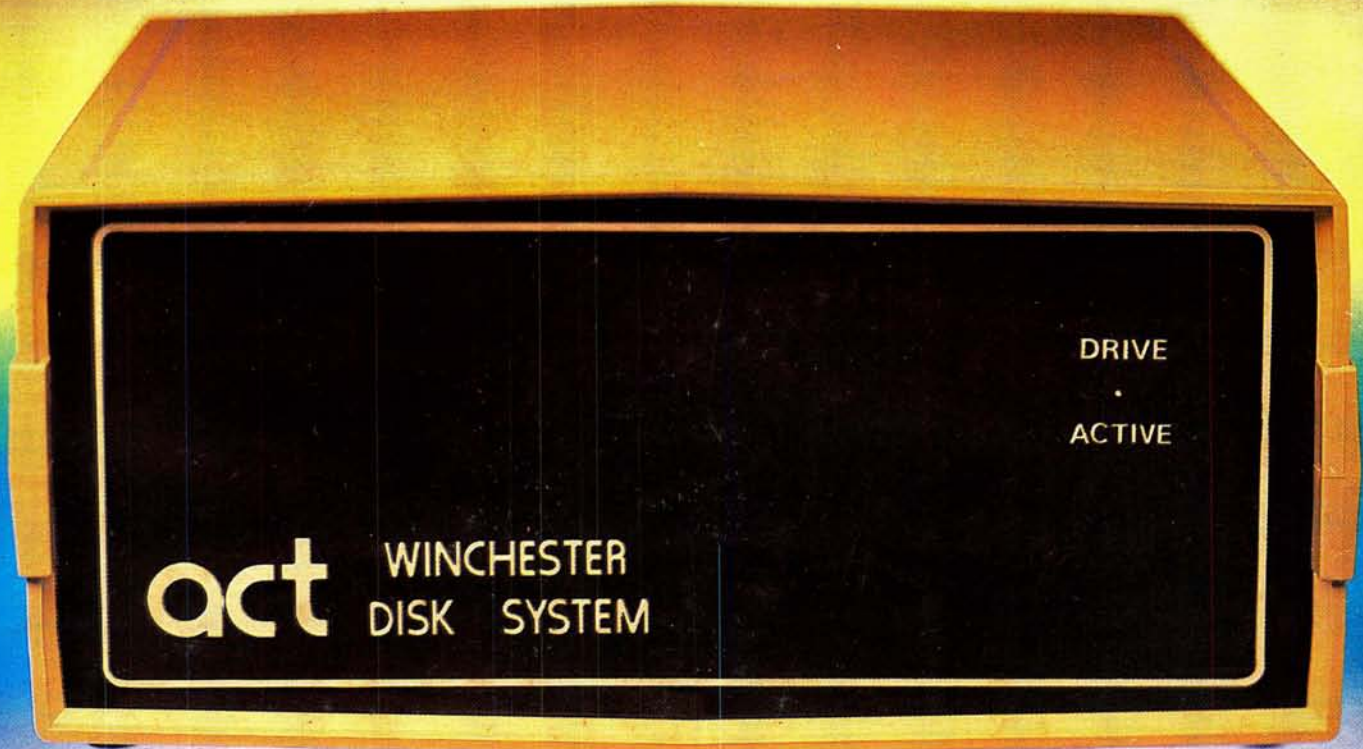

Take a hard line on software with the ACT WINCHESTER HARD DISK SYSTEM

THE POWERFUL ACT

The ACT Hard Disk System upgrades your computer to a powerful high performance machine. Supported throughout Australia, the ACT HARD DISK is the answer to your storage problems. ACT, the affordable hard disk system.

THE RELIABLE ACT

Far greater storage than floppy drives with reliable performance under all conditions, makes the ACT Hard Disk unbeatable value. Designed and manufactured in Australia.

*5-31 Megabytes of Hard Disk Storage.
5 Plus 5 Fixed/Removable Hard Disk.
5 Megabytes Removable Hard Disk Cartridge.*

THE LOGICAL ACT

The obvious choice for your micro, the ACT HARD DISK is now available for:
APPLE II • IBM PC • DEC RAINBOW
• PEACH • KAYPRO • OSBORNE
• MICRO • DECISION • MICROBEE
• HEATH ZENITH • NORTHSTAR
• SANYO • SUPERBRAIN • TANDY
• TIME OFFICE • TOSHIBA • XEROX
• S-100 • SIGMA OKI • SIRIUS • NEC APC.
New Releases: MCB-550 & OKI Model 30.

THE SHAREABLE ACT — PC NET

PC Net is a hard disk sharing system — simple and cost effective. The disk is divided into logical drives, allowing independent users to share the disk. Available for most popular brands of microcomputer.

N.S.W.

75 Willoughby Road,
Crows Nest, NSW 2065
Phone: (02) 439 6300
Telex: AA 24816

S.A.

COMPUTERMART PTY LTD,
123 Gouger Street,
Adelaide, SA 5000
Phone: (03) 51 5363, 212 2888

VIC

DIRECT DATA
1065 High Street,
Armadale, Vic 3143
Phone: (03) 20 6949

DEALER ENQUIRIES WELCOME